

# User & Installation Manual

## LT-3100S GMDSS Satellite Communications System

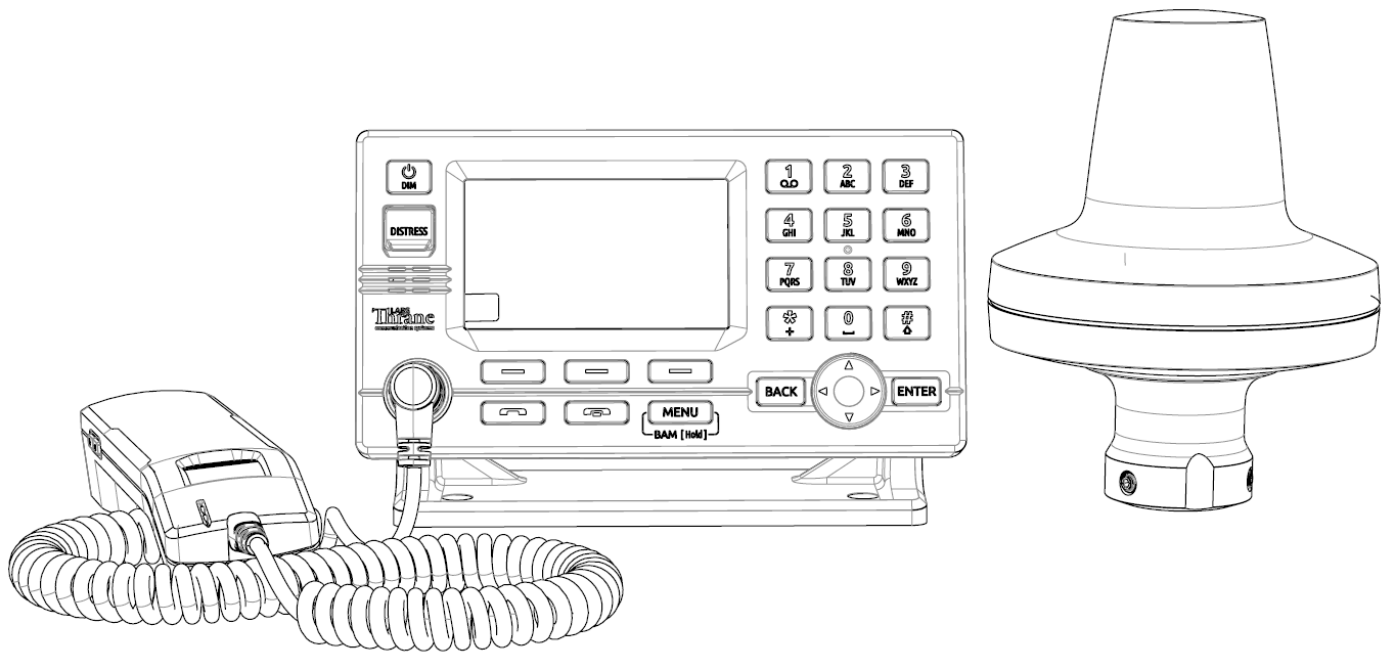

Document Number: 95-102251 Rev. 1.03

Release date: December 15, 2020

Copyright © Lars Thrane A/S

Denmark

ALL RIGHTS RESERVED



**This Document is of © copyright to Lars Thrane A/S. It contains proprietary information, which is disclosed for information purposes only. The contents of this document shall not in whole or in part be used for any other purpose without prior permission from Lars Thrane A/S.**

## Disclaimer

Any responsibility or liability for loss or damage in connection with the use of this product and the accompanying documentation is disclaimed by Lars Thrane A/S. The information in this manual is provided for information purposes only, is subject to change without notice, and may contain errors or inaccuracies. Manuals issued by Lars Thrane A/S are periodically revised and updated. Anyone relying on this information should acquire the most current version e.g. from Lars Thrane A/S. Lars Thrane A/S is not responsible for the content or accuracy of any translations or reproductions, in whole or in part, of this manual from any other source.

## Copyright

© 2020 Lars Thrane A/S. All rights reserved.

## Disposal

Old electrical and electronic equipment marked with this symbol can contain substances hazardous to human beings and the environment. Never dispose these items together with unsorted municipal waste (household waste). In order to protect the environment and ensure the correct recycling of old equipment as well as the re-utilization of individual components, use either public collection or private collection by the local distributor of old electrical and electronic equipment marked with this symbol. Contact the local distributor or dealer for information about what type of return system to use.



## IMO and SOLAS

The equipment described in this manual is intended for use on commercial marine and leisure vessels. The equipment is covered by the International Maritime Organization (IMO) and Safety of Life at Sea (SOLAS) regulations.

## **Safety Instructions for the Installer**

The following safety instructions must be observed during all phases of operation, installation, service and repair of this equipment. Failure to comply with these precautions or with specific warnings elsewhere in this manual violates safety standards of design, manufacture and intended use of the equipment.

Lars Thrane A/S assumes no liability for the customer's failure to comply with these requirements.

### Instructions for the Installer

#### **WARNING - Product installation**

To ensure correct performance of this equipment, it is strongly recommended that professionals with expertise, properly trained, and likewise authorized within the industry is completing the installation.

#### **WARNING - Explosive atmosphere**

Do not operate the equipment in the presence of flammable gases or fumes. Operation of any electrical equipment in such an environment constitutes a definite hazard.

#### **WARNING – Turn off power switch**

Turn off the main power switch before installing the equipment described in this manual. Do not connect or disconnect equipment when the main power switch is on.

#### **WARNING - Compass safe distance**

The compass safe distance for standard and steering compasses is 1.0 m (3.3 ft) and 0.9 m (3.0 ft) respectively. Observe these distances to prevent interference to a magnetic compass.

#### **WARNING – Input Power**

The input voltage range is: 12-24 VDC.

#### **WARNING – Power supply protection**

Make sure that the power supply is adequately protected by a fuse or an automatic circuit breaker when installing the equipment:

LT-3110S Control Unit (max. 15.0 A)

LT-3140S Interface Unit (max. 5.0 A)

#### **WARNING – DC circuit breaker**

DC circuit breaker must be used as ON/OFF switch for the Control Unit and Interface Unit.

#### **WARNING – Overcurrent protective**

Overcurrent protective devices used as safeguard (specific to IEC 62368-1) - Lars Thrane A/S has the responsibility of use of non-IEC approved fuses in the equipment.

**If the safety precautions and warnings on this site are not followed, warranty will be void.**



## **Safety Instructions for the Operator**

The following safety instructions must be observed during all phases of operation, installation, service and repair of this equipment. Failure to comply with these precautions or with specific warnings elsewhere in this manual violates safety standards of design, manufacture and intended use of the equipment.

Lars Thrane A/S assumes no liability for the customer's failure to comply with these requirements.

### **Instructions for the Operator**

#### **WARNING – Do not disassemble**

Do not disassemble or modify this equipment. Fire, electrical shock, or serious injury can result.

#### **WARNING – Keep away from live circuits**

Operational personnel must not remove product enclosure. Do not service the equipment with the communication cable connected. Always disconnect and discharge unit, cable and circuits before touching them.

#### **WARNING - Permanent watch**

In case of smoke or water leaks into the equipment, immediately turn off the power. Continued use of the equipment can cause fire or electrical shock. Keep access and permanent watch of the equipment in order to prevent any unwanted escalation.

#### **WARNING – DC mains connector**

The DC mains connector is to be used as the disconnection device to isolate the equipment from the mains supply.

#### **IMPORTANT - Safety distance**

The safety distance from the LT-3130 Antenna Unit, when the LT-3130 Antenna Unit is powered and transmitting, is 0.1 m (0.3 ft), in order to comply with the regional regulations.

Always keep this safety distance to the LT-3130 Antenna Unit to avoid any serious injury.

**If the safety precautions and warnings on this site are not followed, warranty will be void.**



**IMPORTANT – FCC Compliance Note:**

This equipment has been tested and found to comply with the limits for a Class B digital device, pursuant to part 15 of the FCC Rules. These limits are designed to provide reasonable protection against harmful interference in a residential installation. This equipment generates, uses and can radiate radio frequency energy and, if not installed and used in accordance with the instructions, may cause harmful interference to radio communications. However, there is no guarantee that interference will not occur in a particular installation. If this equipment does cause harmful interference to radio or television reception, which can be determined by turning the equipment off and on, the user is encouraged to try to correct the interference by one of the following measures:

- Reorient or relocate the receiving antenna.
- Increase the separation between the equipment and the receiver.
- Connect the equipment into an outlet on a circuit different from that to which the receiver is connected.
- Consult the dealer or an experienced radio/TV technician for help.

This product does not contain any user-serviceable parts.

Repairs should only be made by an authorized Lars Thrane A/S service center. Unauthorized repairs or modifications could result in permanent damage to the equipment and void your warranty and your authority to operate this device under Part 15 regulations.



**IMPORTANT – FCC Compliance Note:**

This device complies with the GMDSS provisions of part 80 of the FCC rules.



**IMPORTANT – Innovation, Science and Economic Development Canada Compliance Note:**

This device complies with Innovation, Science and Economic Development Canada license-exempt RSS standard(s). Operation is subject to the following two conditions: (1) this device may not cause interference, and (2) this device must accept any interference, including interference that may cause undesired operation of the device.

## Required information for the reader

Throughout this document, essential information will be presented to the reader. The following text (emphasized) has the following meaning and/or implication:

**WARNING:** A 'Warning' is an Operation or Service procedure that, if not avoided, may cause a hazard situation, which could result in personnel death or serious injury.

**IMPORTANT:** Text marked 'Important' provides essential information to the reader and is key information to the user for the equipment to work properly. Damage to the equipment can occur if instructions are not followed.

**NOTE:** A 'Note' provides essential information to the reader.

## **About this manual**

### **Intended readers**

This is a User & Installation Manual for LT-3100S GMDSS Satellite Communications System, or LT-3100S GMDSS system. The manual is intended for installers and service personnel, as well as operations of the system (~users).

Personnel installing or servicing the system should be professionals with technical expertise, properly trained, and likewise authorized.

All safety instructions and guidelines in this manual must be observed. The safety instructions are listed in the beginning of the manual. The guidelines are to be found in the separate chapters, where it is needed.

## Software versions

This manual is applicable to the following software:

Software Versions	
Description	Version
LT-3100S GMDSS System	1.02R

*Table 1: Software Versions*

**NOTE:** The LT-3100S GMDSS system will be released to customers with the initial software version 1.02R. Software version 1.02R includes support for all GMDSS Safety Services provided by Iridium®. Additional, non-GMDSS services might be added in later software releases. Please contact Lars Thrane A/S for details about future software releases and features.

## Record of Revisions

Rev.	Description	Release Date	Initials
1.00	Original document.	December 05, 2020	PT
1.01	Editorial corrections.	December 07, 2020	PT
1.02	Editorial corrections.	December 09, 2020	PT
1.03	The following sections are updated: <ul style="list-style-type: none"> <li>• <i>App. H - Specifications</i>: LT-3130 Antenna Unit operational temperature for 12 VDC and 24 VDC input power.</li> </ul>	December 15, 2020	CT

## Table of Contents

<b>Introduction</b> .....	1
<b>Application and Limitations</b> .....	2
<b>Unpacking (in-the-box)</b> .....	3
<b>Inspection</b> .....	3
<b>Accessories</b> .....	4
<b>GMDSS parts</b> .....	4
<b>SSAS parts</b> .....	4
<b>Mounts</b> .....	4
<b>Cable and connectors</b> .....	5
<b>System Overview</b> .....	6
<b>Installation and Mounting</b> .....	7
<b>LT-3110S Control Unit</b> .....	7
<b>LT-3120 Handset</b> .....	10
<b>LT-3121 Cradle</b> .....	11
<b>LT-3130 Antenna Unit</b> .....	12
<b>LT-3140S Interface Unit</b> .....	20
<b>LT-3150S Alarm Panel</b> .....	21
<b>LT-3160S Printer Adapter</b> .....	23
<b>Bracket Mount, Antenna Unit</b> .....	24
<b>Pole Mount, Antenna Unit</b> .....	27
<b>Interfaces</b> .....	29
<b>LT-3110S Control Unit</b> .....	29
<b>LT-3130 Antenna Unit</b> .....	37
<b>LT-3140S Interface Unit</b> .....	39
<b>Power Consumption</b> .....	43
<b>Maximum</b> .....	43
<b>Average (transmission/reception)</b> .....	44
<b>DC Isolation Resistance and Chassis Ground</b> .....	45
<b>User Interface (UI)</b> .....	47
<b>Display</b> .....	48
<b>Menu System</b> .....	52
<b>Activating the System</b> .....	54
<b>Acquire a GMDSS SIM card</b> .....	55

Maritime Safety Service Activation Form (MSSAF) .....	55
Who's My Service Provider .....	56
Installation Wizard.....	57
Radio Survey .....	66
<b>Change of Hardware and Software .....</b>	<b>67</b>
Change of Hardware .....	67
Software update .....	68
Service Wizard.....	69
<b>GMDSS Services .....</b>	<b>70</b>
Distress Alert & Distress Call .....	71
Distress Alert Relay.....	77
Maritime Safety Information (MSI).....	80
Safety Calling.....	84
Two-digit Codes .....	87
Safety Messaging .....	89
<b>GMDSS Submenu .....</b>	<b>93</b>
Safety Contacts .....	94
MSI Schedule.....	95
MSI Settings .....	98
Distress Settings.....	104
Position Settings .....	108
Location Information .....	112
SES Information.....	115
Terminal Test .....	117
<b>System Services.....</b>	<b>120</b>
General Calling.....	120
General Messaging (SMS).....	126
External SIP Phones .....	131
Analogue Phone Adapter.....	133
Modem Data .....	134
Tracking.....	135
<b>System Submenus.....</b>	<b>138</b>
Phone .....	138
Settings.....	139

System .....	143
Bridge Alert Management (BAM).....	148
Serial Interface (RS-422) .....	152
GNSS sentences.....	152
BAM sentences .....	153
MSI sentences .....	154
GMDSS Printers.....	155
Web server .....	156
Accessing the built-in web server.....	157
Dashboard .....	158
Configuration .....	159
Software update .....	176
Diagnostic.....	177
Legal notice .....	178
Log out.....	178
Disable login timeout.....	178
Service & Repair.....	179
Appendixes.....	180
App. A - Applicable Standards .....	180
App. B - Bridge Alert Management (BAM).....	181
App. C - Multiple talkers and multiple listeners .....	190
App. D - GNSS sentences .....	191
App. E - BAM sentences.....	193
APP. F - MSI sentences.....	195
App. G - GNSS Receiver Integrity States (Automatic GNSS) .....	197
App. H - Specifications .....	202
App. I - Outline Drawing: LT-3110S Control Unit .....	204
App. J - Outline Drawing: Bracket Mount, Control Unit.....	205
App. K - Outline Drawing: Flush Mount, Control Unit.....	206
App. L - Outline Drawing: LT-3130 Antenna Unit.....	207
App. M - Outline Drawing: LT-3140S Interface Unit .....	208
App. N - Outline Drawing: LT-3150S Alarm Panel.....	209
App. O - Outline Drawing: LT-3160S Printer Adapter.....	210
App. P - Outline Drawing: Pole Mount, Antenna Unit.....	211



<b>App. Q - Outline Drawing: Bracket Mount, Antenna Unit.....</b>	<b>212</b>
<b>App. R - Outline Drawing: LT-3120 Handset .....</b>	<b>213</b>
<b>App. S - Outline Drawing: LT-3121 Cradle.....</b>	<b>214</b>
<b>App. T - Conformity.....</b>	<b>215</b>

## Introduction

Congratulations on your purchase of the LT-3100S GMDSS Satellite Communications system!

The LT-3100S GMDSS Satellite Communications system is a maritime satellite communication product from Lars Thrane A/S. The LT-3100S GMDSS system is designed for the professional market (deep sea, fishing, and workboats), but can be used for the leisure market as well. The LT-3100S GMDSS system meets all standards and certification requirements needed for worldwide maritime satellite communication equipment.

The LT-3100S GMDSS system has voice and data capabilities with 100% global coverage provided by the Iridium® Communications Network. The LT-3100S GMDSS system offers the following Iridium® GMDSS Safety Services:

- Distress Alert & Distress Call
- Distress Alert Relay
- Maritime Safety Information (MSI)
- Safety Calling
- Safety Messaging

The LT-3100S GMDSS system - basic consists of a control unit, antenna unit, handset and cradle. The additional GMDSS system units available are: LT-3140S Interface Unit, LT-3150S Alarm Panel, and LT-3160S Printer Adapter.

A single coaxial cable connects the control unit with the antenna unit. Using a standard coaxial cable, up to 500 meters of separation between the units can be obtained, giving freedom to mount the antenna unit in the best possible location, with free line of sight to the Iridium satellites.

The LT-3100S GMDSS system can be used as the primary satellite communication product on vessels, covering the basic communication needs in terms of connectivity between the ship and shore and ship to ship.

## Application and Limitations

- The LT-3100S GMDSS system shall be installed according to manufacturer's User & Installation Manual.
- The LT-3100S GMDSS system includes an integrated Global Navigation Satellite System (GNSS) receiver for position fixing.
- The LT-3100S GMDSS complies with the requirements for Other Network Function (ONF) as defined in IEC 61162-450 (2018)
- The LT-3100S GMDSS can be used for GMDSS services in Sea Areas A1, or A2 or A3 defined by SOLAS 1974 as amended, where Flag states have recognized Iridium as a mobile satellite service for use in the GMDSS.
- The LT-3100S GMDSS complies with the requirements for reception of MSI through the Iridium SafetyCast service, and can be used for compliance with the carriage requirements for EGC when such services are made available through the Iridium satellite system.
- The LT-3130 Antenna Unit operational low temperature is:
  - -30°C (-22°F) when using 12 VDC input power on the LT-3110S Control Unit
  - -40°C (-40°F) when using 24 VDC input power on the LT-3110S Control Unit

## Unpacking (in-the-box)

Unpack the LT-3100S GMDSS Satellite Communications System – Basic (P/N: 90-102071) and check that the following items are present in the box:

- 51-101812 LT-3110S Control Unit
- 51-100988 LT-3120 Handset
- 51-101181 LT-3121 Cradle
- 51-100989 LT-3130 Antenna Unit
- 91-100771 Bracket Mount, Control Unit
- 91-102118 Power Cable, 3m
- 4 x Stainless steel A4 screws (for Bracket Mount, Control Unit)
- 2 x Stainless steel A4 screws (for Cradle)
- 4 x Unit Test Sheets
- 95-102251 LT-3100S GMDSS User & Installation Manual

**NOTE:** Antenna unit mounts (bracket and pole mount) are not included in the LT-3100S GMDSS Satellite Communications System – Basic (P/N: 90-102071) and must be ordered separately. The antenna unit must only be mounted, using the bracket or pole mount, delivered by Lars Thrane A/S. The antenna unit mounts are listed with part numbers (P/N) in *Accessories on page 4*.

### Inspection

Inspect the shipping cartons and/or wooden box immediately upon receipt for evidence of damage during transport. If the shipping material is severely damaged or water stained, request that the carrier's agent is present when opening the cartons and/or wooden box. Save all box packing material for future use.

After unpacking the system and opening the cartons, inspect it thoroughly for hidden damage and loose components or fittings. If the contents are incomplete, if there is mechanical damage or defect, or if the system does not work properly, notify your distributor.

**WARNING:** To avoid electric shock, do not apply power to the LT-3100S GMDSS system components if there is any sign of shipping damage to any part of a unit or the outer cover. Read the Safety Instructions at the front of this manual before installing or operating the system.

## Accessories

### GMDSS parts

The following GMDSS parts are not part of the basic system and must be ordered separately:

- 51-101814 LT-3140S Interface Unit
- 51-101815 LT-3150S Alarm Panel (incl. 25m cable)
- 51-101816 LT-3160S Printer Adapter (incl. 25m cable)

### SSAS parts

The following SSAS parts are not part of the basic system and must be ordered separately:

- 91-102073 SSAS Alert Button (incl. 50m cable)
- 91-102074 SSAS Test Button (incl. 50m cable)

### Mounts

The following Mount parts are not part of the basic system and must be ordered separately:

- 91-100772 Flush Mount, Control Unit
- 91-100773 Bracket Mount (1.5" to 2.5" pipe), Antenna Unit -> *to be discontinued*
- 91-102469 Bracket Mount (1.5" to 2.5" pipe), Antenna Unit with Cable Hose
- 91-102470 Cable Hose (standalone)
- 91-100774 Pole Mount (1.5" pipe), Antenna Unit

In order to avoid corrosion when using the Bracket Mount (1.5" to 2.5" pipe), we have introduced a Cable Hose for the antenna unit, which is recommended to use for all installations using this mount. The Cable Hose is illustrated in Figure 28 on page 26.

### Cable and connectors

The following cable and connector parts are not part of the basic system and must be ordered separately:

- 91-100768 Aux Cable, 3m
- 91-101183 Coaxial cable Ø4.9mm, 10m
- 91-101184 Coaxial cable Ø4.9mm, 25m
- 91-101137 Coaxial Cable Ø10.3mm 10m
- 91-101138 Coaxial Cable Ø10.3mm 25m
- 91-101139 Coaxial Cable Ø10.3mm 50m
- 91-101140 N Conn. (male) for Coaxial Cable Ø4.9mm
- 91-101186 N Conn. (male) for Coaxial Cable Ø10.3mm
- 91-101187 Crimping Tool for Coaxial Cable Ø4.9mm
- 91-101188 Crimping Tool for Coaxial Cable Ø10.3mm

Coaxial cables are delivered with one fixed N connector (outdoor mounting), another loose N connector and crimp parts comes with the cable. It is required to use an appropriate crimping tool for attaching the loose N connector.

**NOTE:** For further details on the cable and connectors, please contact Lars Thrane A/S. A coaxial cable up to a length of 500 meters can be used for connecting the LT-3110S Control Unit and the LT-3130 Antenna Unit. Details about the coaxial cable, specification and cable lengths, are described in *LT-3130 Antenna Unit* on page 37.

## System Overview

The LT-3100S GMDSS Satellite Communications System is a standalone communication product, which is using the Iridium® satellite constellation. The LT-3100S GMDSS system is working on the new Iridium® NEXT satellites. An overview of the LT-3100S GMDSS system is illustrated in Figure 1.

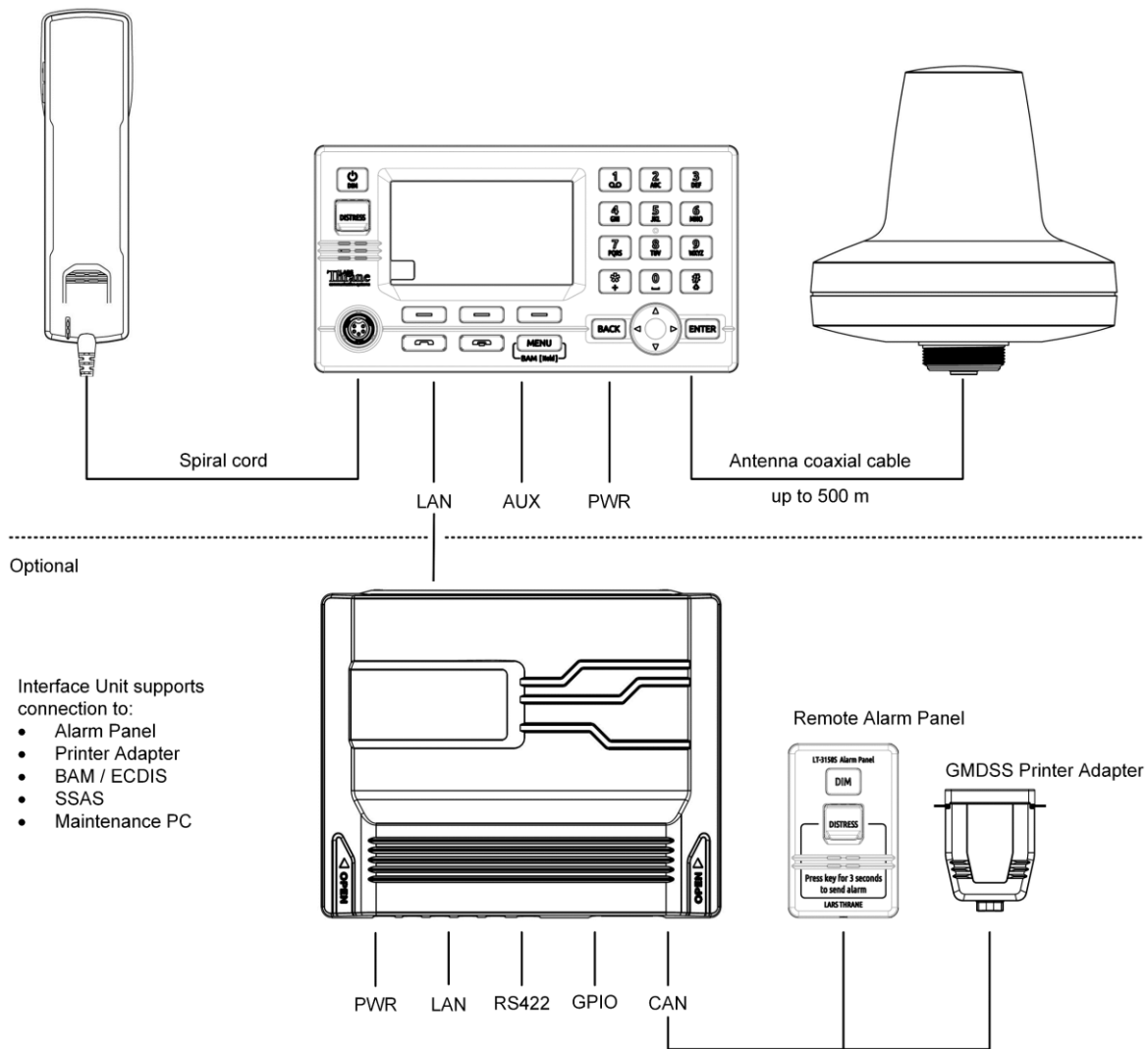

Figure 1: LT-3100S GMDSS system (units and interfaces)

The LT-3100S GMDSS system consists of the following units, provided by Lars Thrane A/S:

- LT-3110S Control Unit
- LT-3120 Handset
- LT-3121 Cradle
- LT-3130 Antenna Unit
- LT-3140S Interface Unit
- LT-3150S Alarm Panel
- LT-3160S Printer Adapter

## Installation and Mounting

### LT-3110S Control Unit

The LT-3110S Control Unit is the master unit in the system, supporting external interfaces and the operational user interface. The LT-3110S Control Unit is designed for indoor mounting. See the specifications in *App. H - Specifications* on page 202.

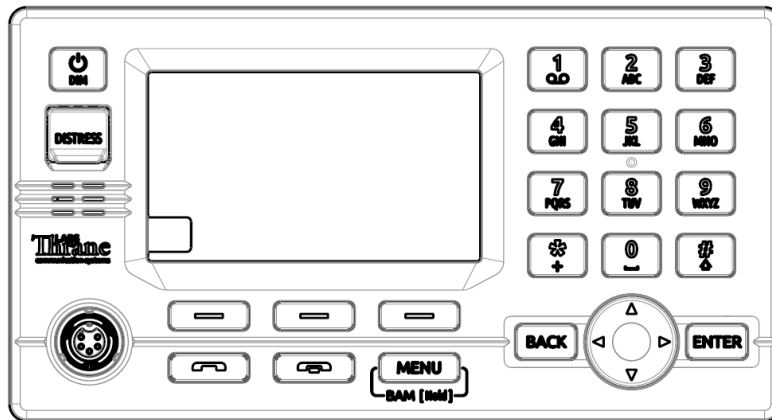

Figure 2: LT-3110S Control Unit (front view)

The LT-3110S Control Unit has the following interfaces:

- 4-pin power connector (male), marked 'PWR'
- Chassis ground connector, marked 'GNDC'
- N connector (female) for coaxial cable to the LT-3130 Antenna Unit, marked 'ANT'
- Ethernet (RJ-45) connector, marked 'LAN'
- 10-pin auxiliary connector (male), marked 'AUX'
- SIM card holder, marked 'SIM'
- 5-pin connector (female) for LT-3120 Handset (front of the control unit)

The interfaces on the back side of the LT-3110S Control Unit are illustrated in Figure 3 on page 8.



The LT-3110S Control Unit interfaces are described in *Interfaces* on page 29. The LT-3110S Control Unit, front and back view, are illustrated in Figure 2 and Figure 3.

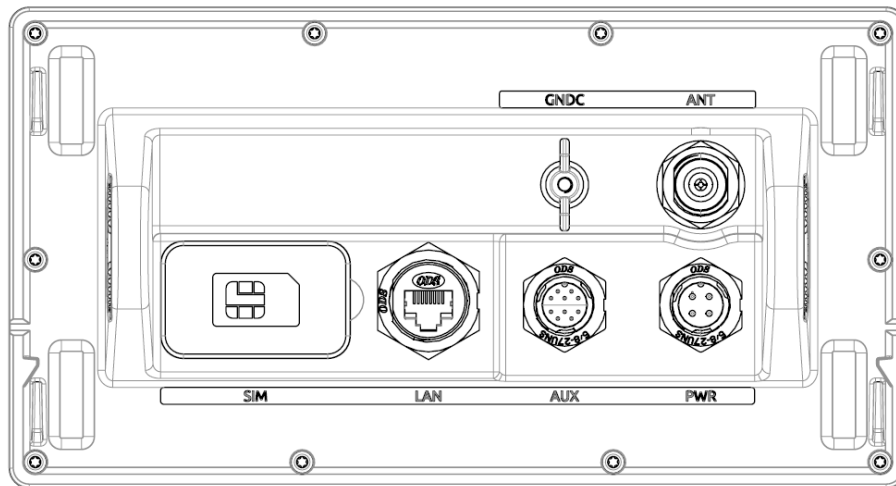

Figure 3: LT-3110S Control Unit (back view)

The LT-3110S Control Unit user interface, display and buttons, are described in *User Interface (UI)* on page 47.

**NOTE:** The LT-3110S Control Unit must be mounted with either the Bracket Mount, Control Unit (P/N: 91-100771) or Flush Mount, Control Unit (P/N: 91-100772) - illustrated in Figure 4 and Figure 5. The Flush Mount, Control Unit is not included in the LT-3100S GMDSS Satellite Communications System – Basic (P/N: 90-102071) and must be ordered separately.

#### Mounting and installation considerations:

For optimum system performance, the following guidelines on where to install and mount the LT-3110S Control Unit must be followed. It is recommended to mount the unit in a location, which fulfills these requirements:

- Mount the unit indoor (not exposed to direct water)
- Mount the unit using either the bracket mount or flush mount
- Mount the unit on a rigid structure with a minimum of exposure to vibration and shock
- Mount the unit in an area with an ambient temperature between -15°C to +55°C (+5°F to +131°F)

The Bracket Mount and Flush Mount for the LT-3110S Control Unit are illustrated in Figure 4 and Figure 5.

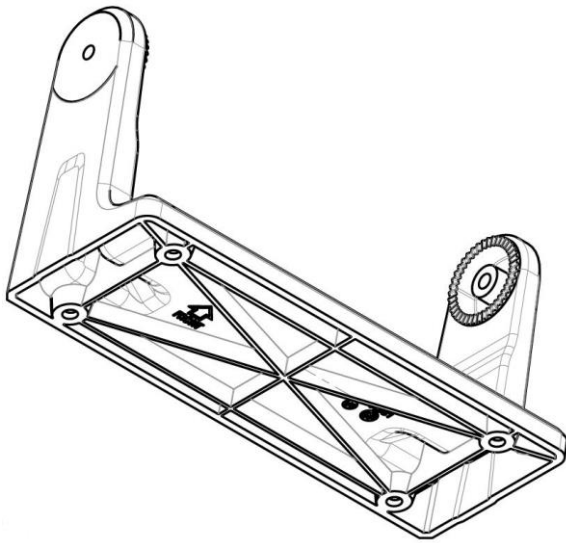

Figure 4: Bracket Mount, Control Unit.

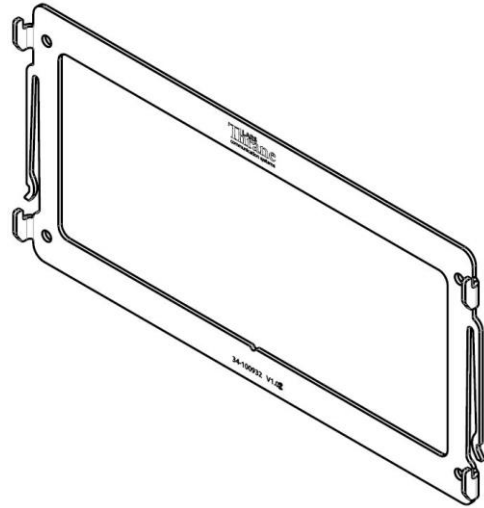

Figure 5: Flush Mount, Control Unit.

### LT-3120 Handset

The LT-3120 Handset is the primary voice interface for the LT-3100S GMDSS system. The LT-3120 Handset must be connected on the front of the LT-3110S Control Unit. The connector is illustrated in Figure 2 on page 7.

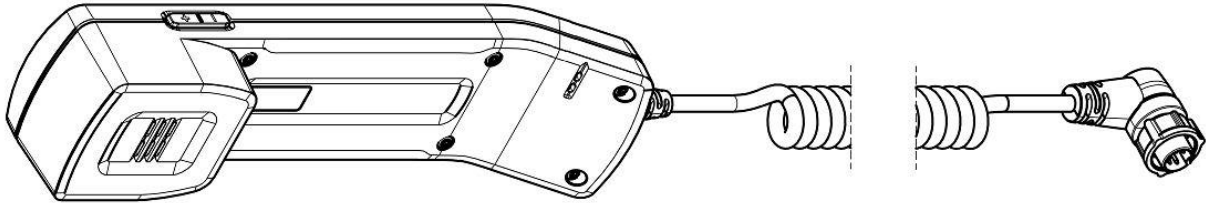

Figure 6: LT-3120 Handset (front view)

The LT-3120 Handset is connected to the LT-3110S Control Unit via a 5-pin proprietary angle connector. The spiral cord, fixed to the LT-3120 Handset is ~ 0.4 m from handset to connector, when coiled. The spiral cord can be stretched to a maximum of 2 m. The LT-3120 Handset is designed for indoor mounting. Check the specifications in *App. H - Specifications* on page 202.

The LT-3120 Handset has the following characteristics:

- High-performance audio speaker and microphone
- Separate ringer (buzzer)
- Speaker volume control (double-button, marked with '+' and '-', for volume up and down)
- Built-in off-hook detection circuit

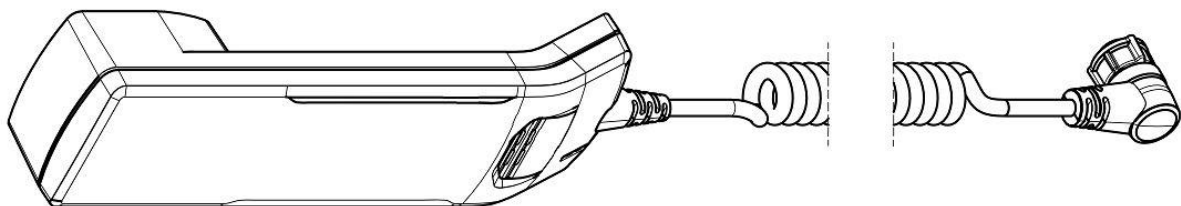

Figure 7: LT-3121 Handset (back view)

**NOTE:** The LT-3110S Control Unit will inform the user if the LT-3120 handset is not properly connected to the LT-3110S Control Unit. A BAM alert will be activated (Lost handset).

**NOTE:** The LT-3120 Handset must be operated together with the LT-3121 Cradle, for the off-hook detection circuit to work. The LT-3121 Cradle is described in *LT-3121 Cradle* on page 11.

### LT-3121 Cradle

The LT-3121 Cradle is used together with the LT-3120 Handset. The LT-3121 Cradle should be mounted next to the LT-3110S Control Unit, supporting the LT-3120 Handset. The LT-3121 Cradle specifications are available in *App. H - Specifications* on page 202.

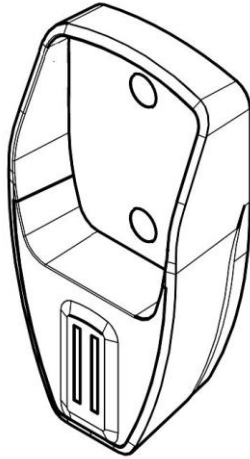

Figure 9: LT-3121 Cradle (front view)

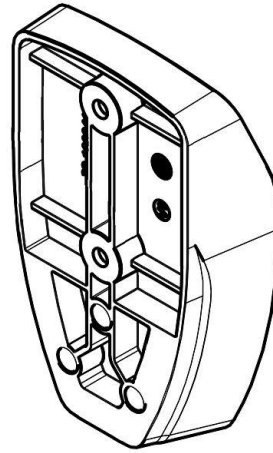

Figure 8: LT-3121 Cradle (back view)

**IMPORTANT:** The LT-3121 Cradle contains a magnet, to hold on to the LT-3120 Handset. Make sure that other electronic equipment is installed in a distance respecting the compass safe distance of 1.0 m (3.3 ft).

An outline drawing for the LT-3121 Cradle is available in *App. S - Outline Drawing: LT-3121 Cradle* on page 214.

### LT-3130 Antenna Unit

The LT-3130 Antenna Unit is designed for outdoor mounting and connected to the LT-3110S Control Unit via a coaxial cable. The LT-3130 Antenna Unit specifications are available in *App. H - Specifications* on page 202. The LT-3130 Antenna Unit has an N connector (female) mounted, centered at the bottom of the antenna.

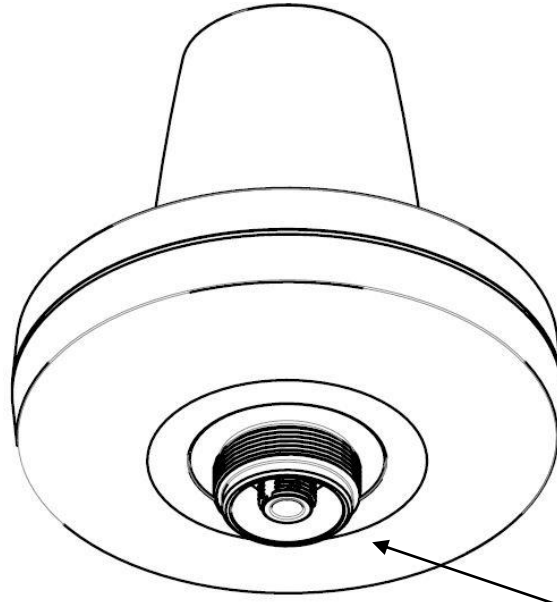

Figure 10: LT-3130 Antenna Unit

The LT-3130 Antenna Unit has an N connector (female) at the bottom side of the unit.

#### Mounting and installation considerations:

- Mount the unit vertically (with the N connector pointing down)
- Mount the unit with free line of sight to the Iridium® and GNSS satellites. Make sure that the unit can receive signals from the Iridium® and GNSS satellites (satellite reception information is available in the LT-3110S Control Unit user interface display, see Figure 46 on page 48)
- Mount the unit on a rigid structure with a minimum of exposure to vibration and shock
- Mount the unit using either the Bracket Mount or Pole Mount provided by Lars Thrane A/S
- Mount the unit outdoor with an ambient temperature between -40°C to +55°C (-40°F to +131°F)
- Mount the unit with a minimum angle of 20 degrees towards a radar antenna (above or below) and keep a minimum distance of 2.5 m (8 ft)
- Mount the unit at least 1 m. (3 ft.) away from radio transmitting antennas (VHF, UHF, MF-HF)
- Mount the unit away from Inmarsat and transmitting VSAT antennas

**NOTE:** It is only the LT-3130 Antenna Unit marked with HVIN 2.00 (Unit Label) or newer that can be used for the LT-3100S GMDSS Satellite Communications System. The LT-3100S GMDSS software will check the antenna unit during power up and the system will not be operational, if connecting a legacy LT-3130 Antenna Unit.

In order to avoid breaking the LT-3130 Antenna Unit N connector (female), it is important not to use tooling when connecting and fastening the coaxial cable N connector (male) to the antenna unit. The coaxial cable N connector thread nut must be fastened by hand only.



Figure 11: Connecting the coaxial cable N connector to the LT-3130 Antenna Unit

**IMPORTANT:** Maximum allowed torque is 2 Nm when connecting the coaxial cable N connector (male) to the N connector (female) of the LT-3130 Antenna Unit. No tooling must be used for fastening the coaxial cable thread nut as illustrated on Figure 11 above.

The LT-3130 Antenna Unit has a hazard warning label attached to the radome as illustrated in Figure 12.

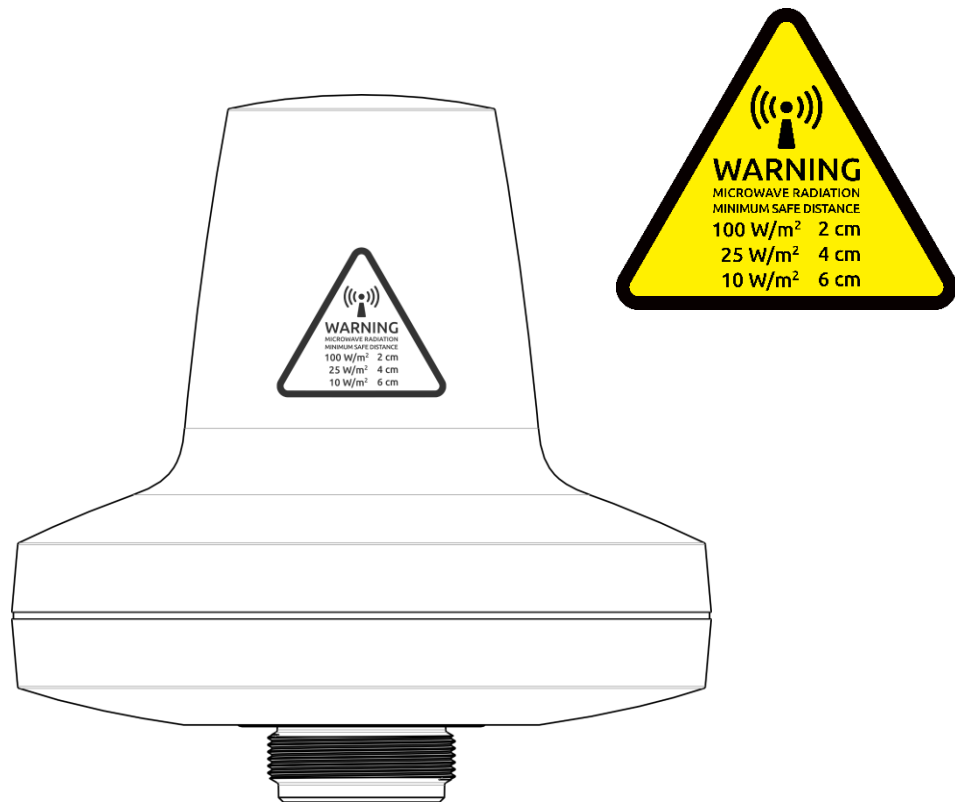

Figure 12: LT-3130 Antenna Unit (incl. warning label)

**WARNING:** The safety distance from the LT-3130 Antenna Unit, is 0.1 m (0.3 ft), in order to comply with the regional regulations.

**IMPORTANT:** Due to the adjacency of the Iridium and Inmarsat frequency bands, the LT-3130 Antenna Unit may not co-operate in the proximity of an active Inmarsat antenna unit, see *Coexisting with Inmarsat L-band* on page 19.

The LT-3130 Antenna Unit must be installed outside the main beam of the radar. Typically, this is in the order of 20 degrees. To avoid near field antenna coupling, a minimum distance of 2.5 m (6 ft) between the radar antenna and the LT-3130 Antenna Unit must be obeyed. Figure 13 is illustrating how the LT-3130 Antenna Unit should be mounted to avoid interference from radars.

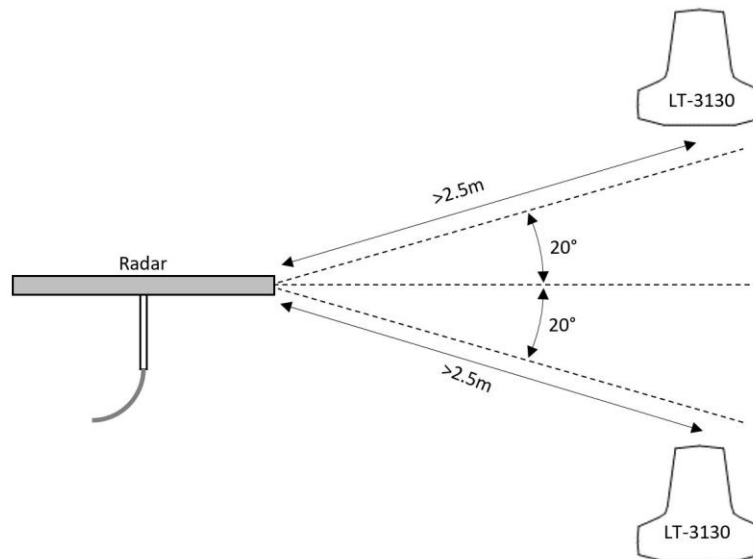

Figure 13: LT-3130 Antenna Unit (avoid the radar beam)

**IMPORTANT:** Failing to obey the specified installation conditions will void the warranty. However, depending on the specific radar frequency and power level, the separation distance between the radar and the LT-3130 Antenna Unit may be reduced, with no impact on the antenna performance. The performance of the LT-3130 Antenna Unit should be validated after the LT-3100S GMDSS system is installed.



The LT-3130 Antenna Unit must be mounted minimum 1 m from MF-HF, VHF, and UHF antennas.

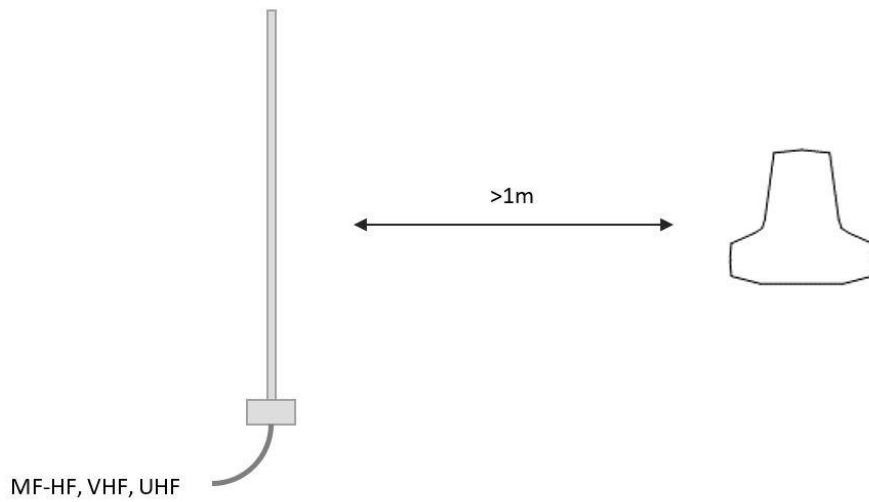

Figure 14: LT-3130 Antenna Unit (separation to MF-HF, VHF, and UHF antennas)

**NOTE:** The LT-3130 Antenna Unit must be installed with a 360° clear view of the sky. However, minor obstructions such as a mast will not degrade the antenna performance severely if a separation distance is kept larger than 15 times the diameter of the obstruction.

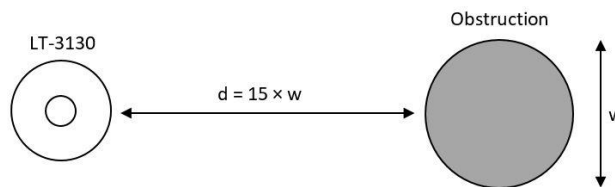

Figure 15: LT-3130 Antenna Unit (separation distance to minor obstructions)

The LT-3130 Antenna Unit must be mounted using one of the mounts listed in *Mounts* on page 4

The LT-3130 Antenna Unit must be mounted with free line of sight to the Iridium satellites for best possible performance. The best location will typically be at the top of the lantern mast, where there are no obstructions blocking the Iridium satellite link. The LT-3130 Antenna Unit is designed to maintain a communication link to the Iridium satellites in all weather conditions, see Table 2.

Extreme Ship Motion Values & Clear View Angles Below the Horizontal Plan			
Motion Direction	Maximum Amplitude	Iridium Satellite Acq.	Clear View Angle Below the Horizontal Plan
Roll	±30°	+8°	-22°
Pitch	±10°	+8°	-2°

Table 2: LT-3130 AU Roll and Pitch Clear View Angles (below the horizontal plan)

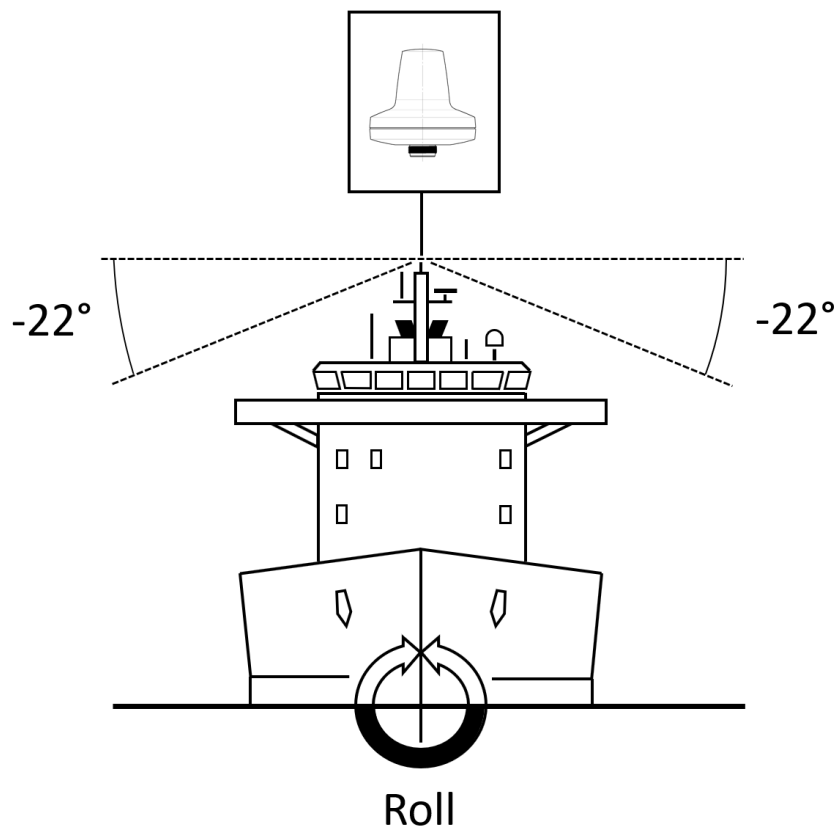

Figure 16: LT-3130 AU Installation (roll: clear view angle below the horizontal plan)

**NOTE:** The LT-3130 Antenna Unit must be mounted with a -22° clear view angle below the horizontal plan (port and starboard directions), where no obstructions must block the Iridium satellite signal, to maintain full functionality under extreme roll conditions. Also, the upper hemisphere must also be without any blockages to the Iridium satellites.

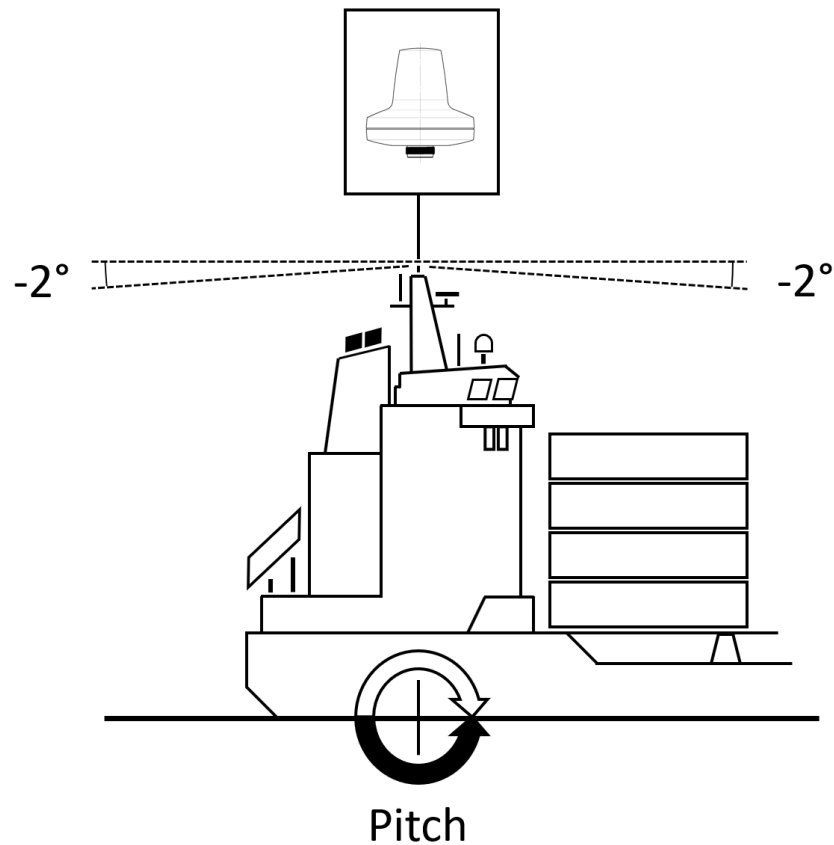

Figure 17: LT-3130 AU Installation (pitch: clear view angle below the horizontal plan)

**NOTE:** The LT-3130 Antenna Unit must be mounted with a  $-2^\circ$  clear view angle below the horizontal plan (fore and after directions), where no obstructions must block the Iridium satellite signal, to maintain full functionality under extreme pitch conditions. Also, the upper hemisphere must be without any blockages to the Iridium satellites.

**IMPORTANT:** For best possible performance of the LT-3100S GMDSS system, the LT-3130 Antenna Unit must have free line of sight to the Iridium satellites as illustrated in Figure 16 and in Figure 17 (clear view angle below the horizontal plan). In order to have the best possible performance, also in an emergency situation, obstructions should be below the marked lines of these two illustrative figures.

**Coexisting with Inmarsat L-band**

It is possible to install the LT-3100S GMDSS system onboard a vessel that already has Inmarsat C equipment installed.

It is important to note that the LT-3130 Antenna Unit must be mounted below the Inmarsat C antenna with a minimum distance of 1 m and below an angle of minimum 15° when coexistence is required.

Practical use of the LT-3100S GMDSS system during Alpha and Beta Sea trials, installed onboard vessels with Inmarsat equipment, has not revealed any degradation in system performance.

The LT-3100S GMDSS system will continuously try to deliver the Iridium GMDSS Safety Services e.g., Distress Alert and Safety Messaging in a situation where the LT-3100S GMDSS system may experience degradation or loss of satellite signal. Whenever the satellite signal is back again, the terminal will resume and finalize the requested Safety Service to provide the highest level of safety for the crew.

**Survival distances:**

Mount the LT-3130 Antenna Unit at a minimum distance of 1 m from an Inmarsat C antenna.

Mount the LT-3130 Antenna Unit at a minimum distance of 3 m from an Inmarsat Fleet Broadband antenna.

### LT-3140S Interface Unit

The LT-3140S Interface Unit is designed for indoor mounting and is connected directly to the LT-3110S Control Unit via an Ethernet cable. The LT-3140S Interface Unit specifications are available in *App. H - Specifications* on page 202.

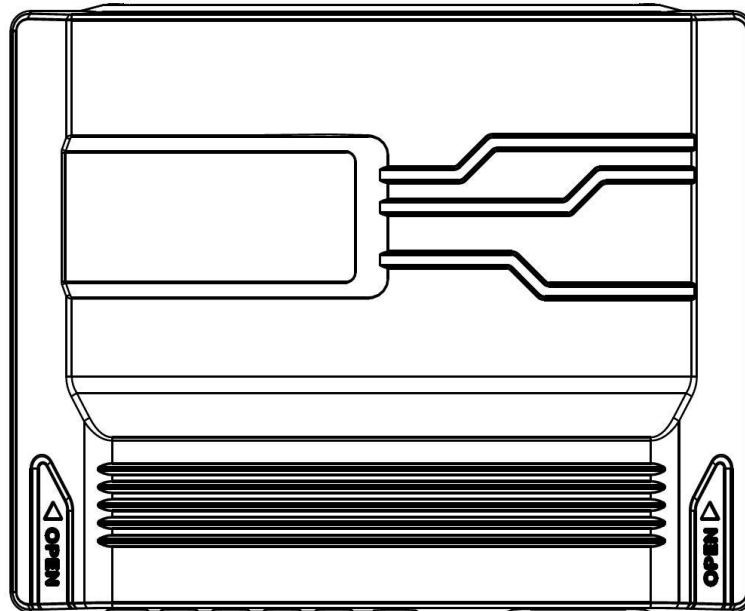

Figure 18: LT-3140S Interface Unit (with front cover).

The LT-3140S Interface Unit without front cover is illustrated in Figure 39 on page 39.

The LT-3140S Interface Unit front cover can be removed by pushing on both sides of the front cover, marked with the text 'Open' and press the front cover upwards (hold tight to the backplate, if the unit is not mounted).

Once, the LT-3140S Interface Unit front cover has been removed, the LT-3140S Interface Unit can be flush mounted on a surface. Use all four screw holes (every corner) of the backplate, to fasten the unit sufficiently.

The LT-3140S Interface Unit interfaces are described in *LT-3140S Interface Unit* on page 39.

**LT-3150S Alarm Panel**

The LT-3150S Alarm Panel is designed for indoor mounting and connected to the LT-3140S Interface Unit via a proprietary 4-wire CAN cable. The LT-3150S Alarm Panel specifications are available in *App. H - Specifications* on page 202.

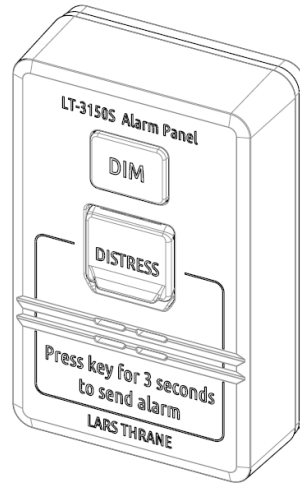

Figure 19: LT-3150S Alarm Panel

The LT-3150S Alarm Panel consist of the following human interface functions: DISTRESS button, DIM button, and speaker. The LT-3150S Alarm Panel is delivered with a 25m cable attached to the unit.

The wire designation of the LT-3150S Alarm Panel is described in Table 3. The LT-3150S Alarm Panel can only be connected to the LT-3140S Interface Unit.

LT-3150S AP Interconnect Details	
Wire Color	Wire Designation
White	VCC
Yellow	CAN+
Green	CAN-
Brown	GND

Table 3: LT-3150S Alarm Panel (interconnect details)

**IMPORTANT:** See *Distress Alert & Distress Call* on page 71 for operation of the DISTRESS button and activation of Distress Alert and Distress Call.

The LT-3150S Alarm Panel must be flush mounted. A flush mount is delivered together with the LT-3150S Alarm Panel. The LT-3150S Alarm Panel with the flush mount is illustrated in Figure 20.

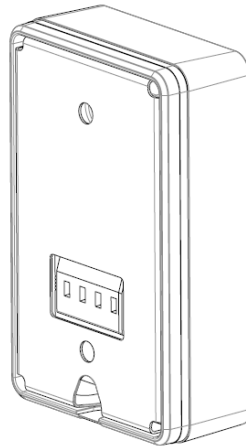

Figure 20: LT-3150S Alarm Panel (back view)

The LT-3150S Alarm Panel can be released from the flush mount by using a release tool as illustrated in Figure 22 and Figure 21.

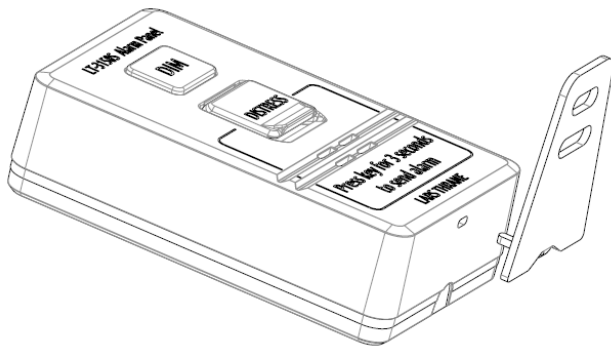

Figure 22: LT-3150S Alarm Panel (release tool)

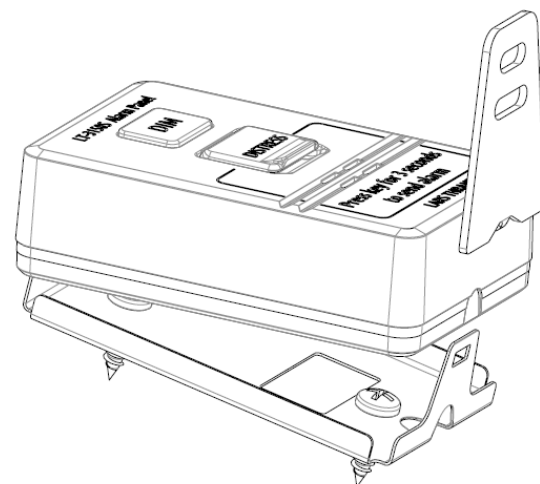

Figure 21: LT-3150S Alarm Panel (release tool)

**LT-3160S Printer Adapter**

The LT-3160S Printer Adapter is designed for indoor mounting and connected to the LT-3140S Interface Unit via a proprietary 4-wire CAN cable. The LT-3160S Printer Adapter specifications are available in *App. H - Specifications* on page 202.

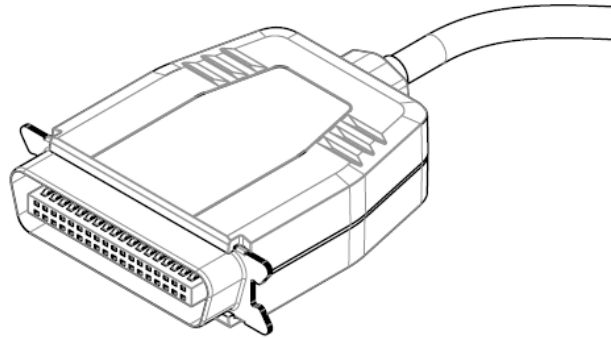

Figure 23: LT-3160S Printer Adapter

The LT-3160S Printer Adapter is interfacing to a GMDSS printer, using the Centronics interface, 36 pins (IEEE Std 1284-2000, 1284-B receptacle connector). The LT-3160S Printer Adapter is delivered with a 25m cable attached to the unit.

The wire designation of the LT-3160S Printer Adapter is described in Table 4. The LT-3160S Printer Adapter can only be connected to the LT-3140S Interface Unit.

LT-3160S PA Interconnect Details	
Wire Color	Wire Designation
White	VCC
Yellow	CAN+
Green	CAN-
Brown	GND

Table 4: LT-3160S Printer Adapter (interconnect details)

The list of GMDSS printers supported and tested are available in *GMDSS Printers* on page 155.



### Bracket Mount, Antenna Unit

The Bracket Mount (1.5" to 2.5" pipe), Antenna Unit installation options are illustrated in Figure 24 to Figure 29.

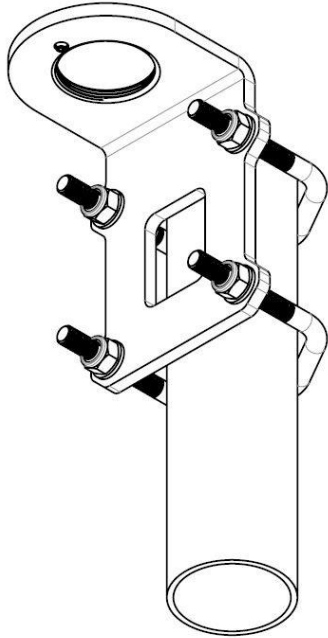

Figure 24: Bracket Mount (1.5" to 2.5" pipe), Antenna Unit (vertical pipe mount)

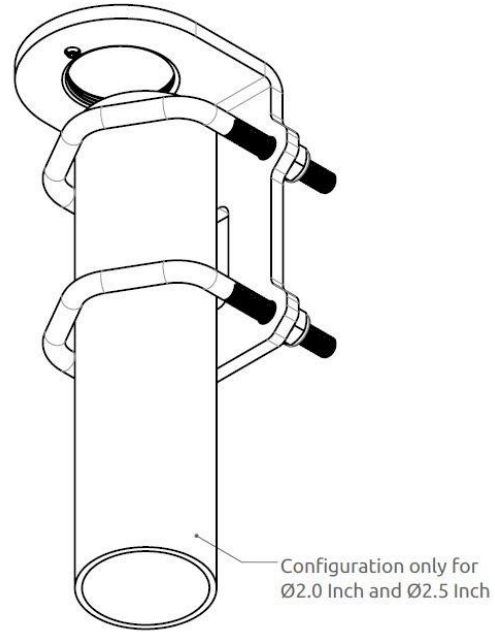

Figure 25: Bracket Mount (1.5" to 2.5" pipe), Antenna Unit (vertical pipe mount)

#### Bracket mount installation procedure:

1. Fasten the bracket mount to a pipe (max. 2.5" pipe) by using the two V-bolts and the M8 prevailing nuts, as illustrated in Figure 27 on page 25 (max torque = 5.5 Nm)
2. Screw on the LT-3130 Antenna Unit and secure the antenna lock pinot (max torque = 1.2 Nm)
3. Fasten the coaxial cable to the LT-3130 Antenna Unit (N connector)
4. Apply self-volcanic tape on the N connector and cable to protect against saltwater and corrosion or use the recommend Cable Hose

**NOTE:** Always fasten the Bracket Mount, Antenna Unit (1.5" to 2.5" pipe) to the pipe, before installing the LT-3130 Antenna Unit (the antenna unit and bracket mount are fastened together by the thread lock). Remember to secure the pinot screw after the antenna unit has been fastened. The torques are specified in Figure 27 on page 25.

**NOTE:** The Bracket Mount (1.5" to 2.5" pipe), Antenna Unit interfaces to a pipe of maximum 2.5" (63.5 mm), measured outer diameter.

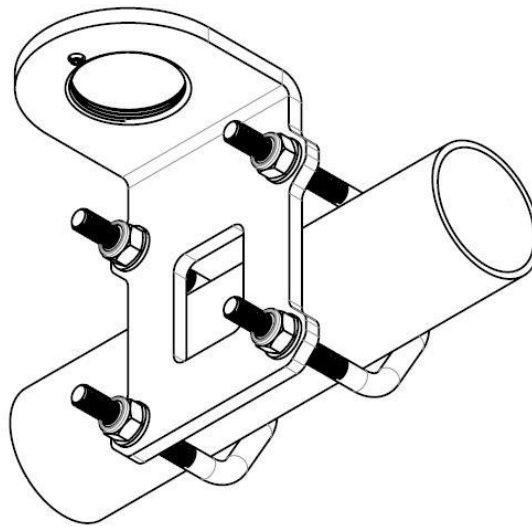

Figure 26: Bracket Mount (1.5" to 2.5" pipe),  
Antenna Unit (horizontal pipe mount)

The Bracket Mount (1.5" to 2.5" pipe), Antenna Unit can support tubes in the interval 1.5" to 2.5". The torques are specified in Figure 27. The bracket mount, V-bolts, and nuts are all made of A4 stainless steel.

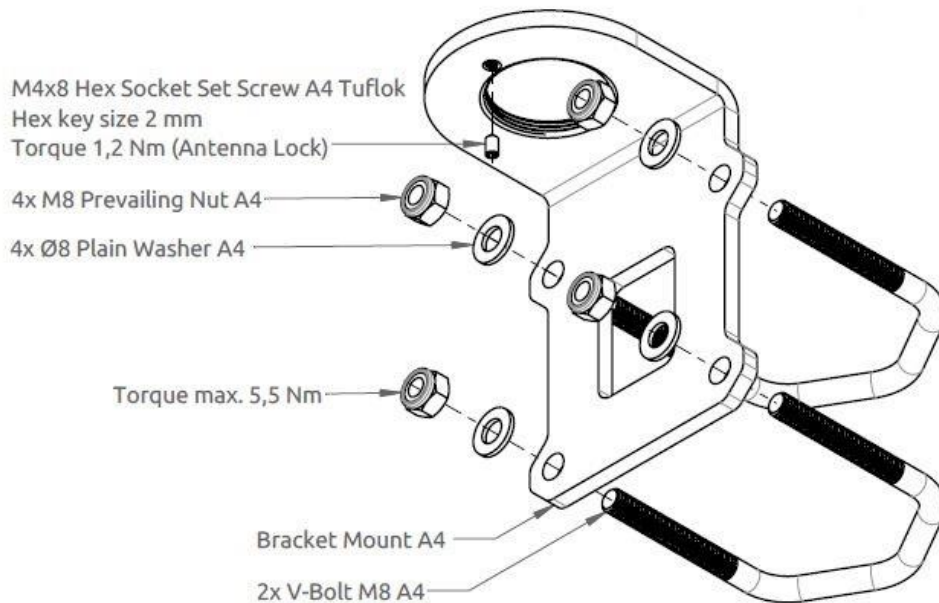

Figure 27: Bracket Mount (1.5" to 2.5" pipe), Antenna Unit (horizontal pipe mount)

To avoid corrosion issues when using the Bracket Mount (1.5" to 2.5" pipe), Antenna Unit - it is recommended to use the cable hose as illustrated in Figure 28 and in Figure 29. The cable hose consists of a UV resistant silicone tube and an aluminum anodized thread block, which can be fastened to the LT-3130 Antenna Unit providing protection to the coaxial cable N connector and surroundings.

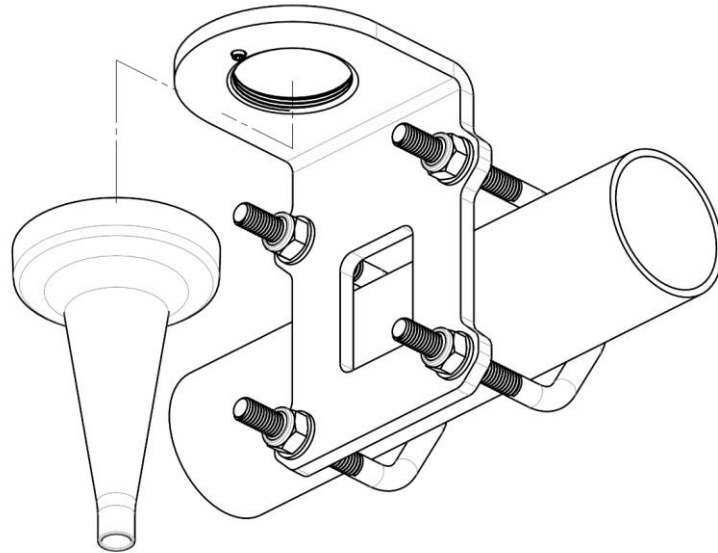

Figure 28: Bracket Mount (1.5" to 2.5" pipe), Antenna Unit with Hose

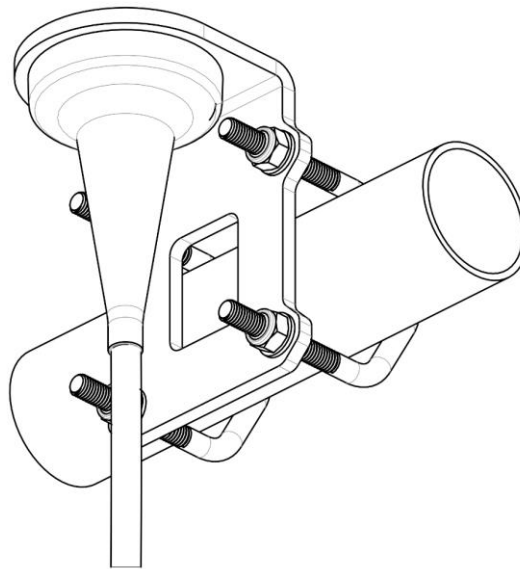
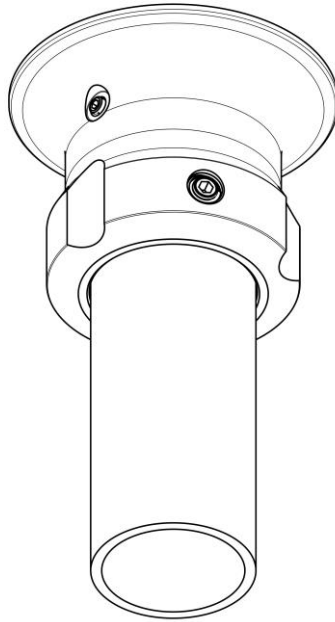

Figure 29: Bracket Mount (1.5" to 2.5" pipe), Antenna Unit with Hose

**NOTE:** The cable hose will be included in the new ordering number for the Bracket Mount (1.5" to 2.5" pipe), Antenna Unit. The cable hose can also be ordered separately. See *Mounts* on page 4 for more details on the ordering numbers regarding the cable hose.

### Pole Mount, Antenna Unit

The Pole Mount (1.5" pipe), Antenna Unit is illustrated in Figure 30 to Figure 32.



*Figure 30: Pole Mount (1.5" pipe),  
Antenna Unit*

#### Pole mount installation procedure:

1. Feed the coaxial cable through the pole mount
2. Fasten the coaxial cable to the LT-3130 Antenna Unit (N connector)
3. Apply self-vulcanic tape on the N connector and cable to protect against saltwater and corrosion
4. Screw the pole mount (clockwise) on the LT-3130 Antenna Unit, and fasten the antenna lock pinot screw, as illustrated in Figure 32 (max torque = 1.2 Nm)
5. The LT-3130 Antenna Unit and pole mount can now be mounted on the 1.5" pipe. Fasten the three pole lock pinot screws, as illustrated in Figure 31 (max torque = 4.5 Nm)

**NOTE:** Remember to fasten the antenna lock pinot screw (1.2 Nm) after the pole mount and antenna unit have been screwed together.

**NOTE:** The Pole Mount (1.5" pipe), Antenna Unit interfaces to a tube of maximum 1.5" (38.1 mm), measured outer diameter.

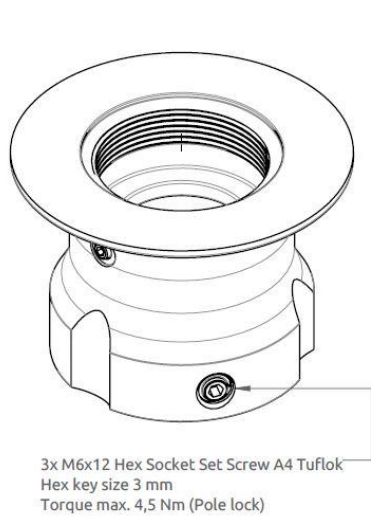

Figure 31: Pole Mount (1.5" pipe), Antenna Unit

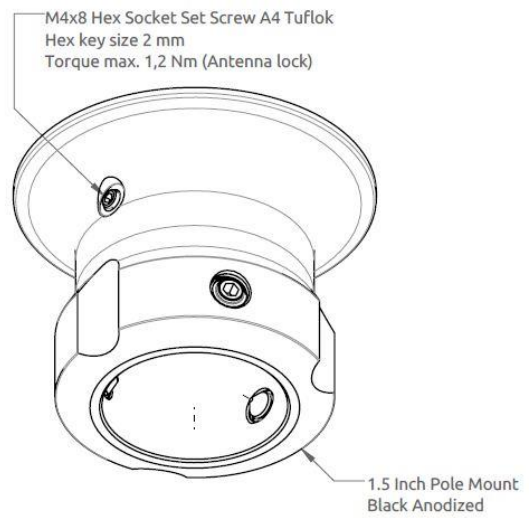

Figure 32: Pole Mount (1.5" pipe), Antenna Unit

**NOTE:** The Pole Mount (1.5" pipe), Antenna Unit only support a 1.5" pipe. The pinot screws (antenna and pole lock) torques are specified in Figure 31 and Figure 32. The pole mount is made of milled aluminum (anodized). The pinot screws are made of A4 stainless steel.

## Interfaces

### LT-3110S Control Unit

This section will describe all the external interfaces from the LT-3110S Control Unit.

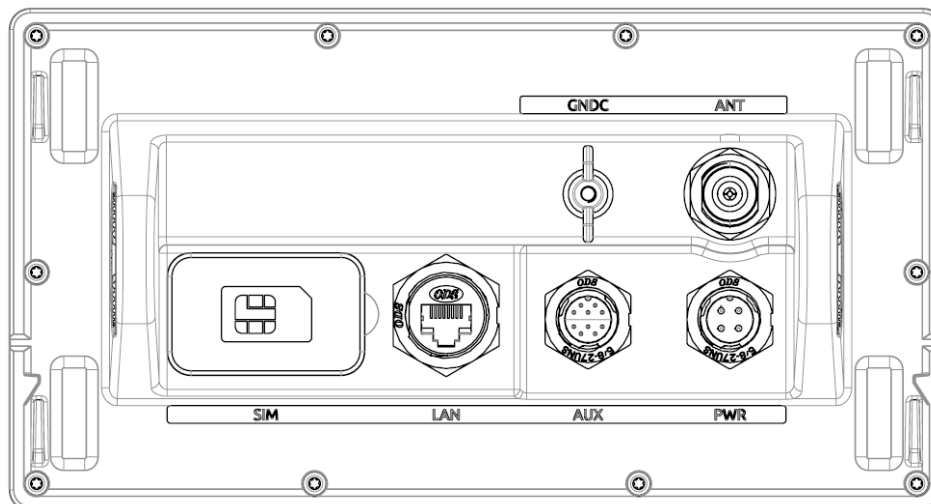

Figure 33: LT-3110S Control Unit (back view)

#### DC input (PWR)

The LT-3100S GMDSS system is designed to be used on 12 VDC and 24 VDC power buses (nominal). External DC power to the LT-3100S GMDSS system is provided by connecting the proprietary 91-102118 Power Cable, 3m - delivered by Lars Thrane A/S. The power connector is mounted on the back side of the LT-3110S Control Unit and marked 'PWR', see Figure 33.

The power source for the LT-3100S GMDSS System must comply with the GMDSS regulations and the associated standards, minimum is compliance to IEC 60945 (2002). The power source to LT-3110S Control Unit and the LT-3140S Interface Unit must be connected to the main and emergency source of power as required by SOLAS reg II-1/42 or /43, and a battery backup system. When extending the power supply cables the positive (+) and the negative (-) must be installed closely together in order to keep the cable inductance low.

**NOTE:** The input voltage range is: 12-24 VDC (2.2-1.7A). The LT-3110S Control Unit DC input connector and circuit is protected and certified for reverse polarity protection.

**NOTE:** The LT-3130 Antenna Unit operational low temperature is:  
 -30°C (-22°F) when using 12 VDC input power on the LT-3110S Control Unit  
 -40°C (-40°F) when using 24 VDC input power on the LT-3110S Control Unit

**NOTE:** The DC input power source must be connected to a battery backup system (requirement for all SOLAS vessels). The power source and battery backup system are not provided by Lars Thrane A/S.

**NOTE:** It may be noted that for vessels without an emergency source of power it may be possible to install the LT-3100S GMDSS system, if the capacity of the reserve source (battery backup) is at least 6 hours.

**NOTE:** A new power connector (4-pole) has been introduced with the LT-3110S Control Unit. This new power connector requires the new 91-102118 power cable, 3m from Lars Thrane A/S. Use only the 91-102118 power cable, 3m delivered by Lars Thrane A/S.

### **Chassis ground (GNDC)**

The chassis ground connector is placed on the back side of the LT-3110S Control Unit and marked with 'GNDC', see Figure 33 on page 29.

**GMDSS SIM card (SIM)**

The LT-3100S GMDSS system requires a GMDSS SIM card to be operated with the Iridium® satellite services. The Iridium® GMDSS SIM card must be bought from one of the official Iridium® GMDSS Service Providers. A list of Iridium® GMDSS Service Providers can be found at the Iridium® website: <https://www.iridium.com> (select 'Services', and hereafter 'Iridium GMDSS').

The GMDSS SIM card must be inserted in the LT-3110S Control Unit behind the rubber dust cover. Make sure that the LT-3110S Control Unit is powered off before opening the rubber dust cover. When the GMDSS SIM card is properly inserted in the slot, and the rubber dust cover is secured, the LT-3110S Control Unit can be powered up. The rubber dust cover is illustrated in Figure 33 on page 29 and marked with 'SIM'.

The following procedure must be followed when inserting, replacing, or removing the GMDSS SIM card:

1. Turn off the power to the LT-3110S Control Unit
2. Remove the rubber dust cover on the back side of the LT-3110S Control Unit
3. Slide the SIM card holder as illustrated with the arrows on the PCB print, to unlock
4. Open the SIM card holder and insert or remove the SIM card
5. Close the SIM card holder
6. Slide the SIM card holder as illustrated with the arrows on the PCB (opposite direction), to lock
7. Re-insert the rubber dust cover
8. Turn on power to the LT-3110S Control Unit

**NOTE:** The LT-3110S Control Unit must be powered off when inserting, changing, or removing the GMDSS SIM card. The GMDSS SIM card is hidden behind the rubber dust cover on the back side of the LT-3110S Control Unit.

Figure 34 is illustrating an Iridium GMDSS SIM card. The format is Mini-SIM (2FF) 25 x 15 mm. The GMDSS SIM card must be removed from the full-sized card carrier by breaking the Mini-SIM out. The full-sized card carrier contains the MSISDN number, while the SIM card itself contains the ICCID.

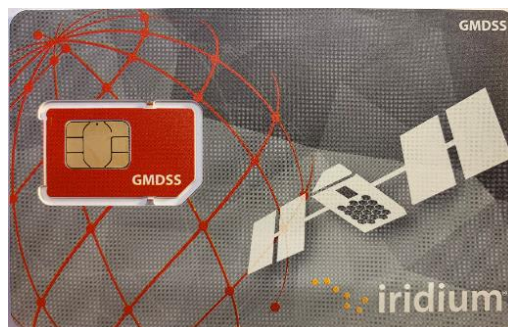

Figure 34: Iridium GMDSS SIM card



The GMDSS SIM card will be delivered from the Iridium GMDSS Service Providers (SP) together with the essential information:

- MSISDN number (the Iridium Mobile Subscriber ISDN number)
- ICCID

**IMPORTANT:** During activation of the GMDSS SIM Card, the Iridium GMDSS Service Provider will request vessel details (Vessel name, IMO number, MMSI number, etc.). This essential data must be delivered correctly to the Iridium GMDSS Service Provider and will be validated upon completing the Installation Wizard. If any of the data is not correct, then the Iridium GMDSS Service Provider must be contacted and data must be corrected, before finalizing the GMDSS installation and activation.

The GMDSS SIM card will be delivered with the SIM lock feature disabled. Thus, the LT-3100S GMDSS system will be operational as soon as the GMDSS SIM card is inserted, and the Installation Wizard has been completed. The activation of the LT-3100S GMDSS system, hereunder the Installation Wizard, is described in further details in *Activating the System* on page 54.

**NOTE:** The GMDSS SIM card will be delivered with the SIM lock feature disabled. It is not possible to activate the SIM lock, since it always must be possible to use the system as the primary safety communication system.

#### **Ethernet RJ45 (LAN)**

The LT-3110S Control Unit has an Ethernet LAN (RJ-45) interface, supporting service & maintenance or connection to the LT-3140S Interface Unit. The Ethernet interface can be used to access the built-in web server, which is further described in *Web server* on page 156.

The LT-3110S Control Unit will automatically request and obtain an IP address when connected to a Local Area Network (LAN) with a DHCP server (e.g. a router). If connecting the LT-3110S Control Unit directly to a PC, then the two will automatically negotiate an IPv4 Link-Local address. The current IP address can be found in the user interface display (Menu -> System -> Network: IP Address).

**NOTE:** LT-3100 GMDSS system is permitted to be connected to an IEC 61162 Ethernet network.

**Auxiliary (AUX)**

The auxiliary connector is a 10-pin connector (male) mounted on the backside of the LT-3110S Control Unit as illustrated in Figure 33 on page 29 and marked with 'AUX'. The auxiliary connector contains the following interfaces:

- RS-422 serial interface
- 2 x External (I/O)

The auxiliary connector pin out and auxiliary cable wire color and designation are illustrated in Figure 36, Figure 35, and in Table 5.



Figure 36: AUX connector (pin out)



Figure 35: AUX cable (pin out)

Auxiliary (AUX) Cable		
Pin No.	Wire Color	Wire Designation
1	Black	External Output
2	Brown	External Output
3	Red	RS-422 Z (output) Tx-
4	Orange	RS-422 Y (output) Tx+
5	Yellow	RS-422 A (input) Rx+
6	Green	RS-422 B (input) Rx-
7	Blue	External Input
8	Violet	External Input
9	Gray	Not Used
10	White	RS422 (C) common

Table 5: AUX cable (wire color designation)

**NOTE:** Use only the 91-100768 Auxiliary Cable, 3m delivered by Lars Thrane A/S for connecting to the auxiliary connector on the backside of the LT-3110S Control Unit. The Auxiliary Cable, 3m is an accessory part and must be ordered separately.

The LT-3110S Control Unit is supporting external ringer functionality on the Auxiliary (External I/O) interface, which can be configured from the web server, see *External I/O* on page 170.

The LT-3110S Control Unit is supporting GNSS, BAM, and MSI data on the Auxiliary (RS-422) interface, which can be configured from the web server, see *GNSS, BAM and MSI* on page 171.

External Output and Input are further described on the next pages.

RS-422 Circuit Diagram (LT-3110S CU - Aux connector)

Figure 37 shows the RSS-422 circuit diagram used for the LT-3110S Control Unit (Aux connector).

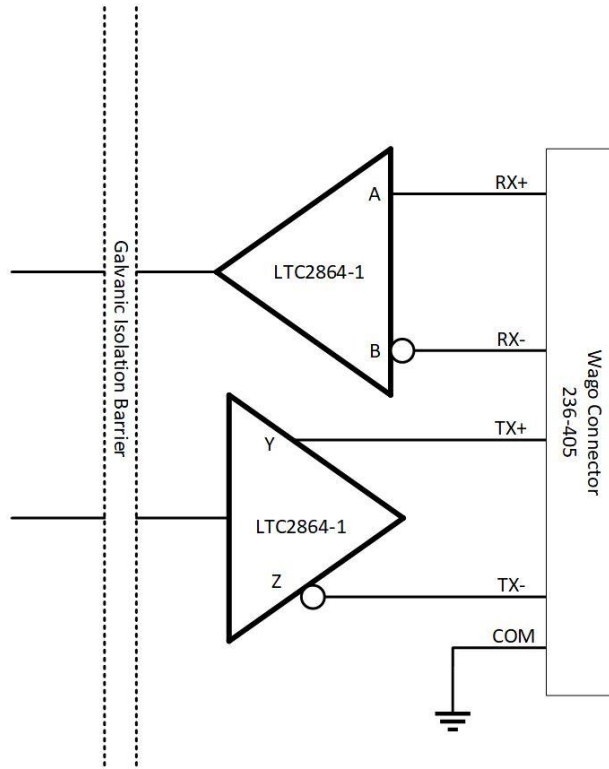

Figure 37: RS-422 Circuit Diagram for the LT-3110S CU

Interface Drive Capability as a Talker and Listener:

- A (Rx+), B (Rx-), Y (Tx+), Z (Tx-): -60V to +60V
- Short circuit protected
- Galvanic isolated up to 1500V

### External Output (External Ringer)

The LT-3100S GMDSS system support connection of an external speaker for incoming call notifications. Connection of the external speaker must be completed as illustrated in Figure 38, incl. a relay. The maximum voltage and current for the relay are documented on the figure. External Output (Pin 2) and External Output (Pin 1) designation and wire colors are listed in Table 5 on page 33.

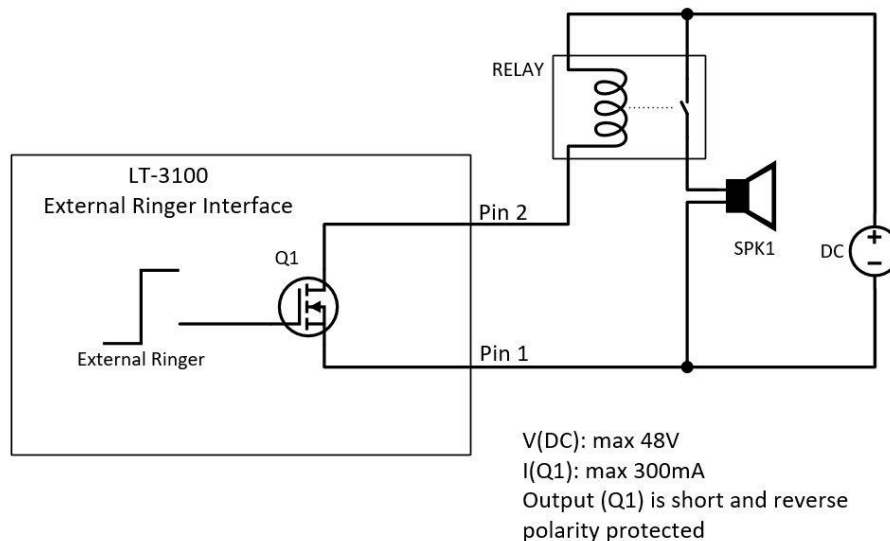

Figure 38: External I/O (external ringer diagram)

**NOTE:** The External Ringer functionality must be configured using the web server, Configuration - External I/O, see *External I/O* on page 170.

### External Input

The LT-3100S GMDSS system is not supporting any functionality for the External I/O Input.

### RS-422 (GNSS, BAM, and MSI)

The LT-3100S GMDSS system Auxiliary RS-422 (bi-directional) interface can be configured to support different functions. The following functions are supported:

- GNSS (see *GNSS sentences* on page 152)
- BAM (see *BAM sentences* on page 153)
- MSI (see *MSI sentences* on page 154)

The RS-422 interface can be configured using the web server, see *GNSS, BAM and MSI* on page 171.

**N Connector (ANT)**

The LT-3110S Control Unit has a N Connector (male) connector for the interface to the LT-3130 Antenna Unit. The N connector interface is providing data communication and power to the antenna unit over a coaxial cable. The N connector marked with 'ANT' is illustrated in Figure 33 on page 29.

**NOTE:** Do not connect or disconnect the antenna cable when the LT-3110S Control Unit is powered.

### LT-3130 Antenna Unit

The LT-3110S Control Unit and the LT-3130 Antenna Unit must be connected using a coaxial cable. Both the control unit and the antenna unit have a N connector (female) mounted. This section will specify the requirements to the coaxial cable. The RF and DC requirements are specified in Table 6 and Table 7.

RF Coaxial Cable Requirements	
Requirement	Specification
Cable impedance	50 $\Omega$
Maximum signal loss	45 dB/100 m @ 1.5 GHz

Table 6: RF Coaxial Cable Requirements

In most cases it will be the DC resistance that will determine the maximum length of the coaxial cable. It is important to note that the input voltage of the control unit is important for the length of the coaxial cable that can be used.

DC Coaxial Cable Requirements	
Power Source	Maximum DC Resistance
12 VDC	1.7 $\Omega$
24 VDC	5.5 $\Omega$

Table 7: DC Coaxial Cable Requirements

**NOTE:** The DC coaxial cable resistance that is listed in Table 7 and used to calculate the maximum cable length is the sum of the DC inner conductor resistance and the DC outer conductor resistance. Some data sheets are not providing enough information about the DC resistance, in which cases, the cable manufacture must be approached to obtain this information.

Lars Thrane A/S has calculated the maximum allowed cable lengths with two coaxial cables as illustrated in Table 8. The two coaxial cables are FF195LSFROH (~RG-58) and FF400LSFROH (~RG-214/LMR400).

Maximum Coaxial Cable Length		
Cable Type	12 VDC Supply	24 VDC Supply
FF195LSFROH (4.9mm)	41 m	135 m
FF400LSFROH (10.3mm)	154 m	500 m

Table 8: Maximum coaxial cable length (cable examples)

The cable lengths calculated in Table 8 are obtained by using the maximum DC resistance [ $\Omega$ ] from Table 7 and compare these maximum DC requirements with the actual DC resistance [ $\Omega$ /km] of the specific coaxial cables. The FF400LSFROH and FF195LSFROX total DC resistance numbers are listed in Table 9 on page 38.

The total DC resistance for the two cables (FF195LSFROH and FF400LSFROH) are:

Total DC Resistance (Inner and Outer Conductor)			
Cable Type	Inner Conductor DC Resistance [ $\Omega$ /km]	Outer Conductor DC Resistance [ $\Omega$ /km]	Total DC Resistance [ $\Omega$ /km]
FF195LSFROH (4.9 mm)	24.9	15.8	40.7
FF400LSFROH (10.3 mm)	4.5	6.5	11

*Table 9: Total DC resistance (cable examples)*

**IMPORTANT:** If using a coaxial cable that is different to what is specified in this section (FF195LSFROH and FF400LSFROH), then verify that the RF and DC coaxial cable requirements (Table 6 and Table 7) are respected and calculate the maximum cable length as a function of the input voltage and the total DC resistance. Contact Lars Thrane A/S to get assistance on selection and acceptance of a specific coaxial cable.

**NOTE:** The LT-3110S Control Unit must be powered off when connecting or disconnecting the LT-3130 Antenna Unit.

**LT-3140S Interface Unit**

The LT-3140S Interface Unit is designed for indoor mounting and connected to the LT-3110S Control Unit via an Ethernet cable. The LT-3140S Interface Unit specifications are available in *App. H - Specifications* on page 202. Cable strain relief must be used for securing all cables connected to the LT-3140S Interface Unit.

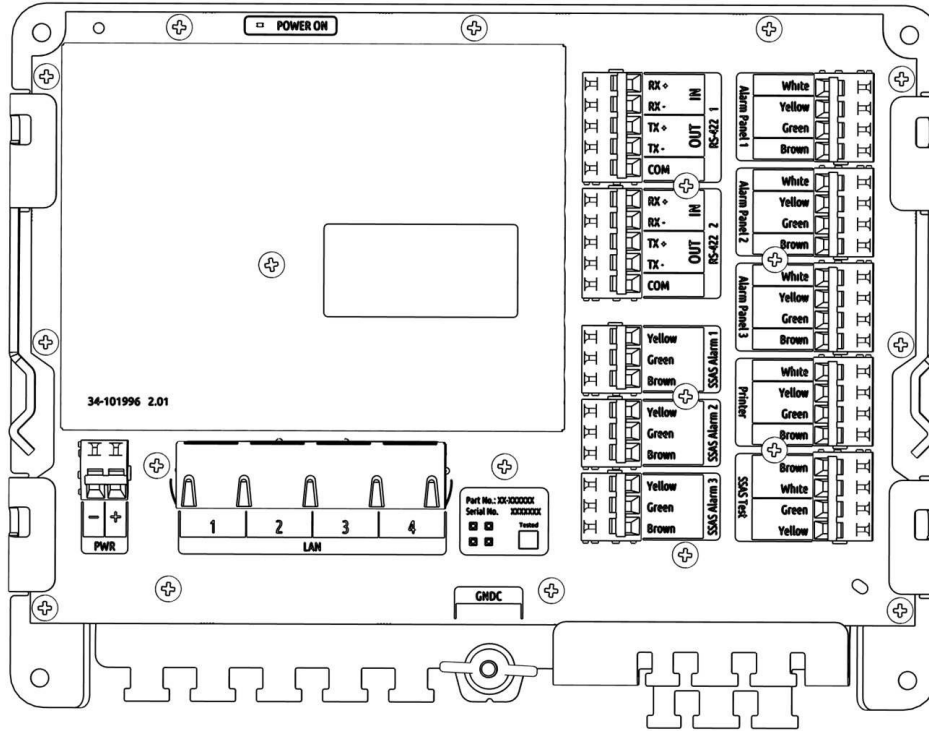

Figure 39: LT-3140S Interface Unit

The LT-3140S Interface Unit interfaces and number of interfaces are listed in Table 10.

LT-3140S Interface Unit		
Interface	Number of Interfaces	Name
Ethernet	4	LAN 1 to 4
RS-422	2	RS-422 1 and RS-422 2
GPIO	4	SSAS Alarm 1 to 3, and SSAS Test
CAN	4	Alarm Panel 1 to 3, and Printer Adapter
DC input	1	PWR (12 or 24 VDC input)
Chassis ground	1	GNDC (connect to vessel ground)

Table 10: LT-3140S Interface Unit

The LT-3140S Interface Unit must be used if connecting LT-3150S Alarm Panel, LT-3160S Printer Adapter, SSAS Alert button, or SSAS Test button. The two RS-422 bi-directional interfaces can be used for GNSS, BAM, and MSI, which is further described in *Serial Interface (RS-422)* on page 152 and the configuration in the *Web server* on page 156. The LT-3110S Control Unit also has a RS-422 interface to support these functions. The layout of the LT-3140S Interface Unit (incl. labels) is illustrated in Figure 40 on page 40. Interface name and wire color descriptions are available on all interfaces to make the connection easy.



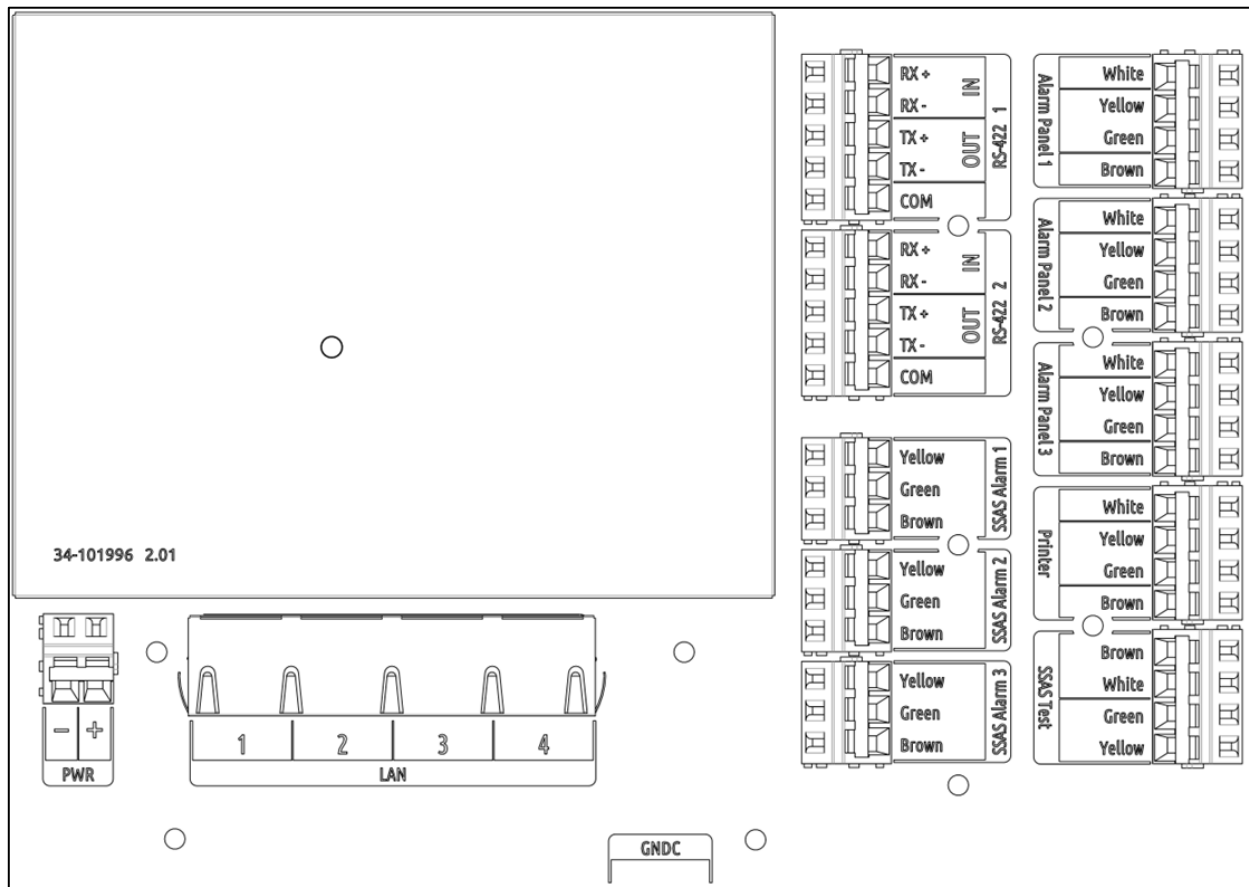

Figure 40: LT-3140S Interface Unit (with interface labels)

3 x spare Ethernet (LAN) interfaces are available on the LT-3140S Interface Unit to support future information protocols. It is possible to service the LT-3100S GMDSS system by connecting an external PC to one of these spare LAN ports (e.g. for software update of the system or downloading a diagnostic report).

**NOTE:** LT-3100 GMDSS system is permitted to be connected to an IEC 61162 Ethernet network.

**NOTE:** All RS-422 interfaces of both the LT-3110S Control Unit and LT-3140S Interface Unit are compliant with IEC 61162-1, IEC 61162-2 and IEC 61162-450. BAM can only be activated on a single RS-422 interface.

RS-422 Interface (LT-3140S IU - RS-422 1 and RS-422 2)

The RS-422 interfaces supported from the LT-3140S Interface Unit are shown in Table 12 and Table 11.

LT-3140S IU (RS-422 1)	
Pin Connector Name	Signal Designation
Rx+	RS-422 A (input)
Rx-	RS-422 B (input)
Tx+	RS-422 Y (output)
Tx-	RS-422 Z (output)
COM	RS-422 (C) common

Table 12: LT-3140S IU (RS-422 1)

LT-3140S IU (RS-422 2)	
Pin Connector Name	Signal Designation
Rx+	RS-422 A (input)
Rx-	RS-422 B (input)
Tx+	RS-422 Y (output)
Tx-	RS-422 Z (output)
COM	RS-422 (C) common

Table 11: LT-3140S IU (RS-422 2)

RS-422 Circuit Diagram (LT-3140S IU - RS-422 1 and RS-422 2)

Figure 41 shows the RSS-422 circuit diagram used for the LT-3140S Interface Unit (RS-422 1 and RS-422 2).

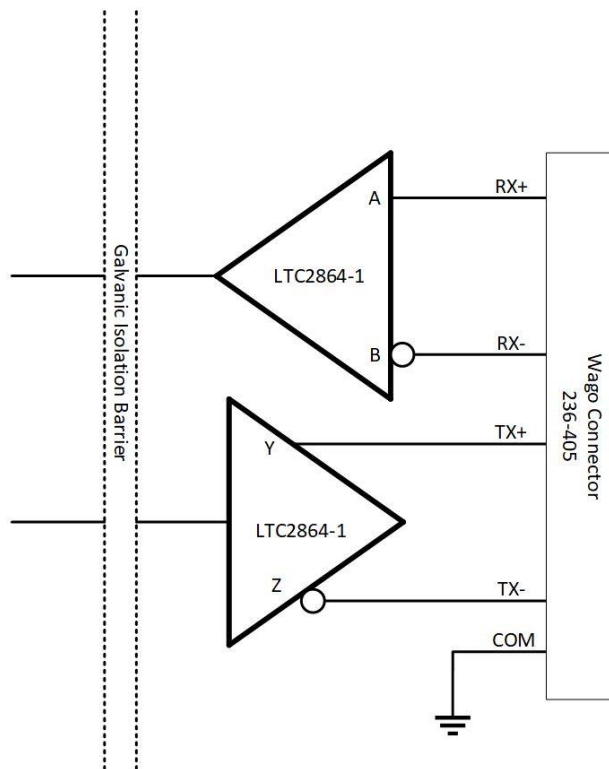

Figure 41: RS-422 Circuit Diagram for the LT-3140S IU

Interface Drive Capability as a Talker and Listener:

- A (Rx+), B (Rx-), Y (Tx+), Z (Tx-): -60V to +60V
- Short circuit protected
- Galvanic isolated up to 1500V

**DC input (PWR)**

The LT-3140S Interface Unit is designed to be used on 12 VDC and 24 VDC power buses (nominal). External DC power to the LT-3140S Interface Unit is provided by connecting a DC cable (plus/minus), incl. crimp tubes, to the DC input power connector. The power connector on the LT-3140S Interface Unit is marked with 'PWR'. All connectors on the LT-3140S Interface Unit is hidden below a front cover as illustrated in Figure 18 on page 20.

**NOTE:** The input voltage range is: 12-24 VDC (0.7-0.4A). The LT-3140S Interface Unit DC input connector and circuit is protected and certified for Reverse Polarity Protection.

**Chassis ground (GNDC)**

The chassis ground connector is placed underneath the front cover of the LT-3140S Interface Unit and marked with 'GNDC', see Figure 39 on page 39.

**IMPORTANT:** Only DC input power: 12 to 24 VDC must be applied on the LT-3140S Interface Unit. Crimp tubes on the DC power cable must be used.

## Power Consumption

The LT-3100S GMDSS system is powered from 12 VDC or 24 VDC power source. This section will provide power consumption details for maximum power consumption and typical average power consumption to be used for calculating the back-up battery capacity, which is a requirement for GMDSS equipment onboard SOLAS vessels.

### Maximum

The LT-3100S GMDSS system maximum power consumption is listed in Table 13 and in Table 14. The maximum power consumption is calculated with activity on all interfaces. The LT-3130 Antenna Unit has a built-in heater, which is activated only when the 24 VDC input power source is available.

24 VDC Maximum Power Consumption (Watt)	
System Unit	Power [W]
LT-3110S CU	40.8
LT-3140S IU	10.0
Total Power (maximum)	50.8

Table 13: Maximum Power Consumption (24 VDC input)

12 VDC Maximum Power Consumption (Watt)	
System Units	Power [W]
LT-3110S CU	26.4
LT-3140S IU	10.0
Total Power (maximum)	36.4

Table 14: Maximum Power Consumption (12 VDC input)

The coaxial cable length is an adding factor to the total power consumption of the system. A short coaxial cable will add approximately ~0 W to the total power consumption. Whereas a coaxial cable with a maximum length will add ~16 W (24 VDC input) and ~10 W (12 VDC input) to the total power consumption. The supported coaxial cable lengths for the LT-3100S GMDSS system are described in *LT-3130 Antenna Unit* on page 37.

**Average (transmission/reception)**

The average power consumption for the LT-3100S GMDSS system is listed in Table 15 and Table 16. These power consumption numbers must be used for calculating the battery capacity for GMDSS equipment in accordance with the respective IMO resolution and guidelines.

24 VDC Typical Average Power Consumption (Watt)			
System Units	Transmission [W]	Reception [W]	Comments
LT-3110S CU	37.8	37.8	Maximum cable length.
LT-3140S IU	7.0	7.0	
Total Power (average)	44.8	44.8	

Table 15: Average Power Consumption (24 VDC)

12 VDC Typical Average Power Consumption (Watt)			
System Units	Transmission [W]	Reception [W]	Comments
LT-3110S CU	23.4	17.4	Maximum cable length.
LT-3140S IU	7.0	7.0	
Total Power (average)	30.4	24.4	

Table 16: Average Power Consumption (12 VDC)

**NOTE:** The average power consumption (transmission/reception) is illustrated with maximum coaxial cable length used in Table 15 and Table 16. Using a shorter coaxial cable, will significantly reduce the total power consumption as illustrated in Table 17.

Example: Typical Average Power Consumption 24 VDC (Coaxial Cable FF400LSFROH - 25 to 500m):

This example is illustrating the typical average power consumption for a LT-3100S GMDSS system ( $V_s = 24$  VDC), where 25 to 500m coaxial cable (FF400LSFROH) is listed. The LT-3100S GMDSS system is including the LT-3140S Interface Unit.

24 VDC Typical Average Power Consumption (Watt)			
Cable Length	Transmission [W]	Reception [W]	Comments
25m	~30.0	~30.0	
50m	~31.0	~31.0	
100m	~33.0	~33.0	
200m	~35.0	~35.0	
500m	~45.0	~45.0	Maximum cable length.

Table 17: Example of Typical Average Power Consumption (24 VDC)

## DC Isolation Resistance and Chassis Ground

The LT-3100S GMDSS system must be installed properly with respect to DC isolation resistance and chassis ground. Wrong installations can lead to DC isolation issues (low Ohm meter measuring) on board the vessel and equipment damages. This section will provide details about installation precautions, which must be followed.

LT-3110S Control Unit (back view) with an upscaled power connector are illustrated in Figure 42. The Chassis ground (GNDC) must be connected sufficiently to the vessel ground. 91-102218 Power Cable, 3m must be used to connect the LT-3110S Control Unit to the vessel 12 or 24 VDC power source. DC isolation resistance measured on a disconnected LT-3110S Control Unit between GNDC and VDC (-) > 50 MΩ.

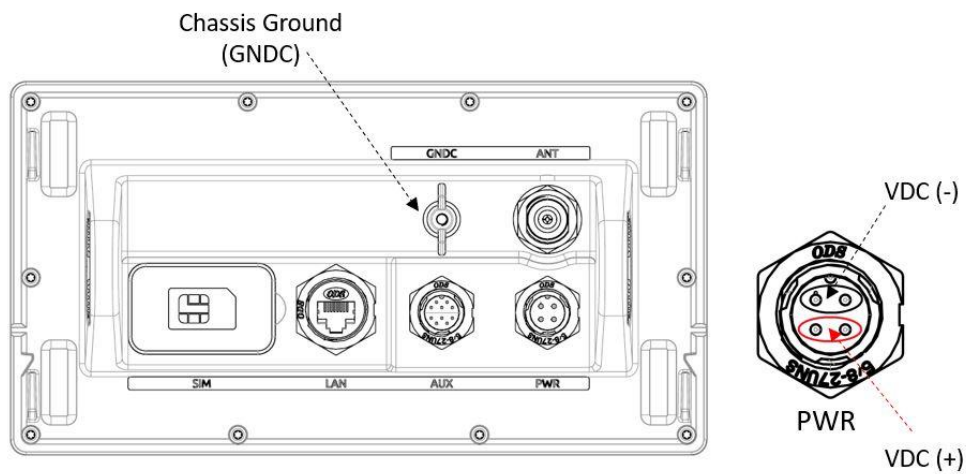

Figure 42: LT-3110S Control Unit (VDC(+), VDC(-), and GNDC)

The LT-3130 Antenna Unit (bottom view) is illustrated in Figure 43. Chassis ground (GNDC) on the LT-3130 Antenna Unit is defined as the mechanics (connected to the mounts).

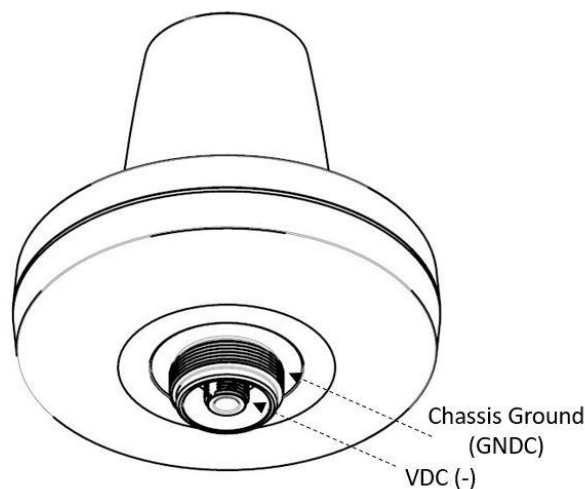

Figure 43: LT-3130 Antenna Unit (VDC(+), VDC(-), and GNDC)

DC isolation resistance measured on a disconnected LT-3130 Antenna Unit between GNDC and VDC (-) > 50 MΩ. VDC (-) and VDC (+) is respectfully the N connector thread and the N connector center conductor. Figure 44 is illustrating the LT-3100S GMDSS system consisting of LT-3110S Control Unit, LT-3130 Antenna Unit, and the coaxial cable connecting these two units.

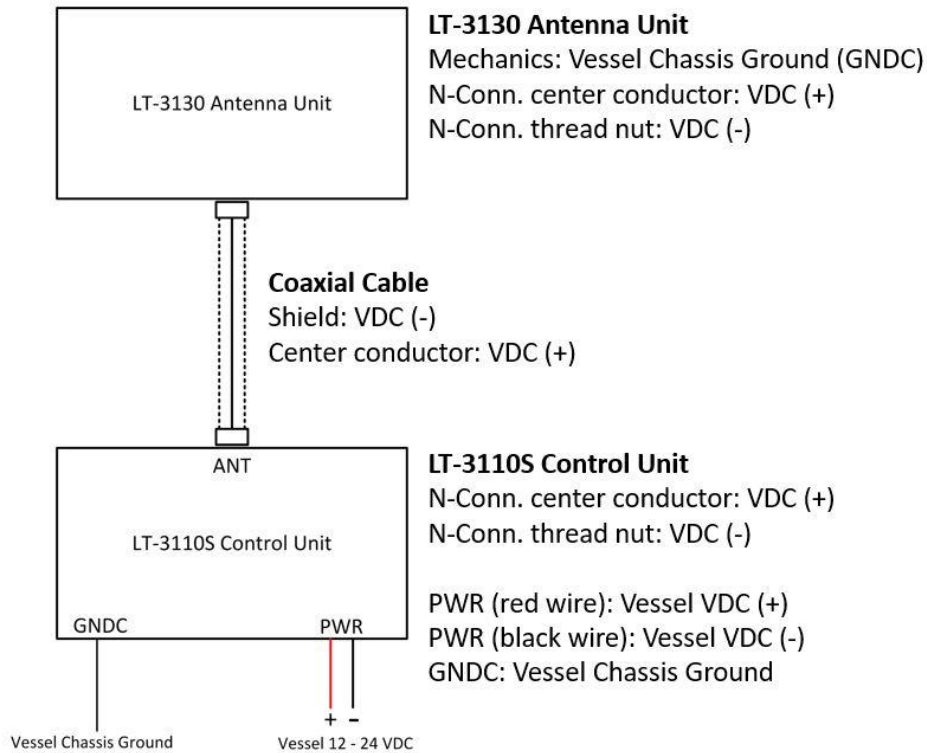

Figure 44: Definitions of VDC (+), VDC (-), and GNDC

It is important that the coaxial cable, connected to both the LT-3110S Control Unit and LT-3130 Antenna Unit, is not grounded in any of the ends. Do not connect the coaxial cable shield to vessel ground. The coaxial cable N connector must only be connected directly to the N connector of the two units.

**NOTE:** Make sure that the LT-3130 Antenna Unit is connected sufficiently to vessel ground. Also, make sure that the N connector on the LT-3130 Antenna Unit, VDC (-) is not connected to the LT-3130 Antenna Unit mechanics, GNDC. It is important to adhere to this requirement so as not to get a bad DC isolation resistance.

## User Interface (UI)

The LT-3100S GMDSS system is controlled from the LT-3110S Control Unit, which is the interface for operating and configuring the system. The control unit has a 4.3" TFT-LCD display, supporting day and night modes. The layout of the display and buttons are illustrated in Figure 45.

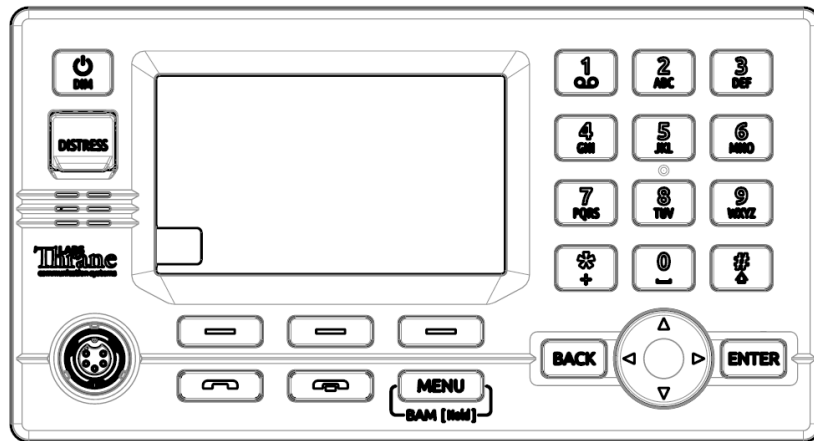

Figure 45: Control Unit (front view) - user interface display and buttons.

The control unit buttons, functions and features, are described in the following groups:

- **Power & DIM button:** The power button can restart the system by pressing the button for 5 seconds. A pop-up box will show the action, and a counter will count down until the system is powered off. If the external power source to the system is re-powered, then the system will power on automatically. To activate the DIM functionality, short press the Power & DIM button. Short press (1 < s); brightness level will change between 7 levels. Long press ( $\geq 1$  s); will change the display mode. The display brightness level and display mode can be changed from the menu as well (MENU -> Settings -> Display).
- **DISTRESS button:** Lift the lid and press the DISTRESS button for a minimum of 3 seconds to activate a Distress. A Distress Activated window will be visible as soon as a Distress has been activated via the DISTRESS button.
- **Off-hook button:** The button is illustrated with a green colored handset. The function of the off-hook button is to activate a call, if the dialed number is available in the display or a contact is selected in the Contacts or Call History. The off-hook button can also be used to accept an incoming call. The alternative to use the off-hook button is to lift the handset out of the cradle. If the off-hook button is used and the handset remain in the cradle, the phone audio will be available in the control unit speaker. The microphone is muted, if the handset remains in the cradle - indicated with an icon in the status bar.
- **On-hook button:** The button is illustrated with a red colored handset. Pressing the on-hook button will terminate an active call.
- **MENU / BAM button:** The MENU button is used to open the main menu. The BACK, Navigation (arrows), and ENTER buttons are used to navigate in the menu. Press the MENU button to exit the menu from anywhere in the menu tree (instead of multiple BACK button presses). Long press (> 1 s) the MENU / BAM button and the BAM Alert List will be shown.
- **Soft keys buttons:** Three soft keys are available in the bottom of the display. The soft keys are used for different purposes and their functions will change in the operation modes of the system.



- **Navigation buttons:** The navigation buttons (BACK, arrows, and ENTER) are used for navigation purposes in the menu layout. In context of user input or when making selections, the BACK button will erase input or cancel editing respectfully, the ENTER button will end input or apply selection respectfully.
- **Numeric Keypad buttons:** The numeric keypad buttons, the '\*' button, and the '+' button can be used for entering digits, letters and special characters. Depending on context, pressing one button in rapid succession (< 1s) will cycle through a selection of letters, digits and/or special characters (e.g. when entering a phone number, pressing the '\*' character twice in succession will result in one '+' character and not two '\*' characters).

An icon in the status bar will show the current input mode, indicating which characters can be cycled - if any. In text mode, the '#' key is used to change between capital and lowercase letters.

### Display

The display contains three sections as illustrated in Figure 46: Status bar, view area and soft keys.



Figure 46: LT-3110S Control Unit (display sections)

The essential system status and system notifications are shown in the status bar, which is always present.

The view area contains the active view. The active view is changed by navigating the UI using the MENU and navigation buttons. The text and function of the soft keys changes dynamically with the active view. The soft keys can also change without changing view depending on the activity in the active view.

The Recommended viewing distance is 68 cm, at which all data is readable under all light conditions.

The general level of the brightness can be varied through 7 steps from 5 cd/m<sup>2</sup> up to 560 cd/m<sup>2</sup> on white background in “Day mode”. The display also has a “Night mode” (inverted graphics) with additional 7 steps.

It has been verified through measurements that dense text information areas on black background emits light equivalent to 1 cd/m<sup>2</sup>. All measurements through all light levels in the two modes demonstrates a minimum contrast level of 350:1.

The status bar has a dedicated section for presenting time and position and 7 slots for system status icons.

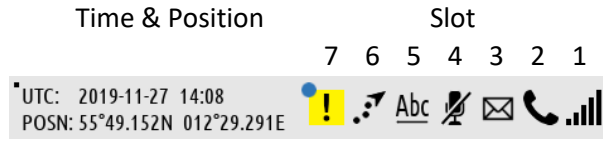

Figure 47: LT-3110S Control Unit (status bar)

**NOTE:** The status bar contains a flashing square in the upper left corner to verify that the display never freezes, see Figure 47 on page 49. The flashing square is always visible on the display. The square is not illustrated on other figures throughout this manual.

Each slot shows the status of one function or group of functions. If a group of functions in a slot has more than one active icon, the slot will continuously take turn showing one icon at a time for a few seconds before cycling to the icon of the next function.

Network Status - Slot 1	
	The LT-3100 system has no satellite signal and is not registered on the Iridium® Network.
	The LT-3100 system has satellite signal = 0 and is registered on the Iridium® Network.
	The LT-3100 system has satellite signal = 1 and registered on the Iridium® Network.
	The LT-3100 system has satellite signal = 5 and registered on the Iridium® Network.

Table 19: LT-3110S Control Unit - status bar (network status)

Iridium Service - Slot 2	
	Active voice call or off-hook mode.
	An external (SIP) phone is in an active voice call.
	There is an active data connection.

Table 18: LT-3110S Control Unit - status bar (Iridium service)



Notifications - Slot 3	
	There are one or more missed calls.
	There are one or more voicemail messages.
	There are one or more unread MSI messages, Safety Messages, SMS or E-mail messages.

Table 20: LT-3110S Control Unit - status bar (notifications)

Audio - Slot 4	
	The microphone on the handset is muted.

Table 21: LT-3110S Control Unit - status bar (audio)

Input Mode - Slot 5	
<u>123</u>	The numeric keypad can be used to enter a phone number or numeric number.
<u>Abc</u>	The numeric keypad can be used to enter text. The first letter of a sentence will be in upper case.
<u>abc</u>	The numeric keypad can be used to enter text. All letters will be in lower case.
<u>ABC</u>	The numeric keypad can be used to enter text. All letters will be in upper case.

Table 22: LT-3110S Control Unit - status bar (input mode)

Miscellaneous Functions - Slot 6	
	The Tracking service is enabled and in periodic mode or enabled and in manual mode currently sending a report.

Table 23: LT-3110S Control Unit - status bar (miscellaneous functions)







BAM Status - Slot 7	
	Active - unacknowledged warning
	Active - silenced warning
	Active - acknowledged warning
	Active - responsibility transferred warning
	Rectified - unacknowledged warning
	Active caution

Table 24: LT-3110S Control Unit - status bar (BAM status)

**Menu System**

The LT-3100S GMDSS system main menu is opened by pressing the MENU button on the keypad. The user will be presented with a layout as illustrated in Figure 48.

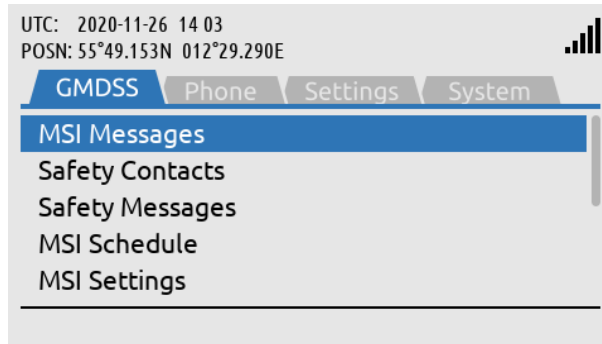
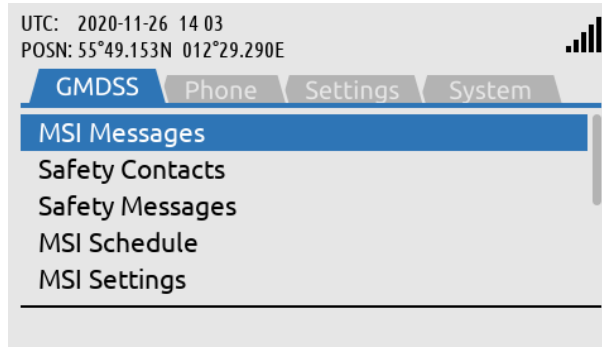

Figure 48: LT-3110S Control Unit (MENU layout)

The main menu is represented by four submenus: GMDSS, Phone, Settings, and System. The four submenus are listed in Table 25.

MENU / Submenu Layout	
Submenus	Entries
GMDSS	MSI Messages Safety Contacts Safety Messages MSI Schedule MSI Settings Distress Settings Position Settings Location Information SES Information Terminal Test
Phone	Contacts SMS Call History
Settings	Audio Display Date & Time Reset Options
System	BAM Alerts Network Tracking SIP Phones Position Status Subscription System Info Power Supply

Table 25: LT-3110S Control Unit (MENU and submenus)



GMDSS submenu:  
MENU -> GMDSS

Figure 49: GMDSS submenu

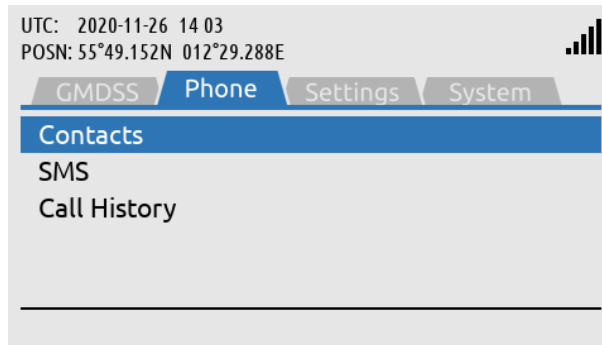

Phone submenu:  
MENU -> Phone

Figure 50: Phone submenu

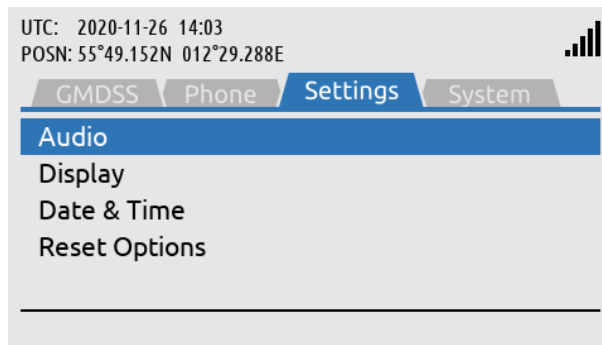

Settings submenu:  
MENU -> Settings

Figure 51: Settings submenu

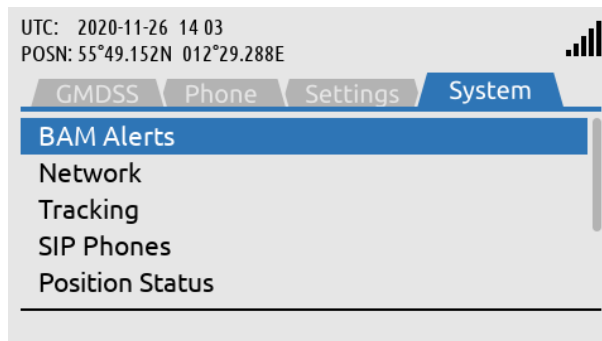

System submenu:  
MENU -> System

Figure 52: System submenu

## Activating the System

A few things must be completed before you can have an operational LT-3100S GMDSS system on board your vessel. It is assumed that you have received the LT-3100S GMDSS system from the Lars Thrane A/S GMDSS certified partner - this could be directly or indirectly. The Lars Thrane A/S GMDSS certified partners have completed technical training and will be able to assist you with all the questions you might have to the product or service. The Lars Thrane A/S GMDSS certified partners are listed on the company's website: <https://www.thrane.eu>

The following steps are required for activating the LT-3100S GMDSS system:

- GMDSS SIM card
- Iridium Maritime Safety Service Activation Form (MSSAF)
- Completing the Installation Wizard
- Completing Radio Survey

The LT-3100S GMDSS system installation and mounting is described in the previous sections. The LT-3100S GMDSS system must complete an Iridium MSSAF form (list the ICCID of the GMDSS SIM card and IMEI number of the LT-3130 Antenna Unit) and all the vessel details, before the Installation Wizard can be started and then activate the system on the Iridium GMDSS System (IGS).

**IMPORTANT:** In order for the LT-3100S GMDSS system to be deemed operational and ready for continuous service: i) it must be correctly installed per the specifications in the User & Installation Manual of the LT-3100S GMDSS Satellite Communications System ("LT-3100S GMDSS User & Installation Manual"), ii) the LT-3100S Installation Wizard must have been completed successfully, and iii) the Iridium GMDSS SIM card, which serves to evidence that a terminal has been subscribed to Iridium's Network, has been secured and correctly installed. The Iridium GMDSS SIM card is at all times required for operation of the GMDSS equipment and is a critical and indispensable part of the LT-3100S GMDSS system. Without a valid Iridium GMDSS SIM card correctly installed and continuously maintained in the inserted position in the LT-3110S Control Unit, pursuant to the instructions in the LT-3100S GMDSS User & Installation Manual, the terminal is not an operational GMDSS terminal and not ready and available for continuous use on any vessel. Vessel operators are mandated by International Maritime Organization regulations to ensure the continued operation of any GMDSS terminal (whether a primary terminal or backup unit) installed on their vessels. The Iridium GMDSS SIM card is, as previously described, required at all times for the proper operation of the Iridium LT-3100S GMDSS system and is considered a critical component of the GMDSS equipment.

### Acquire a GMDSS SIM card

An Iridium GMDSS SIM card must be used for activating a LT-3100S GMDSS system. The GMDSS SIM card is described and illustrated in *GMDSS SIM card (SIM)* on page 31. The GMDSS SIM card may be acquired directly from your Lars Thrane A/S certified partner. The ICCID number (uniquely identifies the GMDSS SIM card) must be used for completing the Iridium MSSAF form. The GMDSS SIM card must be inserted in the LT-3110S Control Unit before powering up the system and starting the Installation Wizard. The Installation Wizard is described in *Installation Wizard* on page 57.

### Maritime Safety Service Activation Form (MSSAF)

To complete the Iridium Maritime Safety Service Activation Form (MSSAF), you must contact your Iridium GMDSS Service Provider (SP) or Lars Thrane A/S GMDSS certified partner. The Iridium website will have an up-to-date list of approved Iridium GMDSS Service Providers (SP):

<https://www.iridium.com/services/gmdss/>

Table 26 provides an overview of the details required in order to complete the MSSAF. The Iridium GMDSS Service provider (SP) might require further details, hereunder accounting.

Maritime Safety Service Activation Form (MSSAF)	
Vessel Information	Terminal Information
Vessel Name	SOLAS Vessel (yes or no)
Vessel Type	SES1 or SES2
Vessel Build Year	IMEI (system identification)
Vessel Tonnage	ICCID (GMDSS SIM Card)
Vessel Fleet Name	Type of Terminal
Vessel Nation Flag	
Vessel IMO No.	Emergency Contact Details:
Vessel MMSI	Company / Name (incl. address)
Vessel Call Sign	Emergency Contact Name
Vessel Port of Registry	Emergency Phone
Vessel Person Capacity	Emergency E-mail

Table 26: MSSAF (details required)

**IMPORTANT:** The person completing the MSSAF is fully responsible for the information provided - Vessel and Terminal Information must match the actual data.

**NOTE:** The Iridium GMDSS Service Provider (SP) might use another wording for the Iridium Maritime Safety Service Activation Form (MSSAF). However, it is recommended referring to the MSSAF when contacting your Iridium GMDSS Service Provider (SP) or Lars Thrane A/S GMDSS certified partner.



### Who's My Service Provider

Iridium has a website where they inform about the specific Service Provider (SP) who has activated the LT-3100S GMDSS system (or any other Iridium activated product).

Use the following link: <https://www.iridium.com/who-is-my-sp/>

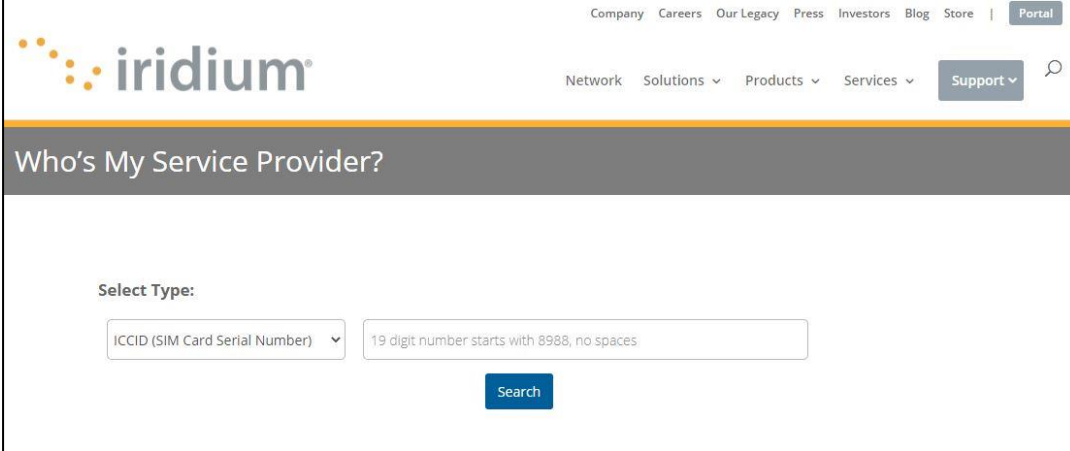

The screenshot shows the Iridium website's 'Who's My Service Provider' page. The page has a white background with a grey header bar. The Iridium logo is in the top left. The navigation menu includes 'Company', 'Careers', 'Our Legacy', 'Press', 'Investors', 'Blog', 'Store', and 'Portal'. Below the navigation, there are links for 'Network', 'Solutions', 'Products', 'Services', and 'Support'. The main heading is 'Who's My Service Provider?'. Below this, there is a form with a 'Select Type:' label, a dropdown menu set to 'ICCID (SIM Card Serial Number)', and a text input field with the placeholder '19 digit number starts with 8988, no spaces'. A blue 'Search' button is positioned below the input fields.

Figure 53: Iridium - Who's My Service Provider

You can use the following information:

- ICCID (GMDSS SIM card serial number)
- MSISDN (Mobile Subscriber ISDN number)

**NOTE:** The Iridium GMDSS Service Provider (SP) must be contacted for any changes to the GMDSS provisioning. 'Who's My Service Provider' will inform you where your LT-3100S GMDSS system is provisioned.

**Installation Wizard**

The Installation Wizard must be completed after the installation has been finished and the LT-3100S GMDSS system is powered up for the first time. The Installation Wizard consist of the following steps: Detection of Wizard, MENU Key, System Settings, System Configuration, Download GMDSS Configuration, Select Distress RCC, System Verification, and System Activation, as illustrated in Table 27. The LT-3100S GMDSS system will only be fully functional and legal to operate when the Instllation Wizard has been completed and the following text has been showed as an end of the Installation Wizard: 'The system is now ready for use.'

**NOTE:** The Iridium GMDSS System (IGS) may send the LT-3100S GMDSS system an updated GMDSS Configuration file as changes in the IGS requires this (e.g. new RCC added). The GMDSS Configuration file will automatically be pushed to the LT-3100S GMDSS system.

Installation vs. Service Wizard			
Steps	Installation Wizard	Service Wizard	Comments
Detection of Wizard	X	X	Installation or Service
MENU Key	X	-	Details available
System Settings	X	-	
System Configuration	X	X	
Download GMDSS Configuration	X	X	
Select Distress RCC	X	-	Automatic or Manual
System Verification	X	X	Distress Alert, Distress Call, and MSI.
System Activation (OTA)	X	X	Over-the-Air (OTA)

Table 27: Installation vs. Service Wizard

**NOTE:** The LT-3100S GMDSS system must use a correct Iridium GMDSS SIM card, which is received and activated from you Iridium GMDSS Service Provider (SP) or a Lars Thrane A/S GMDSS certified partner. Make sure that the LT-3100S GMDSS system and the GMDSS SIM card is activated correctly prior to running the Installation Wizard, as described and illustrated in this section.

**IMPORTANT:** The LT-3100S GMDSS system will not be functional before the Installation Wizard has succesfully been completed. Please contact your Iridium GMDSS Service Provider (SP) or Lars Thrane A/S GMDSS certified partner to handle any potential problem.

Detection of Wizard

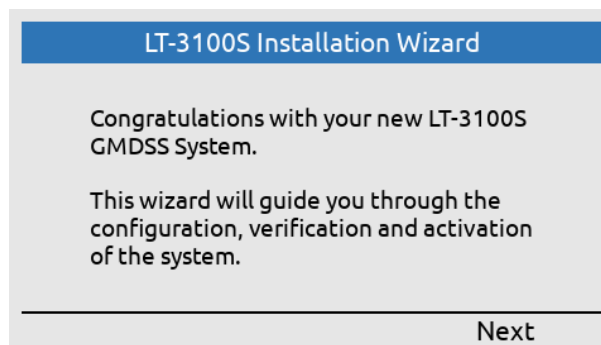

The Installation Wizard will be displayed when powering up the system initially, and until activation completed.

Figure 54: Installation Wizard (1 of 29)

MENU Key

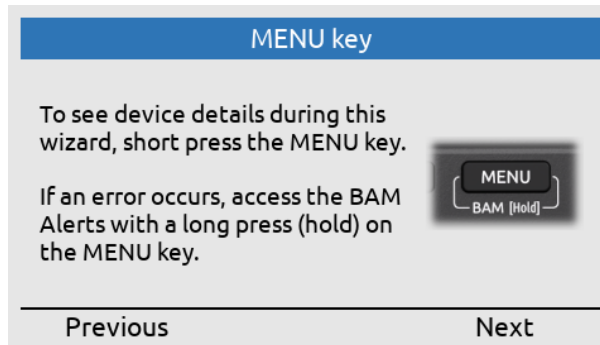

The MENU key can be used to access details (short press) during completion of the Installation Wizard.

Figure 55: Installation Wizard (2 of 29)

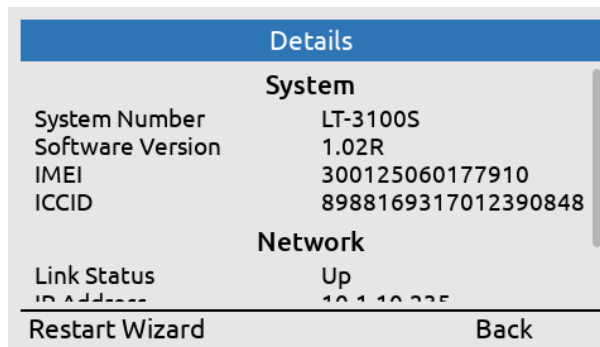

Details information (part 1 of 2).

Figure 56: Installation Wizard (3 of 29)

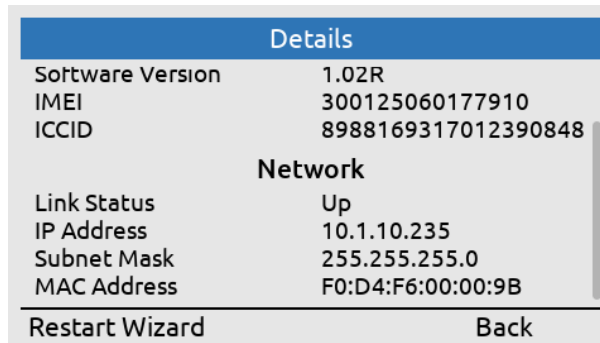

Details information (part 2 of 2).

Figure 57: Installation Wizard (4 of 29)

System Settings

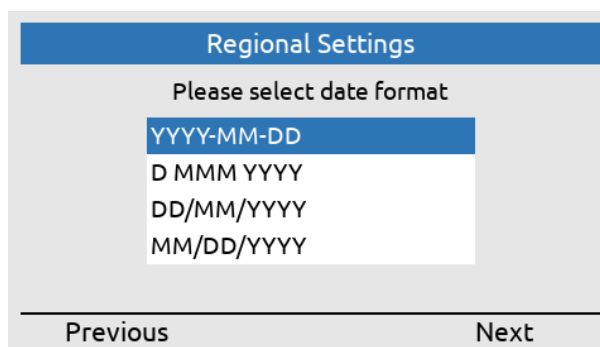

Select date format.

Figure 58: Installation Wizard (5 of 29)

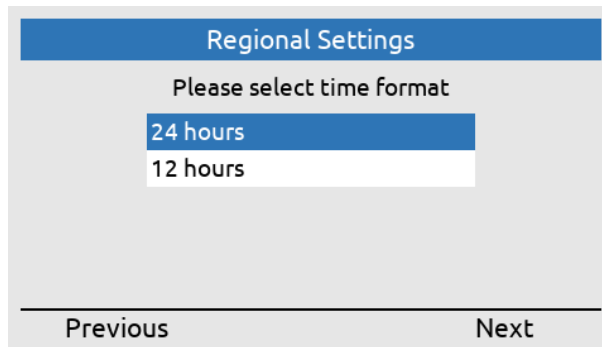

Select time format.

Figure 59: Installation Wizard (6 of 29)

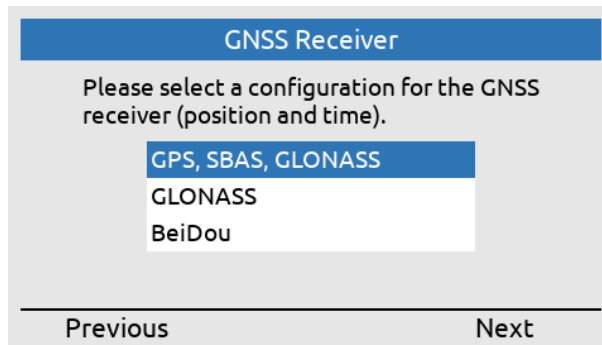

Select GNSS receiver configuration (can be configured via the web server at another time).

Figure 60: Installation Wizard (7 of 29)

System Configuration

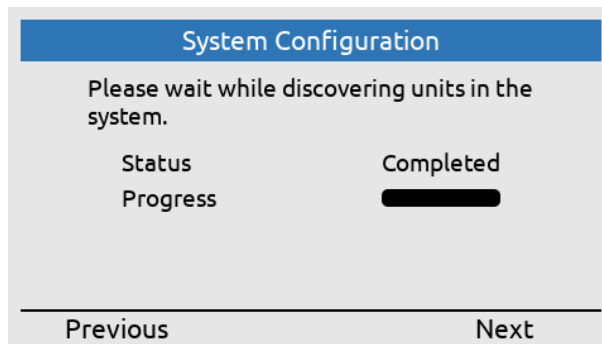

The LT-3110S CU is searching for LT-3100S GMDSS system units part of the setup.

Figure 61: Installation Wizard (8 of 29)

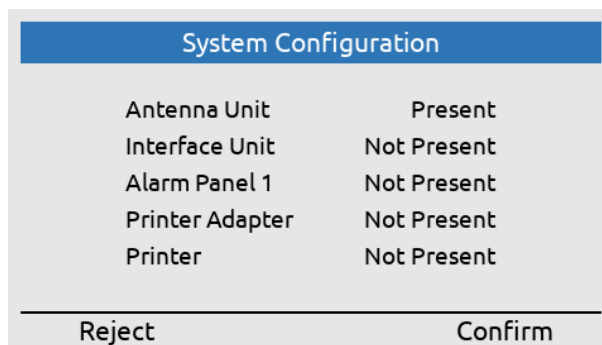

The LT-3110S CU has identified the following LT-3100S GMDSS system units, please confirm.

Figure 62: Installation Wizard (9 of 29)

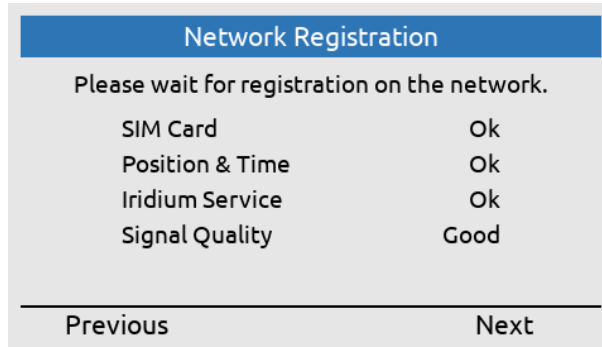

Check that everything is ready for starting the configuration of the LT-3100S GMDSS system towards the Iridium network.

Figure 63: Installation Wizard (10 of 29)

Download GMDSS Configuration

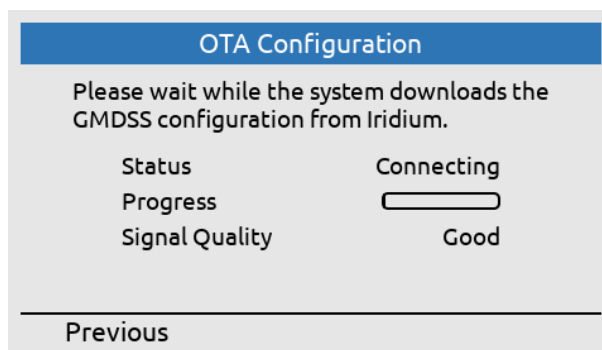

The LT-3100S GMDSS system is downloading the GMDSS Configuration file (connecting).

Figure 64: Installation Wizard (11 of 29)

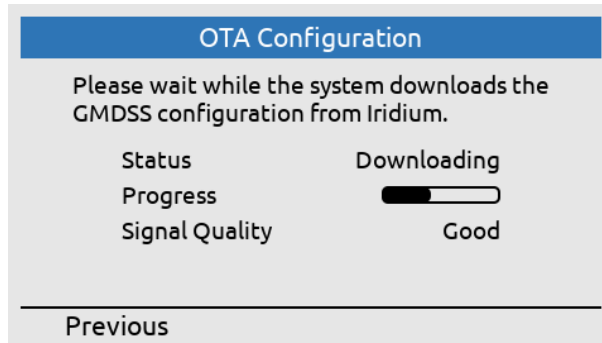

The LT-3100S GMDSS system is downloading the GMDSS Configuration file (downloading).

Figure 65: Installation Wizard (12 of 29)

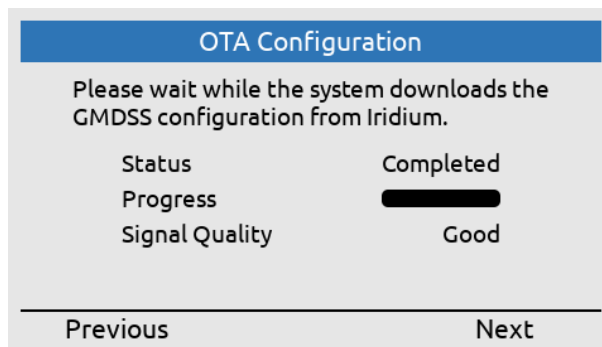

The LT-3100S GMDSS system has downloaded the GMDSS Configuration file (completed).

Figure 66: Installation Wizard (13 of 29)

Verify the vessel details, which are provided in the Maritime Safety Service Activation Form (MSSAF) 'Iridium activation form'.

Figure 67: Installation Wizard (14 of 29)

Verify the Ship Earth Station Name (SES1 or SES2).

Figure 68: Installation Wizard (15 of 29)

Select Distress RCC

Select Distress RCC: Automatic or Manual (can be configured in Distress Settings at another time).

Figure 69: Installation Wizard (16 of 29)

System Verification

The configuration has been completed. Now the GMDSS Safety Service functions must be verified.

Figure 70: Installation Wizard (17 of 29)

**IMPORTANT:** The LT-3100S GMDSS system has now been configured. In order to verify that the LT-3100S GMDSS system GMDSS Safety Functions (Distress Alert, Distress Call, and MSI) are working correctly - these functions will now be tested. The LT-3100S GMDSS system is sending the Distress Alert in 'test mode'. The Distress Call will be connected to a voice prompt, reaching the Iridium GMDSS Server (IGS). A Rescue Coordination Center (RCC) will not be involved as part of the testing and verification.

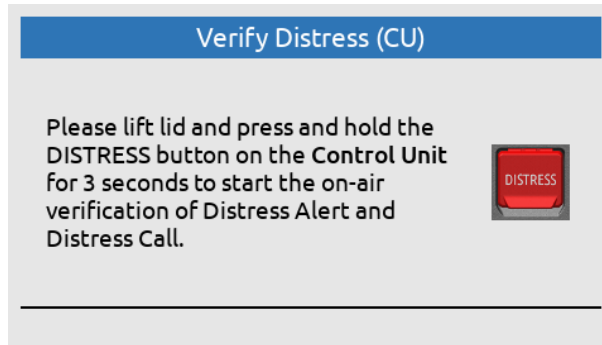

Lift the lid and press the DISTRESS button on the LT-3110S Control Unit.

Figure 71: Installation Wizard (18 of 29)

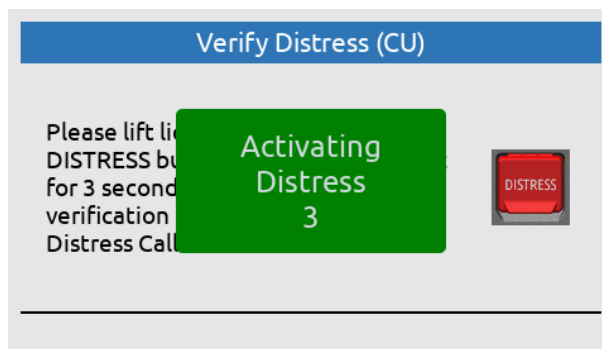

The DISTRESS button must be held for a minimum of 3 seconds to activate a Distress.

Figure 72: Installation Wizard (19 of 29)

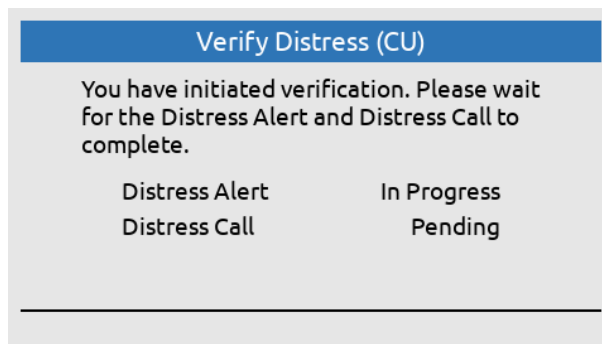

Verify Distress (CU):  
Distress Alert: In progress

Figure 73: Installation Wizard (20 of 29)





System Activation

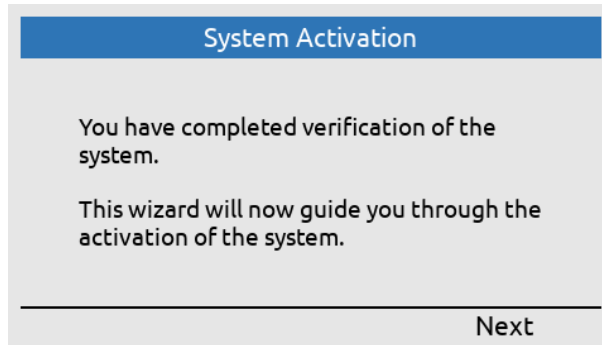

Verification of Distress GMDSS Safety Service functions has been completed successfully.

Figure 78: Installation Wizard (25 of 29)

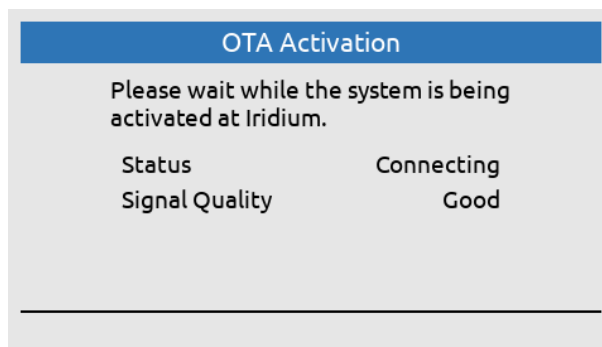

OTA Activation:  
Status: Connecting  
(Over-The-Air)

Figure 79: Installation Wizard (26 of 29)

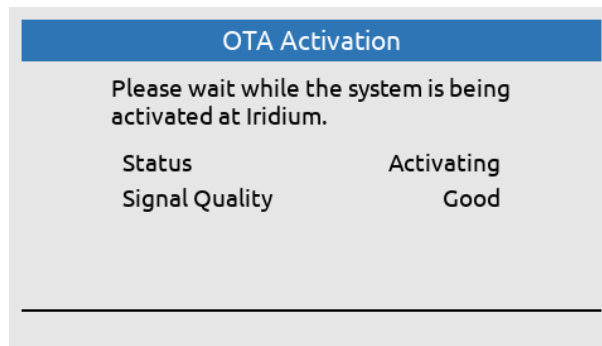

OTA Activation:  
Status: Activating

Figure 80: Installation Wizard (27 of 29)

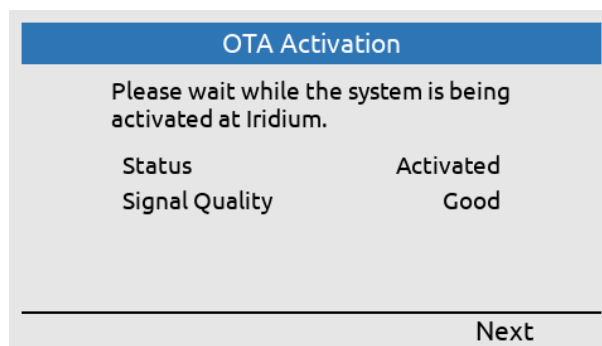

OTA Activation:  
Status: Activated

Figure 81: Installation Wizard (28 of 29)

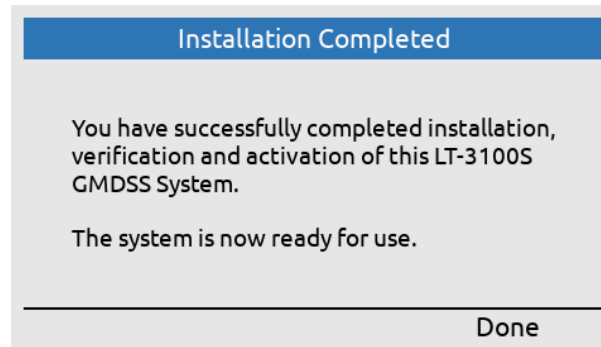

The LT-3100S GMDSS system has now been successfully activated - the system is ready for use.

*Figure 82: Installation Wizard (29 of 29)*

The Installation Wizard has now been completed successfully and the LT-3100S GMDSS System is now ready for use!

**NOTE:** The Installation Wizard will be displayed after powering up of the LT-3100S GMDSS system initially or if the system has been factory reset from the web server.

## Radio Survey

Once the LT-3100S GMDSS system has been physically installed, connected, and the Installation Wizard has been completed successfully, the system must be verified by conducting a GMDSS Radio Survey by an authorized person representing a Classification Society (e.g. DNV-GL). The GMDSS Radio Survey must be completed by a person who has received technical training directly or indirectly and understand the capabilities and services of the LT-3100S GMDSS system. National flag authorities and their regulations for radio survey must be followed.

**IMPORTANT:** The LT-3100S GMDSS system operational status cannot be considered seaworthy, before an official GMDSS Radio Survey has been completed successfully, accordingly to the SOLAS IMO resolutions.

## Test of Distress Alert & Call, and MSI

The LT-3100S GMDSS system support test of Distress Alert, Distress Call, and MSI (in test mode). These tests are performed as part of the following LT-3100S GMDSS system functions:

- Installation Wizard (see *Installation Wizard* on page 57)
- Service Wizard (see *Service Wizard* on page 69)
- Terminal Test (see *Terminal Test* on page 117) - can be activated by the user at any time

In test mode, the LT-3100S GMDSS system is verifying the Distress functions towards the Iridium GMDSS System (IGS), indicating test mode and therefore the Rescue Coordination Centers (RCC) will not be involved.

**NOTE:** In test mode, when activating the Distress button, the pop-up window color is green to indicate that the LT-3100S GMDSS system is in test mode and therefore the RCCs will not be involved.

## Change of Hardware and Software

The LT-3100S GMDSS system will initially be configured, verified, and activated by guidance of the Installation Wizard, as described and illustrated in *Installation Wizard* on page 57. Hereafter, if system units are replaced or the LT-3100S GMDSS system is updated with new software, then the Service Wizard will detect this and help the user with the configuration, verification, and re-activation. The Service Wizard is described and illustrated in *Service Wizard* on page 69.

### Change of Hardware

This section will provide some guidance on replacing system units and what the user of the LT-3100S GMDSS system should be aware of, see Table 28.

Change of Hardware		
Hardware	Procedure	Comments
LT-3110S Control Unit	The LT-3110S CU can be replaced by swapping the hardware and running the Installation Wizard. Remember the GMDSS SIM card from the 'old' LT-3110S CU.	All user data (contacts, call history, SMS, and MSI) will be lost, since the LT-3110S CU is the 'master' of the system.
LT-3120 Handset	Change hardware.	Test the new hardware.
LT-3121 Cradle		
LT-3130 Antenna Unit	The LT-3130 AU can be replaced with a new LT-3130 AU, but the Iridium GMDSS Service Provider must be involved. The IMEI number of the new LT-3130 AU must be updated on the GMDSS provisioning before the new LT-3130 AU is connected to the LT-3110S CU and the system is powered up. The Service Wizard will detect the new LT-3130 AU and help the user with the configuration, verification, and re-activation on the Iridium GMDSS System (IGS).	
LT-3140S Interface Unit	The Service Wizard will detect the new unit and help the user with the configuration, verification, and re-activation on the Iridium GMDSS System (IGS).	
LT-3150S Alarm Panel		
LT-3160S Printer Adapter		
GMDSS SIM Card	The GMDSS SIM card can be replaced with a new GMDSS SIM card, but the Iridium GMDSS Service Provider must be involved. The ICCID number of the new GMDSS SIM card must be updated on the GMDSS provisioning before the new GMDSS SIM card is inserted in the LT-3110S CU and the system is powered up. The Service Wizard will detect the new GMDSS SIM card and help the user with the configuration, verification, and re-activation on the Iridium GMDSS System (IGS).	Only a GMDSS SIM card can be used in the LT-3100S GMDSS system.

Table 28: Change of Hardware in the LT-3100S GMDSS system

Always remove the DC input power to the LT-3100S GMDSS system when changing the hardware and system units.

**NOTE:** Changing the LT-3130 Antenna Unit or the GMDSS SIM card requires involving of the Iridium GMDSS Service Provider (SP) and GMDSS provisioning. For details of the Iridium GMDSS Service Provider (SP), see *Activating the System* on page 54.

**NOTE:** If moving a LT-3100S GMDSS system from one vessel to another vessel, then make sure to change all vessel and safety contact details in the GMDSS provisioning, i.e. in the Iridium Maritime Safety Service Activation Form (MSSAF). The MSSAF form is described in *Maritime Safety Service Activation Form (MSSAF)* on page 55.

### Software update

The LT-3100S GMDSS system must be software updated by using the web server, configuration - software update, see *Software update* on page 176. Accessing the web server is described in *Accessing the built-in web server* on page 157. The software update procedure will automatically update all system units connected to the LT-3110S Control Unit. The Lars Thrane Image (LTI-file) e.g. LT-3100S-v1.02R-0040.Iti will include all software components to all system units. All system units connected to the LT-3110S Control Unit will be upgraded or downgraded to be aligned with the LT-3110S Control Unit, which is the 'master' of the system. As soon as the software update procedure is started, the LT-3110S Control Unit window will indicate 'Software update in progress' as illustrated in Figure 83.

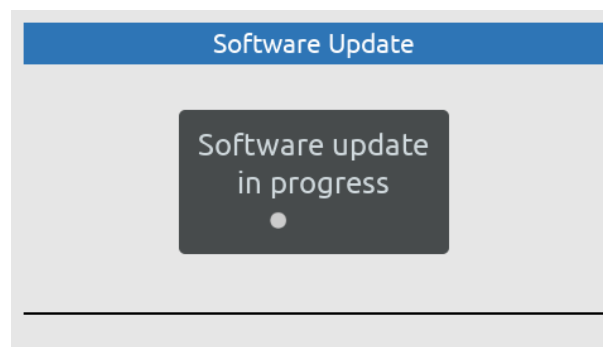

Figure 83: Software update

Once, the LT-3100S GMDSS system has finalized the software update, the system will reboot and startup showing the Service Wizard, as illustrated in Figure 84 on page 69. To finalize the software update, complete the Service Wizard.

**NOTE:** Please check the Lars Thrane A/S company website for newest available software for the LT-3100S GMDSS system.

**Service Wizard**

The Service Wizard is a guidance tool to help the user of the LT-3100S GMDSS system to help complete hardware changes or software updates. The Service Wizard is very similar to the Installation Wizard, which is described in *Installation Wizard* on page 57. The Service Wizard is activated as defined in Table 29.

Service Wizard		
System change	Activated	Comments
New software	Yes	
New LT-3130 AU	Yes	IMEI must be changed for the GMDSS provisioning.
New GMDSS SIM card	Yes	ICCID must be changed for the GMDSS provisioning.

Table 29: Service Wizard

**NOTE:** The difference between the Installation and Service Wizard is illustrated in Table 27 on page 57. The Service Wizard is activated when system changes are made to the LT-3100S GMDSS system, where it is needed to check for a new GMDSS configuration file and re-activate the system on the Iridium GMDSS System (IGS).

Figure 84 is illustrating the activation of the Service Wizard due to a software update of the LT-3100S GMDSS system. Press the softkey 'Next' to start the Service Wizard. Figure 85 is illustrating the last window for completing the Service Wizard. Additional steps are illustrated in *Installation Wizard* on page 57.

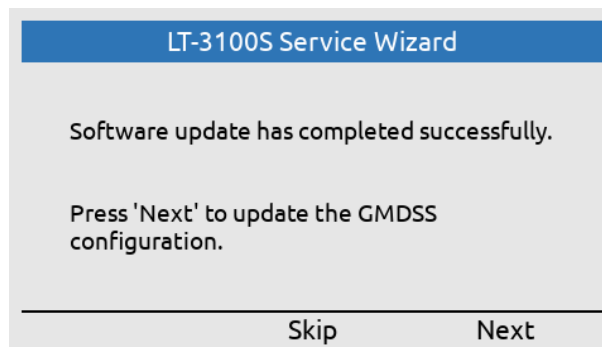

Figure 84: Service Wizard (software update)

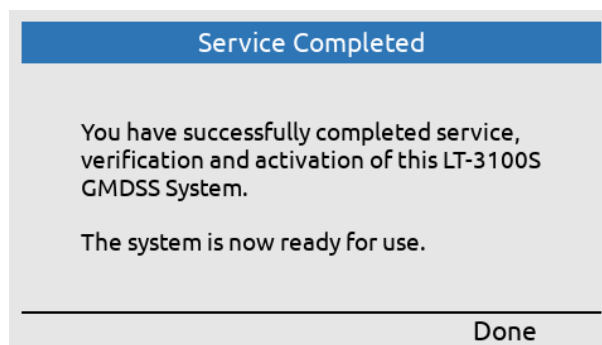

Figure 85: Service Wizard (completed)

## GMDSS Services

The LT-3100S GMDSS system support both GMDSS services, as well as non-GMDSS services. The GMDSS services supported by the LT-3100S GMDSS system are listed here:

- Distress Alert & Distress Call
- Distress Alert Relay
- Maritime Safety Information (MSI)
- Safety Calling
- Safety Messaging

The above listed GMDSS services are all described in further detail in this section. The non-GMDSS services are described in *System Services* on page 120.

Service	Direction	Priority			
		Distress	Urgency	Safety	Routine
Distress Alert	MO	X	-	-	-
MSI (Incl. Distress Alert Relay)	MT	X	X	X	-
Safety Calling	MO, MT	X	X	X	-
Safety Messaging	MO, MT	X	X	X	-
General Calling (Voice Call)	MO, MT	-	-	-	X
General Messaging (SMS)	MO, MT	-	-	-	X

Table 30: LT-3100S GMDSS System Services and Priorities

**IMPORTANT:** A mobile originated (MO) Safety Call of Distress priority can only be initiated, if Distress is activated by using the DISTRESS button. This also applies to Safety Messaging.

The LT-3100S GMDSS and Non-GMDSS Services are listed in Table 30. For all the services, the supported priorities are shown (Distress, Urgency, Safety, and Routine). The LT-3100S GMDSS system support priority and preemption for Mobile Originated (MO) and Mobile Terminated (MT) services.

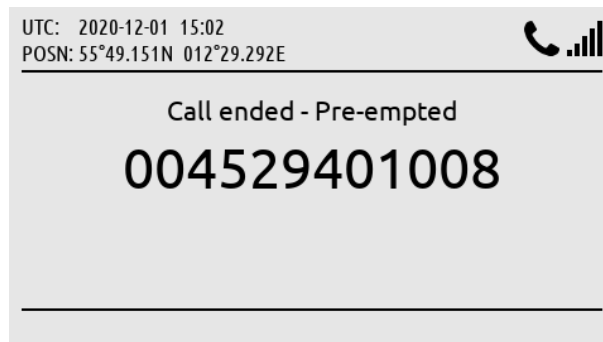

Figure 86: Voice Call (preempted)

If a service with higher priority is required, the service with lower priority will be preempted automatically by the LT-3100S GMDSS system or by the Iridium GMDSS System (IGS). An example of a voice call being preempted by the Iridium GMDSS System (IGS) is illustrated above.

### Distress Alert & Distress Call

The Distress can be activated using the DISTRESS button on the LT-3110S Control Unit or from the DISTRESS button on the LT-3150S Alarm Panel. The LT-3150S Alarm Panel shall be connected via the LT-3140S Interface Unit, up to 3 external LT-3150S Alarm Panels can be connected to the system.

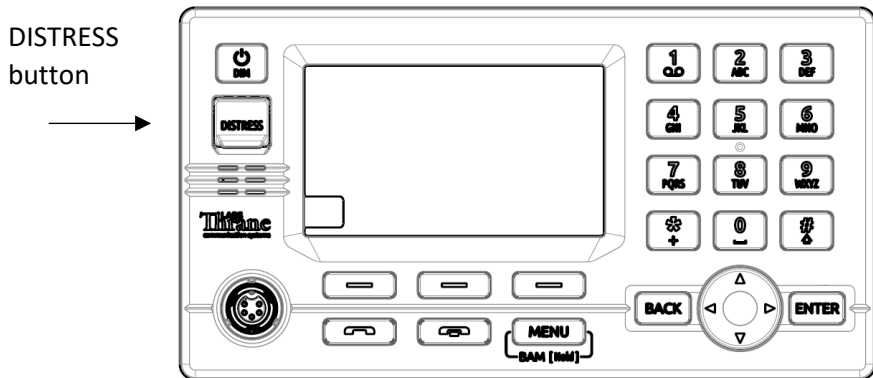

Figure 88: LT-3110S Control Unit (DISTRESS button)

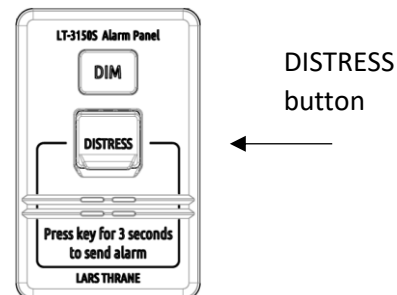

Figure 87: LT-3150S Alarm Panel (DISTRESS button)

The procedure for activating the Distress is the same for all DISTRESS buttons:

1. Lift the red lid marked DISTRESS
2. Press and hold the red DISTRESS button for a minimum 3 seconds (a distress tone will be played immediately when pushing the DISTRESS button)
3. The Distress will be activated in the LT-3100S GMDSS system after 3 seconds - indicated by distress tone stopping
4. Hereafter you can release the DISTRESS button (the light in the red button is now on maximum intensity)

**IMPORTANT:** After activating Distress from an external LT-3150S Alarm Panel, it is recommended to check the status of the Distress by verifying the display information on the LT-3110S Control Unit, where Distress delivery status will be presented (e.g. Distress Alert Status = Sending, Sent, Delivered, and Acknowledged).

The Distress will preempt any other service (voice or data), if needed.

**IMPORTANT:** By default, the LT-3100S GMDSS system is configured to complete a Distress Alert message followed by a Distress Call to a Rescue Coordination Center (RCC) after the DISTRESS button has been activated. A configuration of the LT-3100S GMDSS system is available, where the system will not automatically make the Distress Call to the RCC, when the DISTRESS button has been activated. If the LT-3100S GMDSS system has been configured not to automatically call the RCC, then this Distress Call can manually be initiated from a soft key after the Distress Alert has been delivered.



This section will illustrate and explain how to activate a Distress from the LT-3110S Control Unit. After the Distress has been activated (pushing the DISTRESS button for more than 3 seconds) status information will be available, i.e. providing Distress Alert Status delivery information.

The following Distress activities will be illustrated in this section:

- Activation of Distress (Distress Alert & Distress Call) - Distress Settings, Auto-dial = Enabled
- Select Nature of Distress
- Canceling Distress

**IMPORTANT:** It is possible to activate Distress from either the LT-3110S Control Unit or from the LT-3150S Alarm Panel (if any external LT-3150S Alarm Panels are part of the system configuration). The LT-3110S Control Unit is providing detailed information about the Distress Alert and Distress Call status and therefore it is recommended to check this unit after activation of Distress. Only from the LT-3110S Control Unit you will be able to get in contact with the Rescue Coordination Center (RCC) via the LT-3120 Handset.

Activation of Distress (Distress Alert & Distress Call)



LT-3110S Control Unit, default window.

Figure 89: Activating Distress (1 of 9)

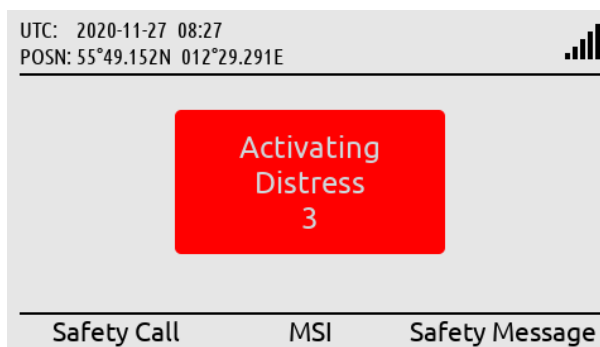

Activation of Distress: DISTRESS button must be held for a minimum of 3 seconds to activate a Distress.

Figure 90: Activating Distress (2 of 9)

**NOTE:** In this example a test RCC has been used to illustrate the Distress (East\_TEST\_RCC).

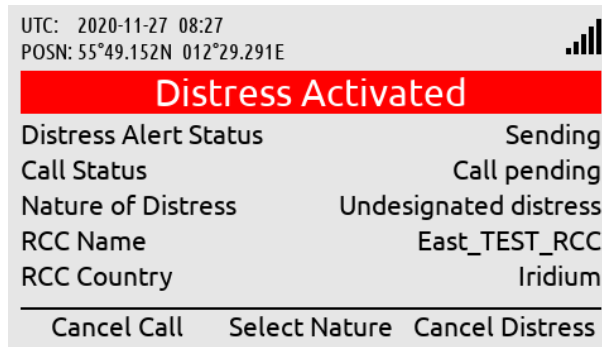

Distress Alert Status = Sending.

Figure 91: Activating Distress (3 of 9)

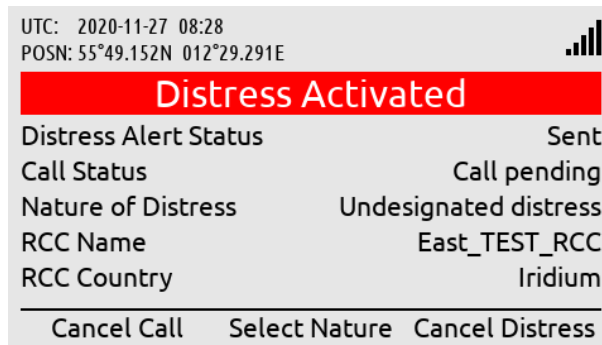

Distress Alert Status = Sent.

Figure 92: Activating Distress (4 of 9)

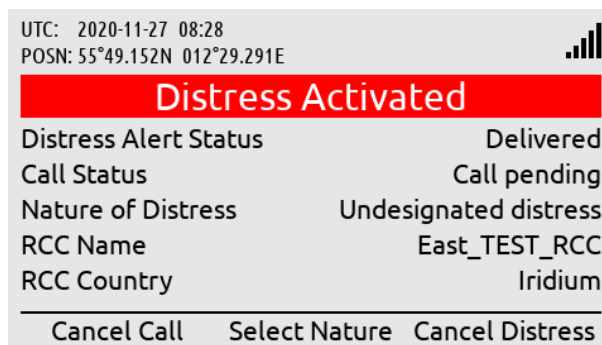

Distress Alert Status = Delivered (Iridium GMDSS System has received the Distress Alert message).

Figure 93: Activating Distress (5 of 9)

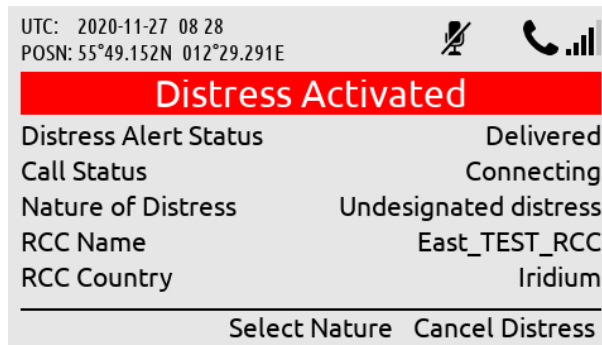

Call Status = Connecting (if Auto-dial = Enabled, then a Distress Call will automatically be established to a RCC).

Figure 94: Activating Distress (6 of 9)

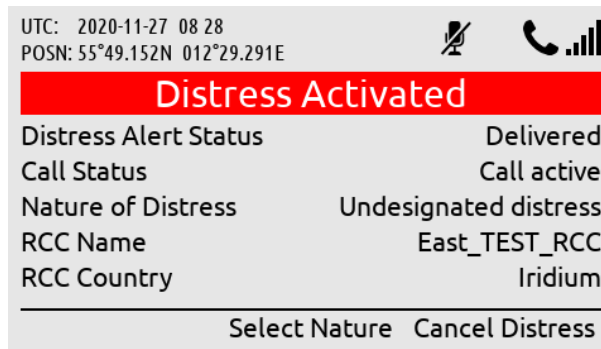

Call Status = Call active  
(Distress Call has now been established to the RCC).

Figure 95: Activating Distress (7 of 9)

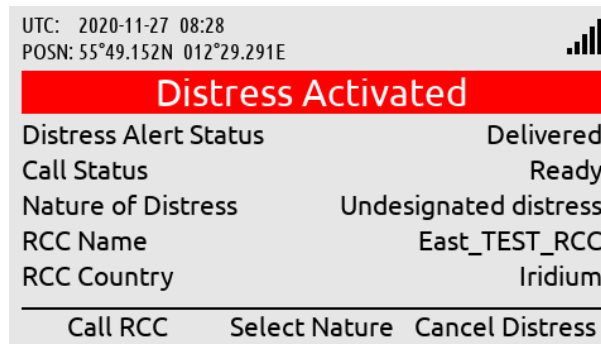

Call Status = Ready  
(Distress Call has been disconnected to the RCC).  
Use soft key 'Call RCC' to activate a new Distress Call.

Figure 96: Activating Distress (8 of 9)

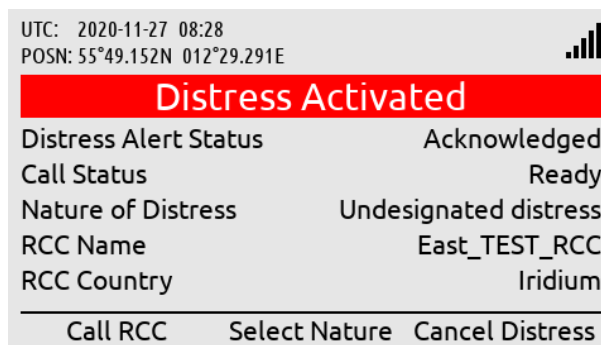

Distress Alert Status = Acknowledged  
(Distress Alert message has manually been acknowledged by the RCC).

Figure 97: Activating Distress (9 of 9)

**IMPORTANT:** After the Distress Alert message has been acknowledged by the Iridium GMDSS System (IGS), the system will automatically make a Distress Call to the configured RCC, if the “auto-dial” setting is enabled.

A Distress Call can be established to the RCC any time after the Distress Alert message has been acknowledged by the Iridium GMDSS System (IGS). If the “auto-dial” setting is enabled, a Distress Call is automatically established after acknowledgement has been received (~Delivered). To manually activate a Distress Call, press the soft key ‘Call RCC’ and lift the handset out of the cradle when the call is connected.

Select Nature of Distress

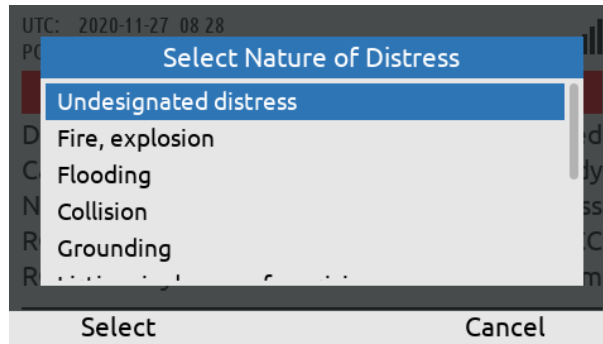

Use the soft key 'Select Nature' to send Nature of Distress information to the RCC.

Figure 98: Select Nature of Distress (1 of 4)

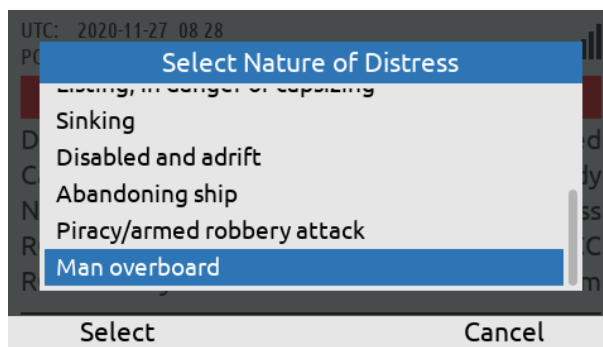

Use the Navigation key (arrow up/down) to select the Nature of Distress and select.

Figure 99: Select Nature of Distress (2 of 4)

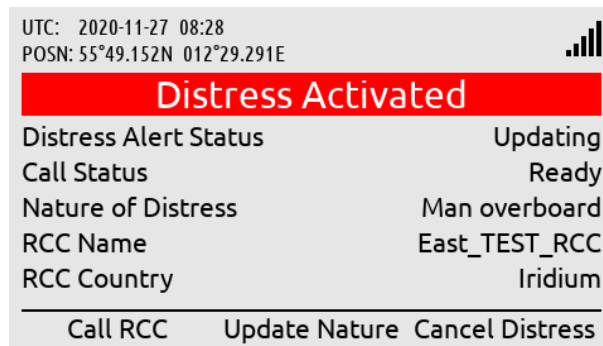

An updated Distress Alert message will now be sent to the RCC with the Nature of Distress information (e.g. Man overboard).

Figure 100: Select Nature of Distress (3 of 4)

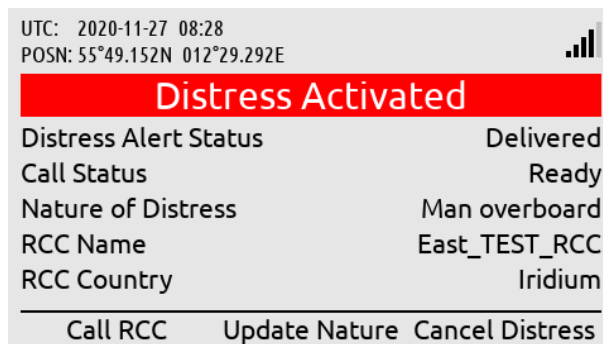

The updated Distress Alert message will only be acknowledged by the Iridium GMDSS System (IGS) to indicate 'Delivered' for the Distress Alert Status.

Figure 101: Select Nature of Distress (4 of 4)

**NOTE:** The Nature of Distress can be selected before (MENU -> GMDSS -> Distress Settings: Nature of Distress) or after (soft key 'Select Nature' or 'Update Nature') activation of the Distress.

Cancelling Distress

To cancel a Distress, press the soft key 'Cancel Distress' and confirm the decision. The LT-3100S GMDSS system will notify the RCC that the Distress has been cancelled.

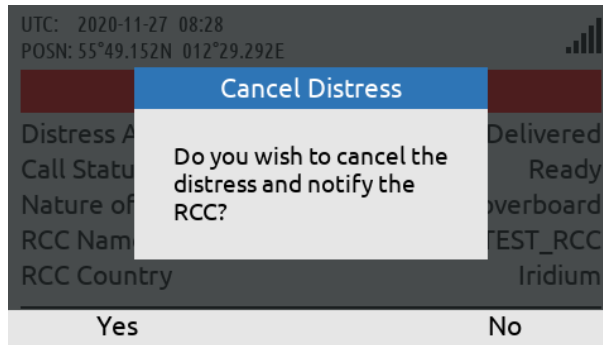

To cancel a Distress, use the soft key 'Cancel Distress' and confirm.

Figure 102: Cancelling Distress (1 of 3)

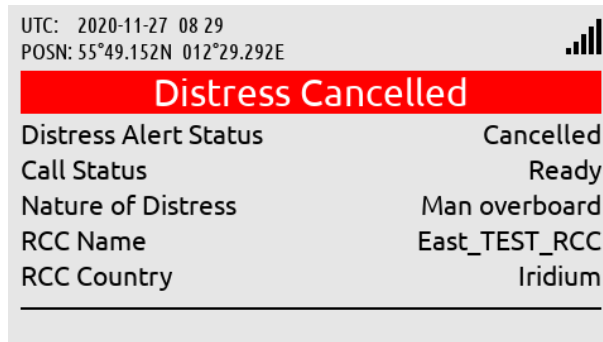

A Distress Alert message indicating Cancelled will be sent to the Iridium GMDSS System (IGS) and the RCC.

Figure 103: Cancelling Distress (2 of 3)



The LT-3100S GMDSS system will now be back to the default window and operation.

Figure 104: Cancelling Distress (3 of 3)

### Distress Alert Relay

This section is illustrating the LT-3100S GMDSS system behavior when a Distress Alert Relay message is received from a Rescue Coordination Center (RCC). A Distress Alert Relay message is sent by an RCC to a predefined area (e.g. a circular area of radius 50 NM) when another vessel nearby has sent a Distress Alert message and assistance is required. The Distress Alert Relay message will contain information from the vessel in Distress. The Distress Alert Relay message will be available in the MSI (inbox). By pushing the soft key 'MSI(X)' the operator of the system will be directed to the MSI (inbox) for reading the incoming message. The following figures, Figure 105 to Figure 110, are illustrating the reception of a Distress Alert Relay message, sent from an RCC.

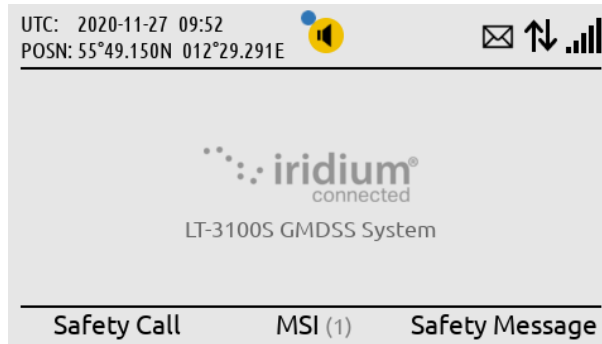

The LT-3100S GMDSS System has received a new MSI message with priority of Urgency or Distress (deduced from the BAM indication).

Figure 105: Distress Alert Relay (1 of 6)

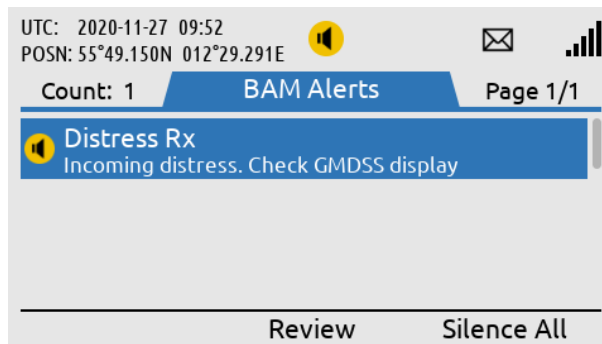

By long press on the MENU button, the BAM alerts will be shown, which in this example shows reception of a Distress Alert Relay (incoming distress).

Figure 106: Distress Alert Relay (2 of 6)

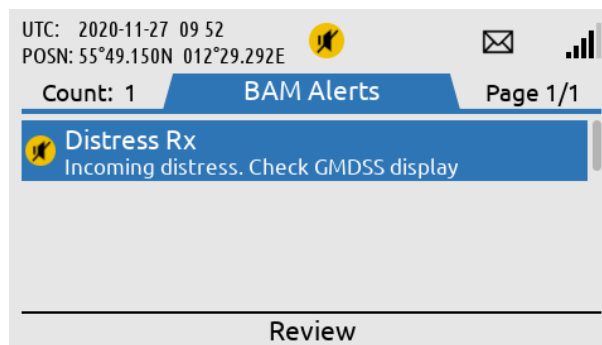

By pressing the soft key 'Silence All', the BAM alert audible will be silent for 30 seconds, hereafter resumed.

Figure 107: Distress Alert Relay (3 of 6)



Back to the default window. By pressing the soft key 'MSI (1)' the user will be directed to the MSI window (1 unread MSI message).

Figure 108: Distress Alert Relay (4 of 6)

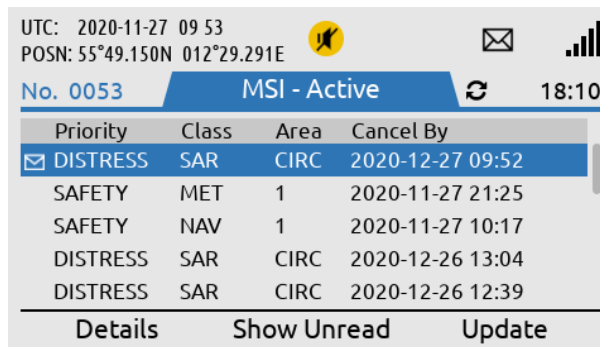

The MSI message is a Distress Alert Relay message, Class SAR (Search and Rescue). The MSI message can be read by pressing the soft key 'Details'.

Figure 109: Distress Alert Relay (5 of 6)

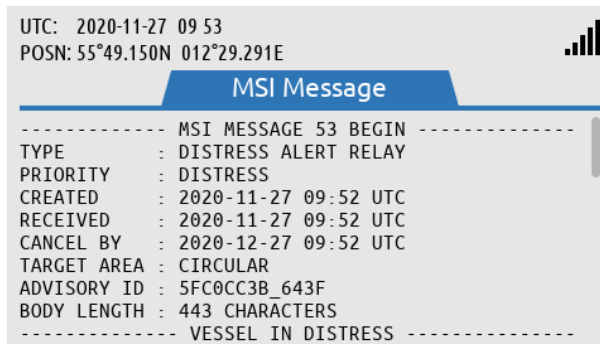

The Distress Alert Relay message has some attribute information listed in the beginning. Use the Navigation key to scroll down and read the body of the message.

Figure 110: Distress Alert Relay (6 of 6)

The LT-3100S GMDSS system will generate visual and audio notifications, when a Distress Alert Relay message is received. The Distress Relay message will generate a BAM warning, which can be viewed by long press the MENU button for more > 1 s. As illustrated in Figure 106 and Figure 107, the BAM warning can be muted for 30 seconds via the soft key 'Silence All'. By pressing the soft key 'Review', you will be directed to the MSI Messages. The BAM warning cannot be acknowledged, and the visual and audio notification will only disappear, when the Distress Alert Relay message has been read in the MSI Messages.

**NOTE:** By pushing the soft key MSI (1) you will be directed to the MSI Messages inbox from where the Distress Alert Relay message can be selected and read.

A Distress Alert Relay message received by the LT-3100S GMDSS system is illustrated in Figure 111.

```

----- MSI MESSAGE 53 BEGIN -----
TYPE           : DISTRESS ALERT RELAY
PRIORITY       : DISTRESS
CREATED        : 2020-11-27 09:52 UTC
RECEIVED       : 2020-11-27 09:52 UTC
CANCEL BY      : 2020-12-27 09:52 UTC
TARGET AREA    : CIRCULAR
ADVISORY ID    : 5FCOCC3B_643F
BODY LENGTH    : 443 Characters
-----VESSEL IN DISTRESS-----
DISTRESS       : ACTIVE
POSN           : 55-45.634N 012-36.213E
TIME OF POSN   : 2020-11-27 09:49 UTC
MMSI          : 219022390
NAME           : ARIZONA
-----MESSAGE BODY-----
DISTRESS ALERT: IRIDIUM
DISTRESS MESSAGE RECEIVED VIA IRIDIUM
VESSEL MMSI: 219022390
VESSEL NAME: Arizona
SES: SES1
DEVICE MSISDN: 881641700113
DISTRESS TYPE: undesignated distress
MESSAGE DATE: 2020-11-27
MESSAGE TIME: 09:49 UTC
MESSAGE TYPE: NEW
LATITUDE: 55.76057N
LONGITUDE: 12.60355E
POSITION RECORDED: 2020-11-27 09:49 UTC
POSITION TYPE: AUTOMATIC
POSITION UPDATED LAST 24 HRS: YES
HEADING: 12
SPEED: 0.0 KTS
RECEIVING GATEWAY: ARIZONA
<Optional text inserted by the RCC>
----- MSI MESSAGE 53 END -----

```

Figure 111: Distress Alert Relay (example)

**IMPORTANT:** A Distress Alert Relay message contains vital information about the vessel in Distress: Name, MMSI, Position, Nature of Distress, and MSISDN (if the Distress Alert message is initiated from an Iridium terminal). An example of a Distress Alert Relay message is illustrated in Figure 111. If your vessel is not being contacted directly by an RCC, after you have received a Distress Alert Relay message, then get back to the RCC and offer your assistance.



**Maritime Safety Information (MSI)**

Maritime Safety Information (MSI) is information sent by different maritime authorities to radio and satellite equipment on-board SOLAS vessels. The information can vary from weather forecast, navigation relevant information, reception of Distress Alert Relay, to SAR coordination information. The different maritime authorities providing the MSI messages are listed here:

- NAVAREA Coordinator (MSI Provider)
- METAREA Coordinator (MSI Provider)
- Rescue Coordination Center (SAR)

and further details describing the different MSI messages are showed in Table 31.

Maritime Safety Information (MSI) Supported by the IGS				
Message Type	Class	Authority	Geography	Priority
Navigational warning or bulletin	NAV	MSI Provider	Rectangular Circular NAVAREA COASTAL	Safety Urgency
Meteorological warning or forecast	MET	MSI Provider	Rectangular Circular METAREA COASTAL	Safety Urgency
Urgency & Safety Traffic	NAV SAR	MSI Provider RCC	NAVAREA	Safety Urgency
Shore to Ship Distress Alert Relay	SAR	RCC	Rectangular Circular	Distress
SAR Coordination Traffic	SAR	RCC	Rectangular Circular	Safety Urgency Distress
Piracy Situation Report	NAV (Piracy)	MSI Provider	Rectangular Circular NAVAREA COASTAL	Safety
Piracy Attack Warning	NAV (Piracy)	MSI Provider	Rectangular Circular NAVAREA COASTAL	Urgency

Table 31: Maritime Safety Information (MSI) supported by the Iridium GMDSS System (IGS)

**NOTE:** MSI message can be sent with the priorities: Distress, Urgency, or Safety. MSI message with priority: Distress, will be scheduled with immediately delivery. MSI message with priority: Urgency, will be scheduled with immediate or scheduled delivery. MSI message with priority: Safety, will be scheduled with scheduled delivery. Scheduled delivery is configured between two and four times a day, depending on the NAVAREA / METAREA. The scheduled delivery time is available in the MSI schedule and illustrated in Figure 113 on page 81.

The LT-3100S GMDSS system will always receive MSI messages from the current NAVAREA / METAREA and Coastal Warning Area, in which the LT-3100S GMDSS system is located. It is possible to configure the system, e.g. to receive MSI messages from other NAVAREA / METAREA and Coastal Warning Areas. MSI Settings are described in *MSI Settings* on page 98.

The figures, Figure 112 to Figure 115, illustrates how to read an MSI message. In this example the MSI message is a Navigational warning or forecast, sent from NAVAREA 1 (United Kingdom) with priority: Safety. The MSI message has been sent with scheduled delivery and received by the LT-3100S GMDSS system 2020-11-30 09:53 (UTC), see Figure 114 on page 82.



Figure 112: MSI Message (1 of 4)

The LT-3100S GMDSS system default window. When unread MSI messages are available, the soft key 'MSI' will change to 'MSI (X)', where X is the number of unread messages.

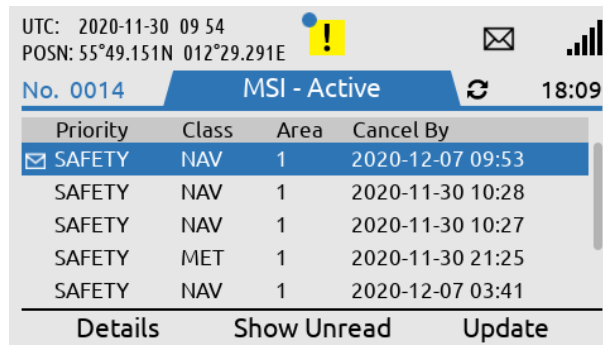

Figure 113: MSI Message (2 of 4)

The MSI window will show Priority, Class, Area, and time of cancellation for the MSI messages. Read the MSI message by pressing soft 'Details'.

**NOTE:** If there are any unread MSI messages available in the LT-3100S GMDSS system, then soft key 'MSI' will be changed to 'MSI(X)', where X is the number of unread MSI messages. Depending on the priority of the unread MSI messages available, BAM will generate an active caution or active - unacknowledged warning.

**IMPORTANT:** All MSI messages received by the LT-3100S GMDSS system must be read as soon as practically possible. It is not acceptable to have unread MSI messages available in the system.

MSI messages can contain up to 15 KB. Figure 114 illustrates that the size of this Navigational MSI message is of 2202 Bytes. Standard characters use 1 Byte, where special characters uses > 1 Byte.

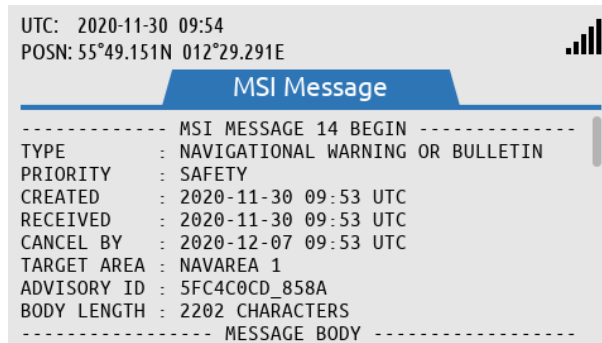

The MSI message has some attribute information listed in the beginning. Use the Navigation key to scroll down and read the body of message.

Figure 114: MSI Message (3 of 4)

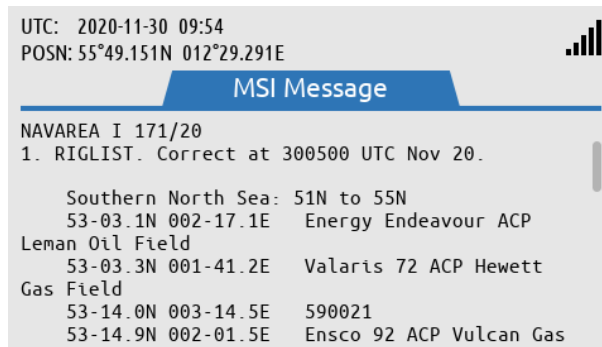

Body of the MSI message. Scroll down to read the entire MSI message.

Figure 115: MSI Message (4 of 4)

If the MSI message obtains more space than a window, then a scroll bar will be available in the right side of the MSI message window, as shown on the figures above.

Coastal Warning / Subject Indicators

MSI messages (type: Coastal Warnings), will be related to a specific Coastal Warning Area (A - Z), e.g. 10-A, where A is the Coastal Warning Area, belonging to NAVAREA 10. One or more Coastal Warning Areas can be configured in the MSI Settings, Coastal Warning Areas. The Coastal Warnings will provide information, which is subcategories in Subject Indicators (SI). The Subject Indicators are listed in Table 32. The configuration of the Subject Indicators is described in *MSI Settings* starting on page 98, under Coastal Warning Services. The Subject Indicators are also referred as Coastal Warning Services. Be aware, that some of the Subject Indicators can be configured, others are mandatory.

SI	Description	SI	Description
A	Navigational warnings	H	LORAN messages
B	Meteorological warnings	I	Not used
C	Ice Reports	J	SATNAV messages
D	Search and rescue information, and acts of piracy warnings	K	Other electronic navaid messages
E	Meteorological forecast	L	Other navigational warnings
F	Pilot service messages	V, W, X, Y	Special service allocation by the International SafetyNET panel
G	AIS	Z	No messages on hand

*Table 32: MSI Messages (coastal warning / subject indicators (SI))*

**NOTE:** By default, the LT-3100S GMDSS system will only receive Coastal Warnings from the Coastal Warning Area, in which the system is located, and only mandatory Subject Indicators are received. If the user of the LT-3100S GMDSS system would like to receive Coastal Warnings from additional Coastal Warning Areas, including non-mandatory Subject Indicators, then configuration in MSI Settings is required.

**Safety Calling**

Safety Calling is a GMDSS voice service supported between the LT-3100S GMDSS system and the Rescue Coordination Center (RCC). Safety Calling is not supported between two LT-3100S GMDSS systems. Safety Calling can be originated in both directions: 1) Mobile Originated (to RCC) and 2) Mobile Terminated (from RCC). Safety Calling is supported with priority: Distress, Urgency, and Safety.

**IMPORTANT:** Safety Calling (priority: Distress, also mentioned as Distress Call) can only be activated, if Distress has been activated by using the DISTRESS button. The section will focus on Safety Calling (priority: Urgency or Safety). Distress Call is described in *Distress Alert & Distress Call* on page 71.

Mobile Originated (to RCC)

A Safety Call to an RCC can be activated in two ways:

- 1) Using soft key ‘Safety Call’ (available on the default window)
- 2) Navigate to the RCC Contacts (MENU -> GMDSS -> Safety Contacts)

**NOTE:** It is possible to make a Safety Call to all RCCs supported by Iridium. Using the soft key ‘Safety Call’ on the default window, will initiate a Safety Call to the RCC configured in Distress Settings, Distress RCC. If the user of the LT-3100S GMDSS system navigates to MENU -> GMDSS -> Safety Contacts, then all RCCs supported by Iridium can be chosen. Safety Contacts is described in *Safety Contacts* on page 94.

The following figures, Figure 116 to Figure 119, illustrates how the user of the LT-3100S GMDSS system initiates a Safety Call (priority: Urgency) to an RCC configured in Distress Settings, Distress RCC (Automatic or Manual mode).

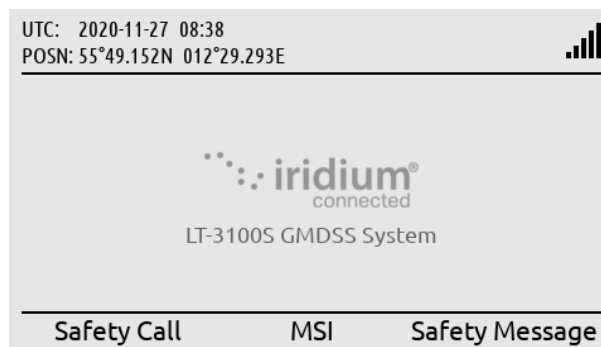

LT-3110S Control Unit, default window. A Safety Call can be initiated by using the soft key ‘Safety Call’.

Figure 116: Safety Call to RCC (1 of 4)

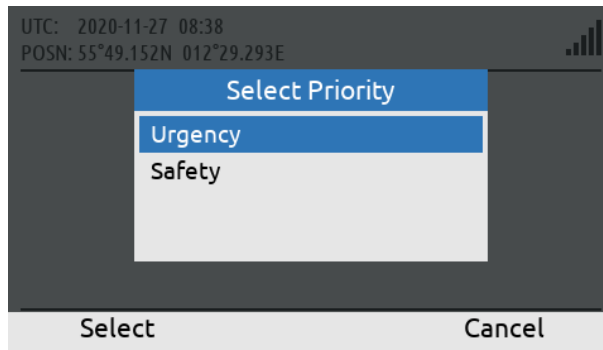

Select priority: Urgency or Safety by using the Navigation key (arrows). Hereafter use the soft key 'Select'.

Figure 117: Safety Call to RCC (2 of 4)

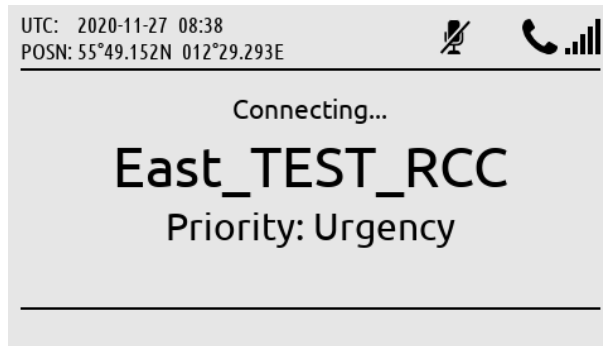

The Safety Call is connecting to the RCC (in this example East\_TEST\_RCC).

Figure 118: Safety Call to RCC (3 of 4)

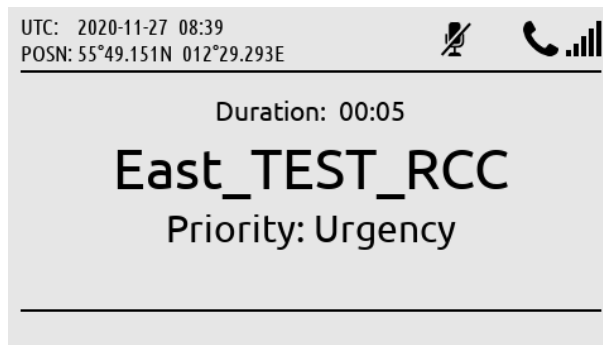

The Safety Call is connected (duration counter will start to count when the RCC has been connected).

Figure 119: Safety Call to RCC (4 of 4)

During a Safety Call, the RCC name and the priority of the call, are both presented in the call window. As soon as the Safety Call is connected to the RCC, the duration counter will start to count in the call window. The handset must be off hooked to unmute the handset microphone. In Figure 119 above, the handset microphone mute symbol is illustrated, since the handset is placed in the cradle (on hooked).

**NOTE:** A Safety Call will always show the RCC name and priority in the call window. In Figure 119 above, the user of the LT-3100S GMDSS system has initiated a Safety Call to RCC East\_TEST\_RCC (priority: Urgency). The Safety Call has been established to the RCC (duration counter has started).

Mobile Terminated (from RCC)

A Safety Call from an RCC can be received with priority: Distress, Urgency, or Safety. The incoming Safety Call will show the RCC name and priority. The following figures, Figure 120 to Figure 121, illustrates the reception of an mobile terminated Safety Call from RCC (East\_TEST\_RCC), with priority: Urgency. The Safety Call can be connected by lifting the handset out of the cradle or by pressing the off-hook button on the front of the control unit.

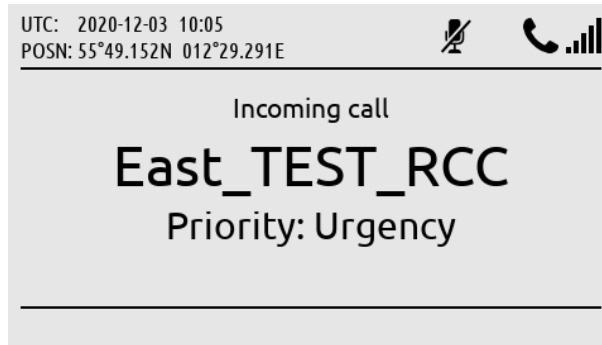

An incoming Safety Call (priority: Urgency) is calling the system. The RCC name will be displayed.

Figure 120: Safety Call from RCC (1 of 2)

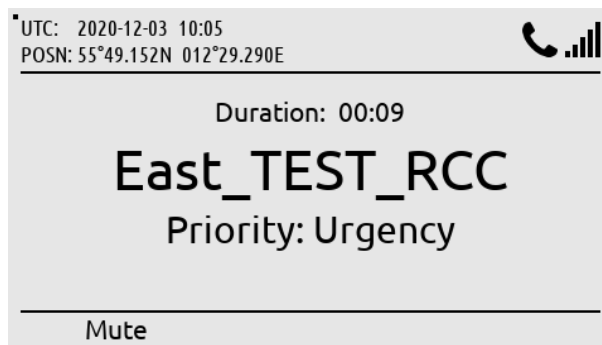

The Safety Call has been answered by lifting the handset out of the cradle.

Figure 121: Safety Call from RCC (2 of 2)

**NOTE:** When receiving a Safety Voice call from an RCC, the priority of the incoming call is shown in the call window together with the name of the RCC. In the example above, East\_TEST\_RCC has been used as a test RCC for illustration.

### Two-digit Codes

The LT-3100S GMDSS system support two-digit codes, which is handled as Safety Calling (priority = Safety). The two-digit codes with supported service by the Iridium GMDSS System (IGS) are listed in Table 33.

Two-digit Codes		
Service	Short code	Comments
Medical Advice	32	
Medical Assistance	38	
Maritime Assistance	39	
Shipment of Meteorological Data	41	Not supported by the Iridium GMDSS System (IGS).
Report Maritime Dangers	42	
Ship Report Definitions	43	Not supported by the Iridium GMDSS System (IGS).

Table 33: Two-digit Codes

The Two-digit Codes can be entered directly in the default window. Alternatively, the user can access the Safety Contacts, and select the soft key 'Show Next', where a complete list of Two-digit Codes supported by Iridium are listed (MENU -> GMDSS -> Safety Contacts). Figure 122 to Figure 125 illustrates the initiation of 'Medical Advice (32)'.

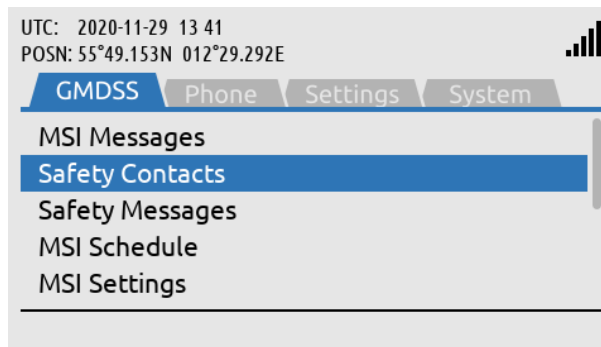

GMDSS submenu:  
Safety Contacts

Figure 122: Two-digit Codes (1 of 4)

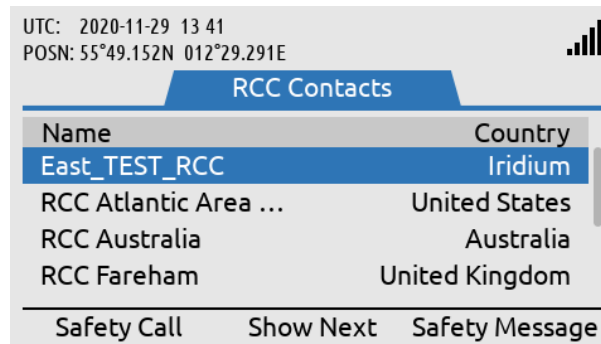

Press soft key 'Show Next' to access the Two-digit codes.

Figure 123: Two-digit Codes (2 of 4)



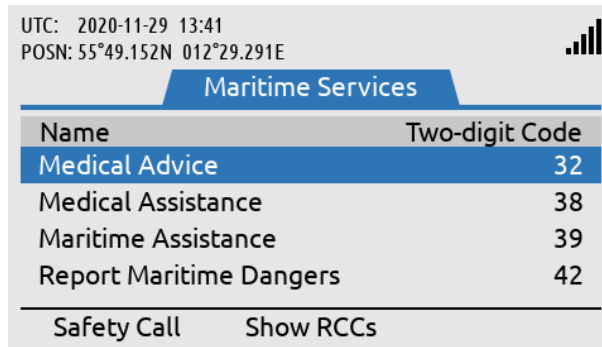

Select the Two-digit code (Maritime Service) and use the soft key 'Safety Call' to initiate the call.

Figure 124: Two-digit Codes (3 of 4)

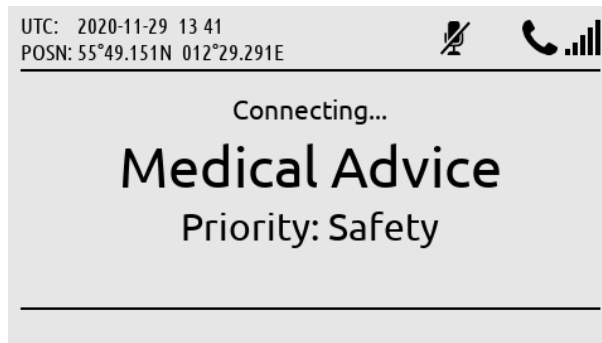

Safety Call (Medical Advice, Two-digit code: 32) being established.

Figure 125: Two-digit Codes (4 of 4)

**NOTE:** Use the LT-3110S Control Unit off-hook button or the soft key 'Safety Call' when the Two-digit Code has been selected as illustrated in Figure 124.

## Safety Messaging

Safety Messaging is a GMDSS message service supported between the LT-3100S GMDSS system and the Rescue Coordination Center (RCC). Safety Messaging is not supported between two LT-3100S GMDSS systems. Safety Messaging can be originated in both directions: 1) Mobile Originated (to RCC) and 2) Mobile Terminated (from RCC). Safety Messaging is supported with priority: Urgency and Safety.

### Mobile Originated (sending to RCC)

A Safety Message to RCC can be initiated in three ways:

- 1) Using soft key 'Safety Message' (available on the default window)
- 2) Navigate to Safety Contacts (MENU -> GMDSS -> Safety Contacts)
- 3) Navigate to Safety Messages (MENU -> GMDSS -> Safety Messages)

**NOTE:** It is possible to send a Safety Message to all RCCs supported by Iridium. Using the soft key 'Safety Message' on the default window will initiate a Safety Message to the RCC configured in Distress Settings, Distress RCC. If the user of the LT-3100S GMDSS system navigates to MENU -> GMDSS -> Safety Contacts, then all RCCs supported by Iridium can be selected. Safety Contacts is described in *Safety Contacts* on page 94.

The figures, Figure 126 to Figure 130, illustrates how the user of the LT-3100S GMDSS system initiates a Safety Message (priority: Safety) to an RCC configured in Distress Settings, Distress RCC (Automatic or Manual mode).

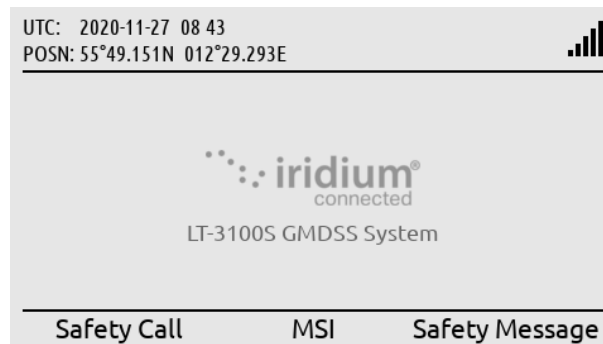

LT-3110S Control Unit, default window. A Safety Message can be initiated by pressing the soft key 'Safety Message'.

Figure 126: Safety Message to RCC (1 of 5)

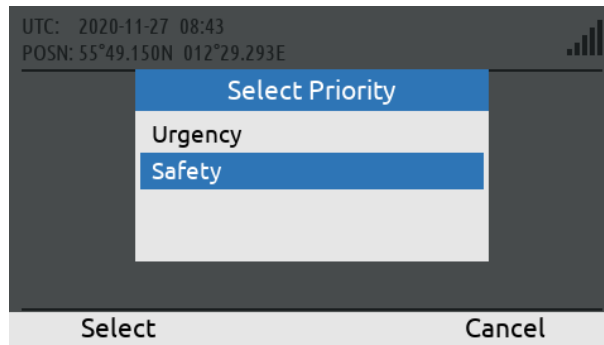

Select priority:  
Urgency or Safety.

Figure 127: Safety Message to RCC (2 of 5)

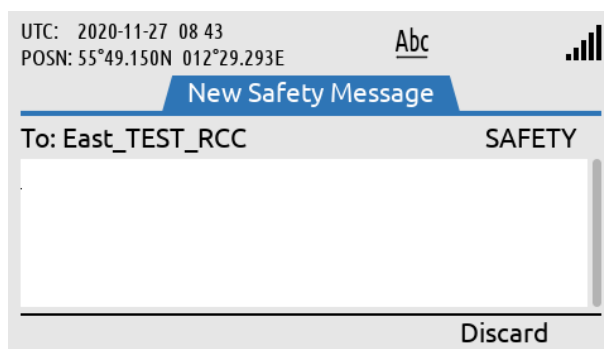

Write the body text of the Safety Message.

Figure 128: Safety Message to RCC (3 of 5)

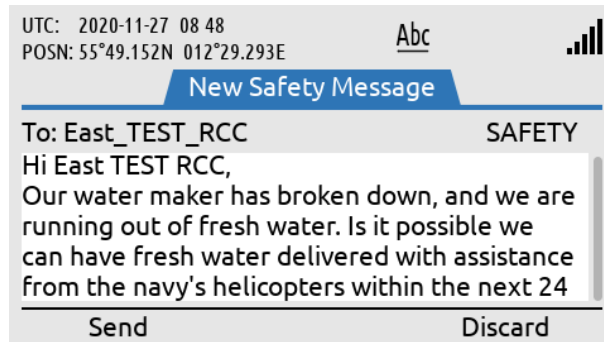

When the body text of the Safety Messages has been completed, then select soft key 'Send' and the Safety Message will be sent.

Figure 129: Safety Message to RCC (4 of 5)



The sending status of the Safety Messages will change from: Sending to Sent (re-try will be possible, if needed).

Figure 130: Safety Message to RCC (5 of 5)

After the safety Message has been written the soft key 'Send' must be applied. The User of the LT-3100S GMDSS system will now see a window with all Safety Messages, with status information about the current transmission state: Sending, Sent or Failed. In Figure 130 on page 90 the Safety Message status is showing 'Sending', which means that the Safety Message has not been sent yet. As soon as the safety message has been sent from the LT-3100S GMDSS system, the status will change to from 'Sending' to 'Sent'.

**NOTE:** All Safety Messages received in the LT-3100S GMDSS system will be available in the Safety Messages (MENU -> GMDSS -> Safety Messages). It is possible to send Safety Messages up to 1000 characters.

Mobile Terminated (received from RCC)

A Safety Message from an RCC can be received with priority: Distress, Urgency, or Safety. An incoming Safety Message will be shown with the soft key Safety 'Msgs (1)' and with a BAM symbol in the status bar. A Safety Message with priority: Safety, will be indicated with the BAM active caution symbol. The figures, Figure 131 to Figure 135, illustrates the reception of an incoming Safety Message from East\_TEST\_RCC (priority: Safety).

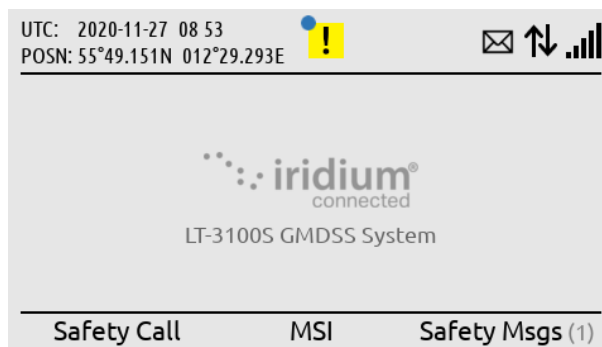

LT-3110S Control Unit, default window. A Safety Message (priority: Safety) is received. The Safety Message can be read by using the soft key 'Safety Msgs (1)'.

Figure 131: Safety Message from RCC (1 of 5)

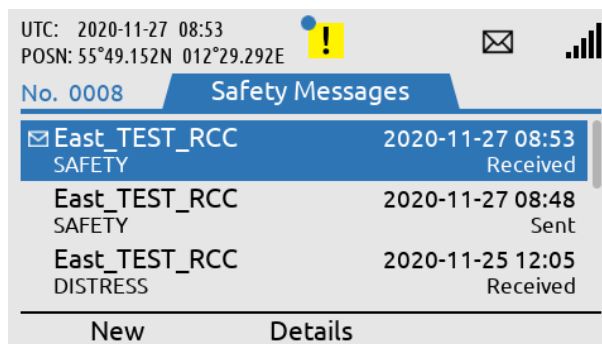

Read the Safety Message by pressing the ENTER button or use the soft key 'Details'.

Figure 132: Safety Message from RCC (2 of 5)

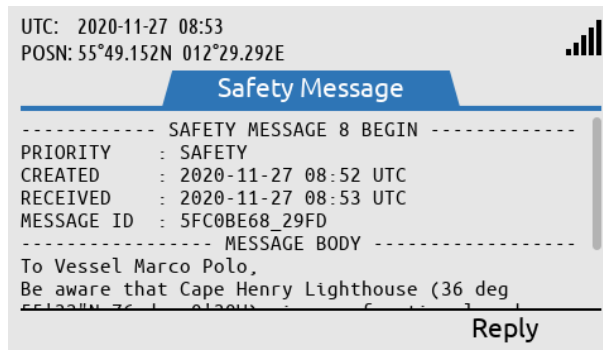

The Safety Message is now opened. The Safety Message contains a header and a message body.

Figure 133: Safety Message from RCC (3 of 5)

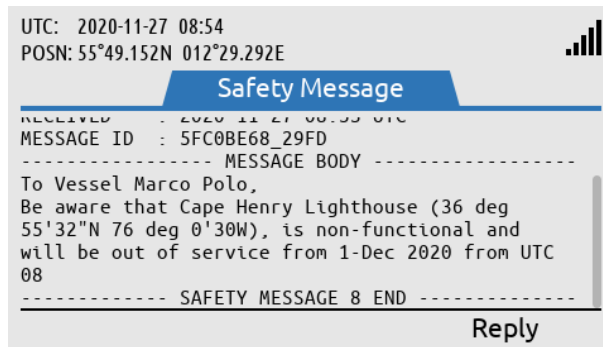

Use the Navigation key (arrow up/down) to read the entire Safety Message.

Figure 134: Safety Message from RCC (4 of 5)



After the Safety Message has been opened (and read) the unread symbol and BAM alert will be removed.

Figure 135: Safety Message from RCC (5 of 5)

**NOTE:** All Safety Messages received in the LT-3100S GMDSS system will be available in the Safety Messages (MENU -> GMDSS -> Safety Messages). It is possible to receive Safety Messages consisting of up to 1000 characters (equivalent to 1000 letters).

## GMDSS Submenu

This section will describe all relevant GMDSS settings and configurations. Some of the GMDSS submenus will only contain information/status about the LT-3100S GMDSS system.

The GMDSS submenu has the following menu path: MENU -> GMDSS

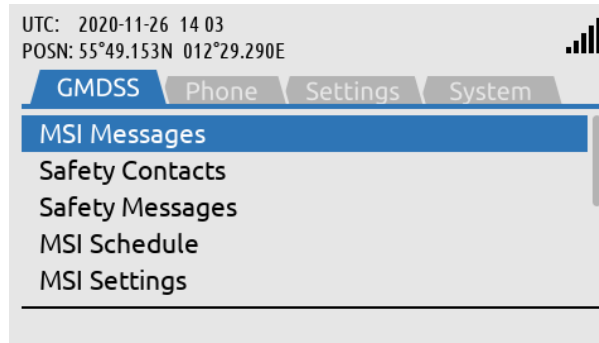

GMDSS submenu:  
MENU -> GMDSS

Figure 136: GMDSS submenu

The GMDSS submenu has the following entries:

- MSI Messages (see *Maritime Safety Information (MSI)* on page 80)
- Safety Contacts
- Safety Messages (see *Safety Messaging* on page 89)
- MSI Schedule
- Distress Settings
- Position Settings
- Location Information
- SES Information
- Terminal Test

MSI and Safety Messages are both described in the previous section *GMDSS Services*, and therefore not further described here.

**NOTE:** The GMDSS submenu contains all relevant GMDSS information and configuration settings and provides access to all GMDSS Safety Service functions. Safety Call, MSI, and Safety Message will be available via soft keys from the LT-3110S Control Unit default window.

**Safety Contacts**

The Safety Contacts contains a list of all RCCs currently supported the Iridium GMDSS System (IGS). The Safety Contacts has the following menu path: MENU -> GMDSS -> Safety Contacts (~RCC Contacts)

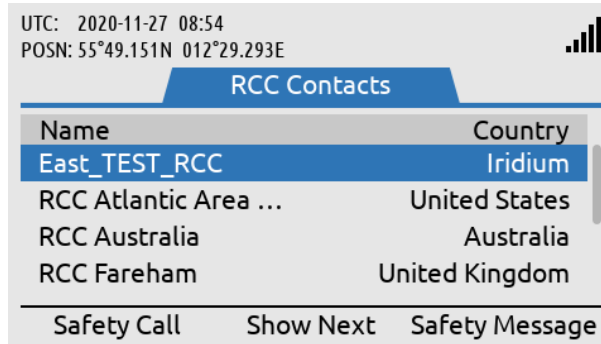

Safety Contacts  
MENU -> GMDSS -> Safety  
Contacts (~RCC Contacts)

Figure 137: GMDSS submenu (Safety Contacts)

Each of the RCC Contacts (RCCs) available in the list can be contacted via a Safety Call or a Safety Message. When entering the RCC Contacts, all RCCs can be contacted with the following priority: Safety or Urgency (the East\_TEST\_RCC will not be present on a production system).

**NOTE:** If the user of the LT-3100S GMDSS system would like to get in contact with an RCC that is different from the RCC configured in Distress Settings, Distress RCC (Automatic or Manual mode), then the user of the system must navigate to the RCC Contacts window. E.g. if the LT-3100S GMDSS system is configured to Distress RCC (Automatic mode) and the operator of the system would like to make a Safety Call to an RCC in a different Sea Area. Otherwise, the soft keys 'Safety Call' or 'Safety Message' on the default window of the LT-3110S Control Unit can be used.

Safety Call is described in further details in *Safety Calling* on page 84. Safety Messaging is described in further details in *Safety Messaging* on page 89.

**IMPORTANT:** The number of RCC supported in the Iridium GMDSS System (IGS) and available in the LT-3100S GMDSS system (RCC Contacts) will increase over time. Each and all Sea Areas will always have a responsible RCC covering a specific Sea Area. A new GMDSS configuration file will automatically and occasionally be pushed to the LT-3100S GMDSS system containing an up to date RCC list. The number of RCCs supported in the Iridium GMDSS System (IGS) is listed on the Iridium GMDSS website: <https://www.iridium.com/gmdss-launch/>

**MSI Schedule**

The LT-3100S GMDSS system support reception of MSI messages. The Maritime Safety Information (MSI) is described in *Maritime Safety Information (MSI)* on page 80. The MSI Schedule is providing an overview to the user about MSI messages: 1) from which NAV-/METAREAs and Coastal Warning Areas (CWA) the LT-3100S GMDSS system is receiving MSI messages from (default and optionally configured) and 2) at what time these MSI messages should be expected. MSI messages with high priority will typically be sent to the LT-3100S GMDSS system with no delay. The MSI Schedule is placed in the GMDSS submenu (MENU -> GMDSS -> MSI Schedule), see Figure 138 and Figure 139.

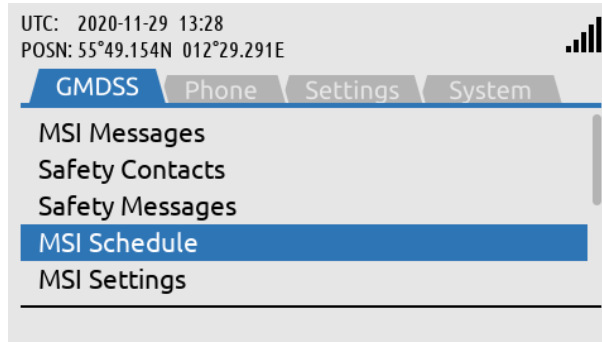

MSI Schedule:  
MENU -> GMDSS -> MSI Schedule

Figure 138: GMDSS submenu (MSI Schedule)

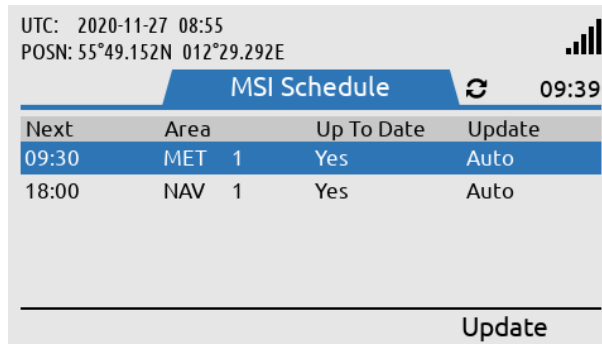

The MSI Schedule will show a list of the NAV-/METAREAs and Coastal Warning Areas receiving MSI information from.

Figure 139: GMDSS submenu (MSI Schedule)

**NOTE:** The MSI Schedule illustrated in Figure 139 shows a LT-3100S GMDSS system located in NAV-/METAREA 1 (~United Kingdom I). The entire list of NAV-/METAREAs is shown in Table 35 on page 113. The entire list of Coastal Warning Areas (CWA) is shown in Table 36 on page 114.

The column 'Next' is providing information about the next time when the LT-3100S GMDSS system will receive MSI information from the Iridium GMDSS System (IGS). This time will be offset randomly (up to XX minutes) to handle countless GMDSS terminals, therefore the 9 minutes difference, as illustrated in Figure 139. The column 'Update' is indicating Auto, which informs that the MSI retrieve will happen automatically at the time specified.



Manual Update

The user of the LT-3100S GMDSS system can always use the soft key 'Update' to check and retrieve MSI messages. The manual update function is optional and not required to use at any time. The manual update function can be used to retrieve MSI messages at an earlier time if one needs this. The use of the manual update function is illustrated in Figure 140 and Figure 141.

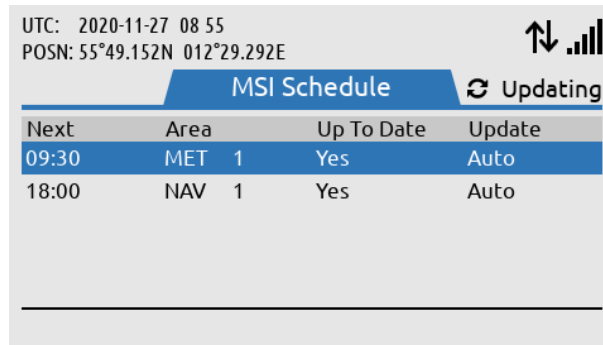

The soft key 'Update' has been used. The LT-3100S GMDSS system will check for MSI information available.

Figure 140: GMDSS submenu (MSI Schedule)

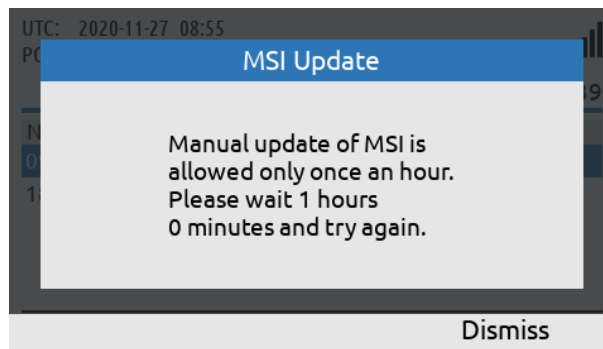

The Manual MSI Update is only allowed to be used once an hour (and user restricted).

Figure 141: GMDSS submenu (MSI Schedule)

As soon as the manual update button has been activated, the LT-3100S GMDSS system will start retrieve MSI messages from the Iridium GMDSS System (IGS). This is indicated by the updating symbol rotating and data symbol in the status bar. The user is only allowed to use the manual update button once an hour and will be restricted by a pop-up informing the user when the manual update function can be used again.

Additional NAV-/METAREA or CWA

If the user of the LT-3100S GMDSS system has configured additional NAV-/METAREAs or Coastal Warning Areas (see *MSI Settings* on page 98), then these additional areas will be listed in the MSI Schedule, see Figure 142. The column 'Update' for the additional configured NAV-/METAREAs and Coastal Warning Areas (CWA) will be indicating Manual. The MSI messages from areas indicating Manual will be retrieved automatically at the 'Next' time from the areas indicating Auto. It is always possible to use the soft key 'Update' to check for all MSI messages valid for the LT-3100S GMDSS system configuration.

Next	Area	Up To Date	Update
09:30	MET 1	Yes	Auto
11:00	MET 19	No	Manual
18:00	NAV 1	Yes	Auto
18:30	NAV 19	No	Manual

This LT-3100S GMDSS system has been configured with NAV-/METAREA 19 (Norway) as an additional Sea Area to receive MSI information from.

Figure 142: GMDSS submenu (MSI Schedule)

**NOTE:** All NAV-/METAREAs and Coastal Warning Areas (CWA) from where the LT-3100S GMDSS system periodically will receive MSI messages from (typically NAV and MET MSI providers) will be listed in the MSI Schedule. NAV-/METAREA and Coastal Warning Area (CWA) in which the LT-3100S GMDSS system is in and nearby, will always be shown in the MSI Schedule. For NAV-/METAREAs nearby is defined as 300 NM / for Coastal Warning Areas (CWA) nearby is defined as 100 NM.

**MSI Settings**

The MSI Settings menu is handling all configuration options related to reception of Maritime Safety Information (MSI).

The MSI Settings window has the following menu path: MENU -> GMDSS -> MSI Settings

The MSI Settings has the following optional configuration items:

- NAVAREA / METAREA
- Coastal Warning Areas
- Coastal Warning Services
- Area By Fixed Position

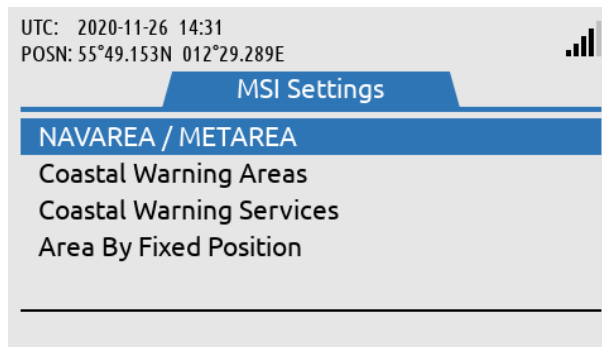

MSI Settings:  
MENU -> GMDSS -> MSI Settings

Figure 143: GMDSS submenu (MSI Settings)

**NOTE:** The LT-3100S GMDSS system will always receive the mandatory MSI information, which are relevant for the current NAV- / METAREA and Coastal Warning Area, in which the terminal is located and nearby.

NAVAREA / METAREA

The LT-3100S GMDSS system can be configured to receive MSI information from NAVAREA / METAREAs, in which the terminal is not located. The following figures, Figure 144 to Figure 147, illustrates how to add NAVAREA / METAREAs in order to receive MSI information from these areas.

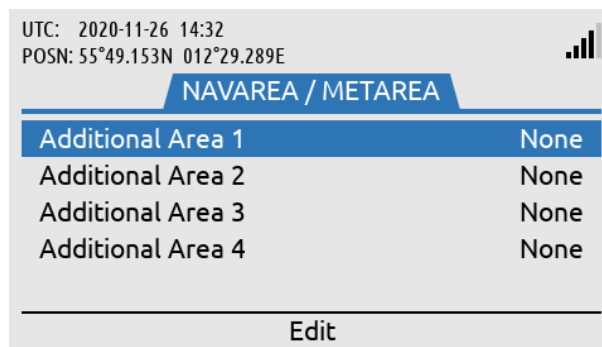

In the NAVAREA / METAREA additional Sea Areas can be added to receive MSI information from (up to 4).

Figure 144: MSI Settings, NAV-/METAREA (1 of 4)

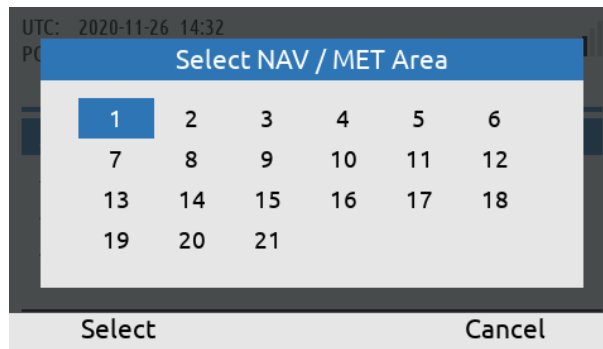

Select the NAV / MET Area to be added to the configuration.

Figure 145: MSI Settings, NAV-/METAREA (2 of 4)

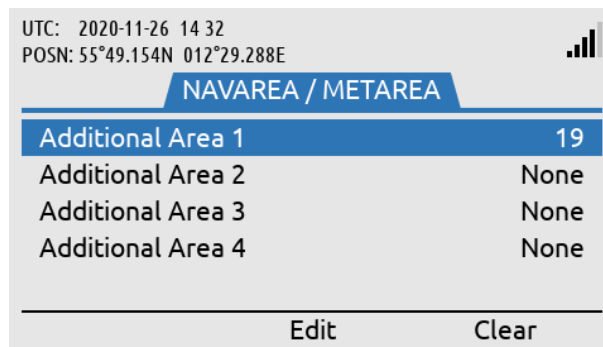

NAV-/METAREA 19 (Norway) has been added to the configuration list.

Figure 146: MSI Settings, NAV-/METAREA (3 of 4)

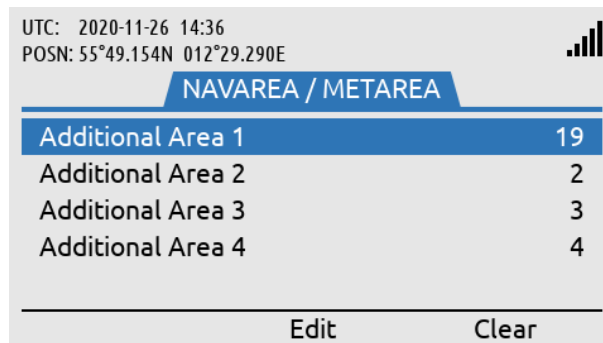

Up to 4 additional NAV / MET Areas can be added to the configuration list.

Figure 147: MSI Settings, NAV-/METAREA (4 of 4)

**NOTE:** It is possible to add up to four additional Sea Areas, from which you would like to receive MSI information from. The current Sea Area, in which you are currently located, can be added as one of the four additional Sea Areas. You will always receive MSI information from the Sea Area, in which you are currently located. In order to identify the sea area, in which you are currently located, see *Location Information* on page 112.

Coastal Warning Areas

The LT-3100S GMDSS system can be configured to receive MSI information from Coastal Warning Areas, in which the terminal is not located. The MSI Settings configuration of the Coastal Warning Areas in this section has no impact on the MSI Settings configuration of the NAVAREA / METAREA in the previous section. Both MSI Settings will add geographical areas to the current Sea Area (and maybe Coastal Warning Area), in which the terminal is in and nearby, and will by default receive MSI Information from. The number of Coastal Warning Areas represented in each Sea Area is very different and can vary from 0 to A - Z.

The following figures, Figure 148 to Figure 152, illustrates how to add Coastal Warning Areas in order to receive MSI information from these areas.

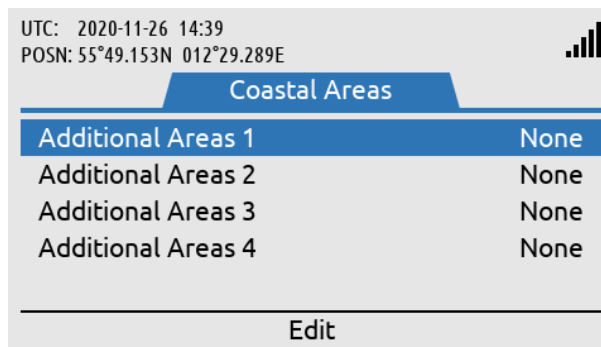

Coastal Warning Areas:  
MENU -> GMDSS -> MSI  
Settings -> Coastal Warning  
Areas

Figure 148: MSI Settings, Coastal Warning Areas (1 of 5)



Select NAVAREA  
responsible for the Coastal  
Warning Area/-s to be  
added to the configuration  
list.

Figure 149: MSI Settings, Coastal Warning Areas (2 of 5)

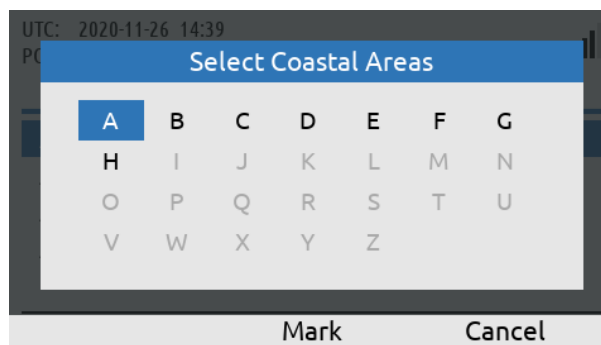

Mark Coastal Warning  
Areas to be added to the  
configuration list (can  
individually be marked or  
not).

Figure 150: MSI Settings, Coastal Warning Areas (3 of 5)

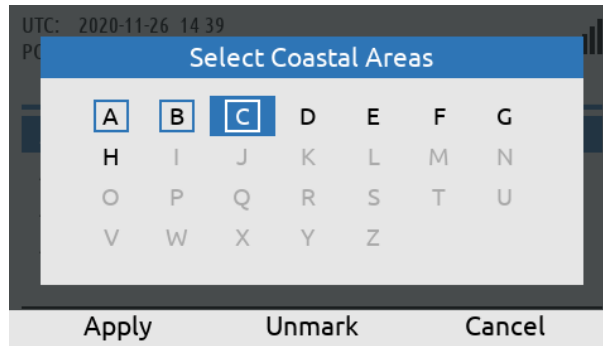

On-going marking of the Coastal Warning Areas to be added. Use the soft key 'Apply' when completed.

Figure 151: MSI Settings, Coastal Warning Areas (4 of 5)

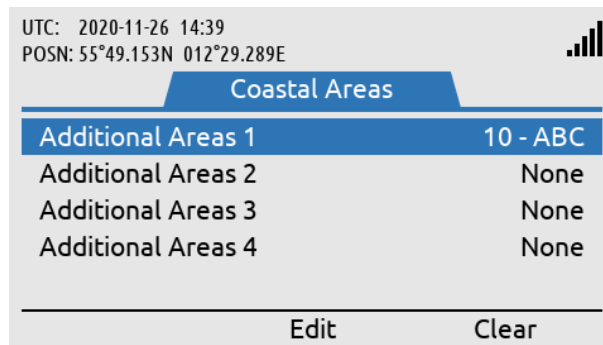

Coastal Warning Areas: A, B, and C in NAVAREA 10 has been added to the list of areas, in which the system will now receive MSI information from.

Figure 152: MSI Settings, Coastal Warning Areas (5 of 5)

In the MSI Settings configuration of the Coastal Warning Areas, as illustrated in Figure 152 above, it is only the Coastal Warning Areas: A, B and C (located in NAVAREA 10) which are added to the MSI reception. If the user of the LT-3100S GMDSS system would like to receive MSI messages from NAVAREA / METAREA 10, then make sure to add this Sea Area in the MSI Settings as described in NAVAREA / METAREA and as illustrated in Figure 144 on page 98.

**NOTE:** It is possible to add up to four additional NAVAREA / Coastal Warning Areas (A-Z), in which you would like to receive MSI information from. The current Coastal Warning Area, in which you are currently in, can be added as one of the four additional Coastal Warning Areas (A-Z). You will always receive MSI information from the Coastal Warning Area, in which you are currently in (if located in a Coastal Warning Area). In order to identify the Coastal Warning Area, in which you are currently located, see *Location Information* on page 112.

**NOTE:** It is only possible to configure up to 5 Coastal Warning Areas for a given NAVAREA.

Coastal Warning Services

The Coastal Warning Area in which you are located and the Coastal Warning Areas that you have configured optionally have some mandatory and optionally services. The Coastal Area Services applied will be valid for all Coastal Warning Areas watched. The Coastal Warning Services are illustrated in Figure 153 and the complete list of services are available in Table 34.

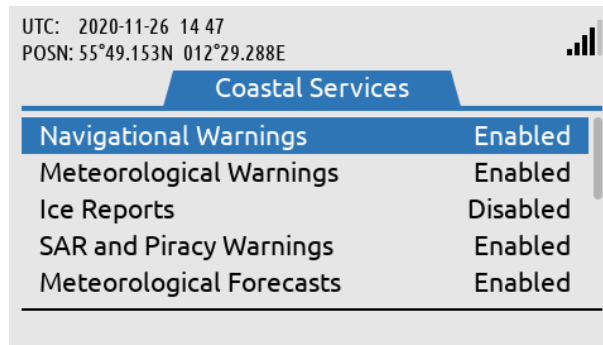

Coastal Warning Services:  
MENU -> GMDSS -> MSI  
Settings -> Coastal  
Warning Services

Figure 153: MSI Settings, Coastal Warning Services (1 of 2)

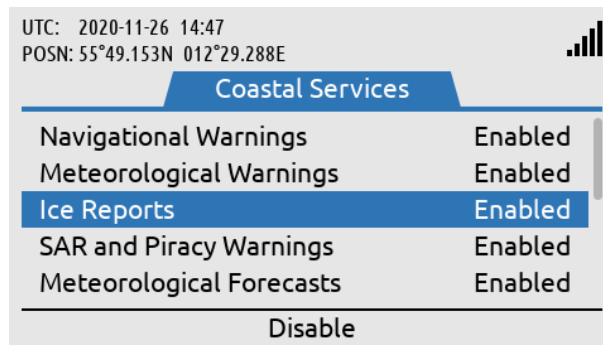

Enabling of Ice Reports  
for all Coastal Warning  
Areas illustrated.

Figure 154: MSI Settings, Coastal Warning Services (2 of 2)

Coastal Warning Services		
Service	Default Settings	User Configurable
Navigational Warnings	Enabled	No
Meteorological Warnings	Enabled	No
Ice Reports	Disabled	Yes
SAR and Piracy Warnings	Enabled	No
Meteorological Forecasts	Enabled	No
Pilot Service Messages	Disabled	Yes
AIS	Disabled	Yes
LORAN Messages	Disabled	Yes
SATNAV Messages	Disabled	Yes
Other Nav aids Messages	Disabled	Yes
Additional NAV Warnings	Disabled	Yes

Table 34: MSI Settings, Coastal Warning Services

**NOTE:** In Figure 154 it is illustrated that Ice Reports has been enabled for Coastal Warning Areas. This setting will apply to all Coastal Warning Areas watched.

Area By Fixed Position

As an alternative to configure MSI Settings for NAVAREA / METAREA and Coastal Warning Areas, Area By Fixed Position can be configured for receiving MSI information from a predefined position of interest. The user of the LT-3100S GMDSS system can configure a static position (latitude / longitude) with a fixed radius of 300 NM. All NAVAREA / METAREA and Coastal Warning Areas intercepted and included in this fixed circle will be added to the list of Sea Areas Sea Areas, in which the terminal will receive MSI information from.

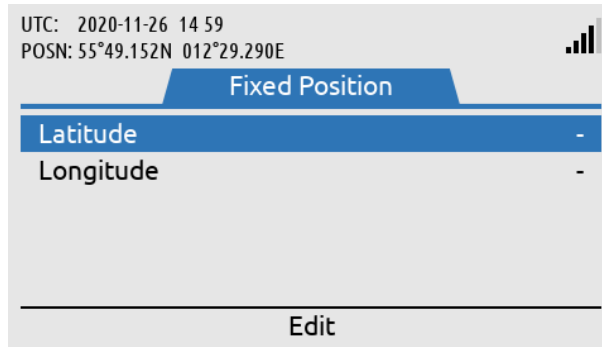

Area By Fixed Position:  
MENU -> GMDSS -> MSI  
Settings -> Area By Fixed  
Position

Figure 155: MSI Settings, Area By Fixed Position (1 of 3)

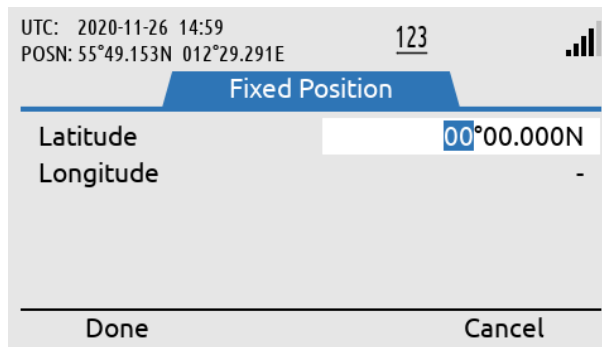

Inserting position (latitude  
and longitude) in order to  
receive MSI information  
from this point of interest.

Figure 156: MSI Settings, Area By Fixed Position (2 of 3)

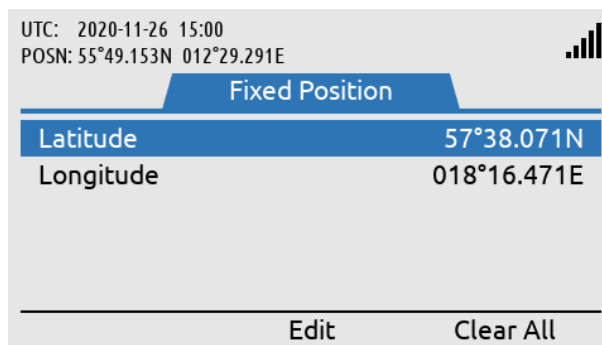

Position inserted and  
Area By Fixed Position  
activated.

Figure 157: MSI Settings, Area Fixed By Position (3 of 3)

**NOTE:** MSI Settings Area By Fixed Position is an alternative to configure NAVAREA / METAREA and Coastal Warning Areas in order to receive MSI information from a predefined position of interest.



### Distress Settings

The LT-3100S GMDSS system has a submenu from where all relevant Distress Settings can be configured. The Distress Settings window has the following menu path: MENU -> GMDSS -> Distress Settings

The Distress Settings window consist of the following configuration items:

- Distress RCC
- Auto-dial
- Nature of Distress

The configuration items will be further described in the next sections.

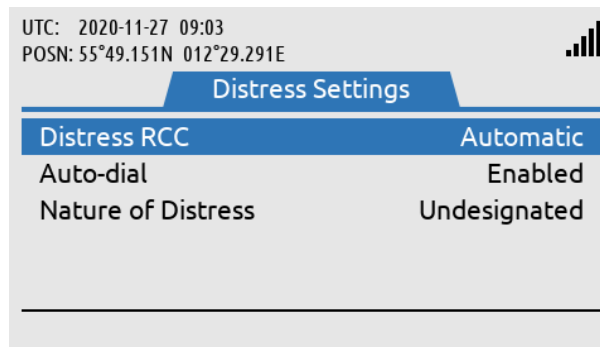

Distress Settings:  
MENU -> GMDSS ->  
Distress Settings

Figure 158: GMDSS submenu (Distress Settings)

### Distress RCC

The Distress Settings, Distress RCC can be configured to the following options:

- Automatic
- Manual

The Distress RCC recommended setting is Automatic. The Distress RCC has been configured during completion of the Installation Wizard, see *Installation Wizard* on page 57. In Automatic mode the Distress Alert, Distress Call, Safety Calling and Safety Messaging (Distress, Urgency, or Safety) will be routed to the RCC responsible for the Sea Area, in which the vessel is located. In Distress RCC Manual mode the specific RCC selected will be used for routing the Distress Alert, Distress Call, Safety Calling and Safety Messaging (Distress, Urgency, or Safety) regardless of where the vessel is located.

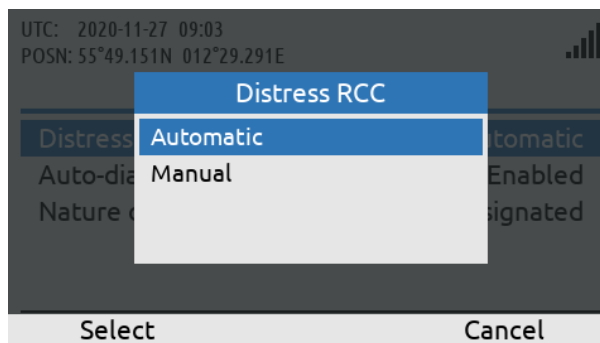

Use the Navigation key to select Automatic or Manual RCC.

Figure 159: Distress Settings, Distress RCC (1 of 3)

**NOTE:** The user of the LT-3100S GMDSS system can always enter the Distress Settings, RCC Settings and change the setting of the Distress RCC between Automatic and Manual mode.

The following figures, Figure 160 and Figure 161, illustrates how the user of the LT-3100S GMDSS system can change Distress RCC from Automatic to Manual mode. In Manual mode the specific Distress RCC selected will be displayed in the Distress Settings window. In this example: East\_TEST\_RCC has been configured.

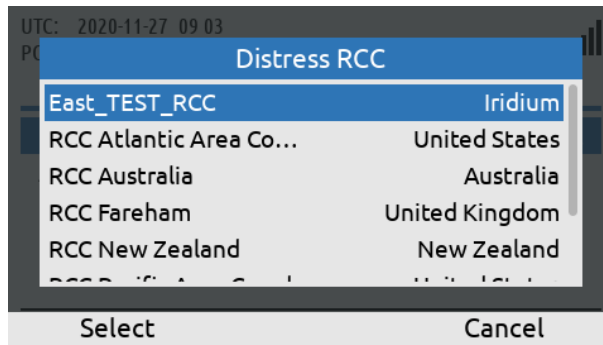

If Distress RCC, Manual has been selected, then the user of the LT-3100S GMDSS system can select an RCC from a list.

Figure 160: Distress Settings, Distress RCC (2 of 3)

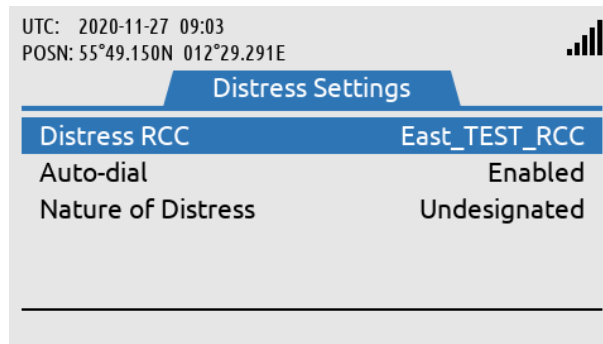

The Manual RCC selected will be shown in Distress Settings with its RCC name.

Figure 161: Distress Settings, Distress RCC (3 of 3)

**NOTE:** During completion of the Installation Wizard and whenever there are changes to the GMDSS configuration file received from the Iridium GMDSS System (IGS), the LT-3100S GMDSS system will get the latest version of the GMDSS configuration file, which may contain changes to e.g. the RCC Contacts. The user of the LT-3100S GMDSS system should expect that Iridium will add new RCCs frequently after introducing the Iridium GMDSS Service.

Auto-dial

The Distress Settings, Auto-dial can be configured to the following options:

- Enabled
- Disabled

The default setting of the Auto-dial is Enabled. It is always possible to configure the Auto-dial setting at any time after the Installation Wizard has been completed.

If the Auto-dial is configured to Enabled, then the LT-3100S GMDSS system will automatically call the RCC, if the DISTRESS button has been activated and once the Distress Alert messages has been delivered to the Iridium GMDSS System (IGS). The Distress Alert and Distress Call is described in further details in *Distress Alert & Distress Call* on page 71.

The following figures, Figure 162 and Figure 163, illustrates how the user of the LT-3100S GMDSS system can change Auto-dial from Enabled to Disabled.

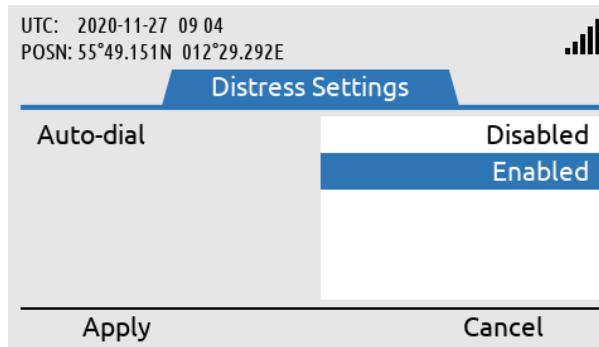

Auto-dial:  
MENU -> GMDSS -> Distress  
Settings -> Auto-dial

Figure 162: Distress Settings, Auto-dial (1 of 2)

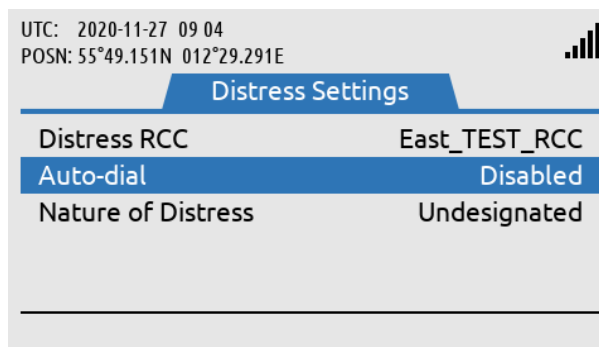

Auto-dial configured to  
Disabled (the LT-3100S  
GMDSS system will not  
automatically make a  
Distress Call to the RCC).

Figure 163: Distress Settings, Auto-dial (2 of 2)

**NOTE:** The Auto-dial configuration is by default set to Enabled, which means that the LT-3100S GMDSS system automatically will call the RCC after a Distress Alert messages has successfully been delivered to the Iridium GMDSS System (IGS), after the DISTRESS button has been pushed and held for a minimum 3 seconds.

Nature of Distress

The Distress Settings, Nature of Distress can be configured to the following options:

- Undesignated
- Fire/explosion
- Flooding
- Collision
- Grounding
- Listing
- Sinking
- Disabled and adrift
- Abandoning ship
- Piracy/armed attack
- Man overboard

There are two methods of configuring Nature of Distress when the user of the LT-3100S GMDSS system is sending a Distress Alert message to the RCC:

- 1) When the DISTRESS button has been activated an initial Distress Alert message will be sent to the RCC (Nature of Distress = Undesignated). Hereafter, the user of the system can use the soft key 'Select Nature', and an updated Distress Alert message will now be sent with the chosen Nature of Distress information. This method is illustrated and described in details in *Distress Alert & Distress Call* on page 71.
- 2) The user of the LT-3100S GMDSS system must navigate to MENU -> Distress Settings -> Nature of Distress and configure the Nature of Distress that must be informed to the RCC. Hereafter the operator of the system pushes the DISTRESS button and activates the Distress Alert message. The Initial Distress Alert message will contain the Nature of Distress information configured.

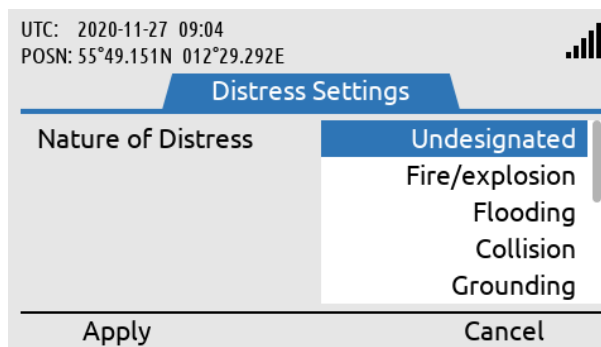

Nature of Distress:  
MENU -> GMDSS -> Distress  
Settings -> Nature of  
Distress

Figure 164: Distress Settings, Nature of Distress

**NOTE:** By default, Nature of Distress is configured to Undesignated. It is always possible to send an updated Distress Alert message to the RCC, where the Nature of Distress information is provided or changed. If Distress Settings, Nature of Distress is not configured in the LT-3100S GMDSS system, then Undesignated will be sent in the initial Distress Alert message to the RCC.

## Position Settings

The LT-3100S GMDSS system is default configured to use the built-in GNSS receiver, Automatic (GNSS) mode, for determining the current position of the vessel. The position is primarily used for:

- Distress Alert sent to the RCC upon activation of a Distress
- Location information updates sent to the Iridium GMDSS System (IGS)

In case the built-in GNSS receiver has a malfunction or if the user for some other reason (e.g. GNSS spoofing) is required to manually enter the current position of the vessel, this can be done in Position Settings (MENU -> GMDSS -> Position Settings).

The following instruction will help you change Position Settings from Automatic to Manual mode:

1. Select Source of Position and press ENTER
2. Select Manual Input and press ENTER
3. Fill in the Latitude and Longitude fields
4. Fill in the Time of Position field with the time in UTC at which the vessel was at the position entered in the Latitude and Longitude fields (*note*: This may not be the current time)
5. The Course over Ground (COG) and Sped over Ground (SOG) are optional and can be set to zero if unknown
6. When all fields have been assigned a value, press the soft key 'Apply' to apply the manual position

**NOTE:** The LT-3100S GMDSS system is by default configured to Automatic (GNSS) position mode. The manual position mode should only be used, if the Automatic (GNSS) position mode is not providing valid information.

The Position Settings illustrated in Figure 165 shows the LT-3100S GMDSS system configured to Automatic (GNSS) position mode.

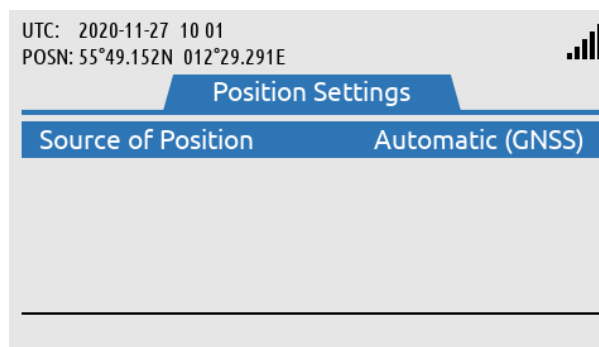

Position Settings:  
MENU -> GMDSS -> Position  
Settings

Figure 165: Position Settings, Manual Position (1 of 12)

Figure 166 to Figure 176 illustrates how the Position Settings, Source of Position is changed from Automatic (GNSS) to Manual position mode.

**NOTE:** Please be aware that, if manual position mode is set, while the LT-3100S GMDSS system has no valid position from the GNSS receiver, the system will automatically switch to automatic mode, as soon as it gets a valid position (3D fix).

Manual Position

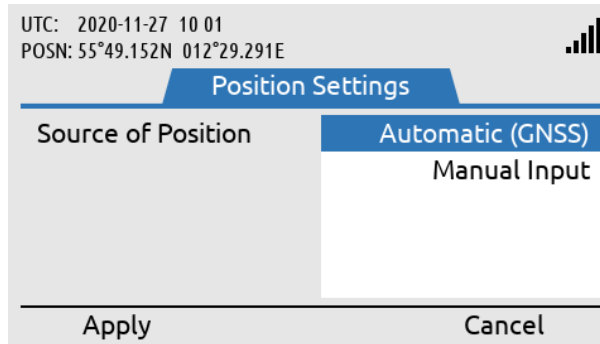

Source of Position is changed from Automatic (GNSS) to Manual Input. Use the soft key 'Apply'.

Figure 166: Position Settings, Manual Position (2 of 12)

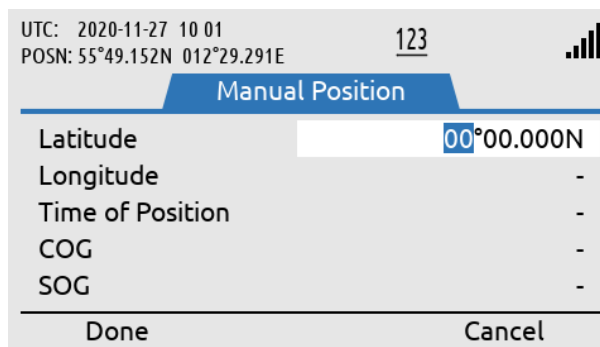

Latitude is configured. Use the soft key 'Done', when Latitude has been entered correctly.

Figure 167: Position Settings, Manual Position (3 of 12)

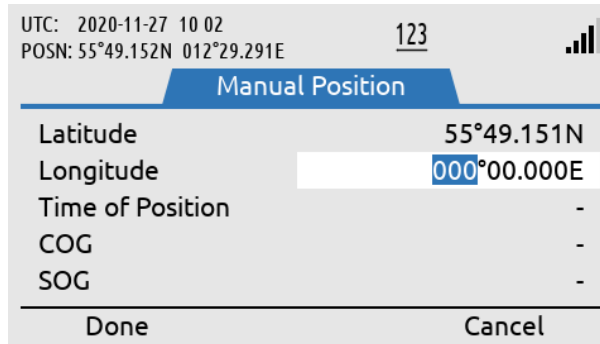

Longitude is configured. Use the soft key 'Done', when Longitude has been entered correctly.

Figure 168: Position Settings, Manual Position (4 of 12)

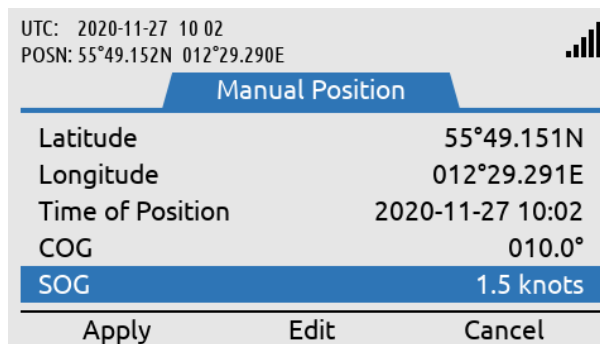

Time of Position, COG, and SOG must be entered. Use soft key 'Apply' when all inputs have been entered correctly.

Figure 169: Position Settings, Manual Position (5 of 12)

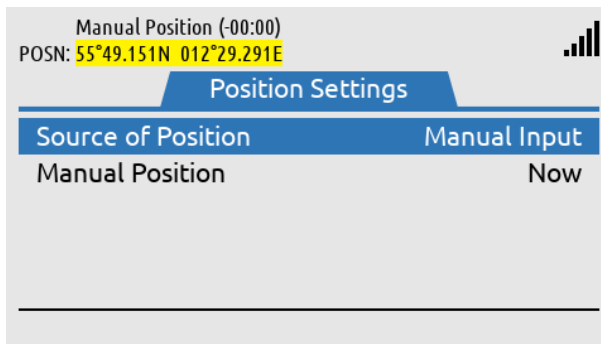

Manual Position is now being used as the position in the system. See information in the status bar (position is colored yellow to indicate low integrity).

Figure 170: Position Settings, Manual Position (6 of 12)

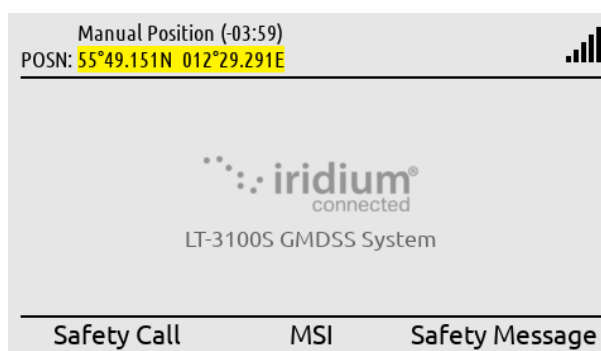

In the status bar the age of the Manual Position is shown. (-03:59) indicates that the position is three hours and 59 minutes old.

Figure 171: Position Settings, Manual Position (7 of 12)

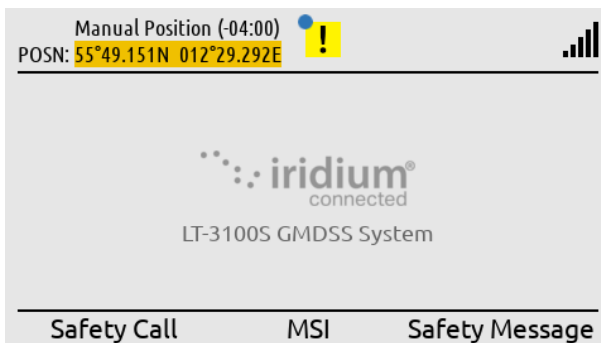

When the Manual Position is more than 4 hours old, a BAM alert caution (doubtful pos) will be raised.

Figure 172: Position Settings, Manual Position (8 of 12)

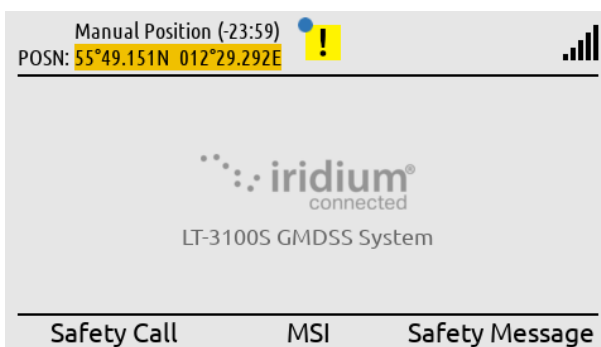

The manual position will be colored orange to indicate invalid until it has been updated.

Figure 173: Position Settings, Manual Position (9 of 12)

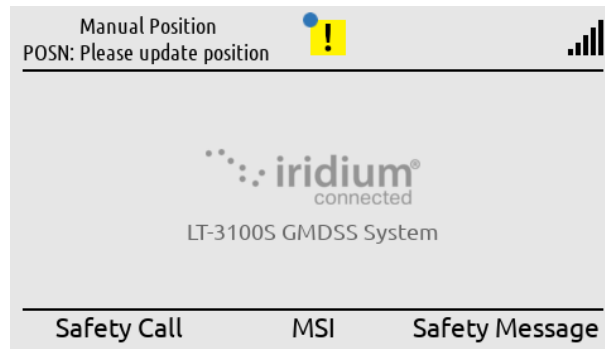

When the Manual Position is older than 24 hours the status bar will indicate “POSN: Please update position”.

Figure 174: Position Settings, Manual Position (10 of 12)

Update Manual Position

In manual position mode the position must be updated every 4 hours. A BAM alert active caution (doubtful pos) will be activated when the manual position is older than 4 hours. The position will be colored yellow to indicate low integrity when in manual position mode and colored orange when the position is older than 4 hours to indicate invalid. Make a long press on the MENU button to access the BAM Alerts. Hereafter press the soft key ‘Review’ to update the manual position.

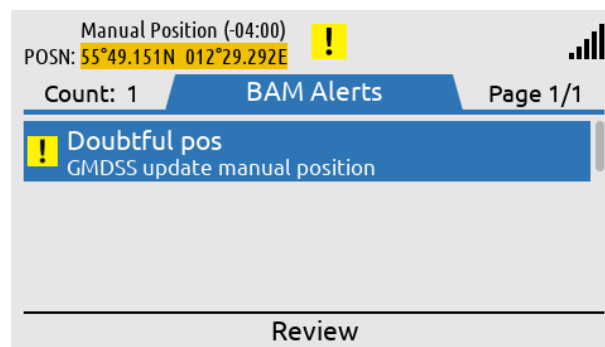

BAM alert active caution (doubtful pos) available since Manual Position is older than 4 hours.

Figure 175: Position Settings, Manual Position (11 of 12)

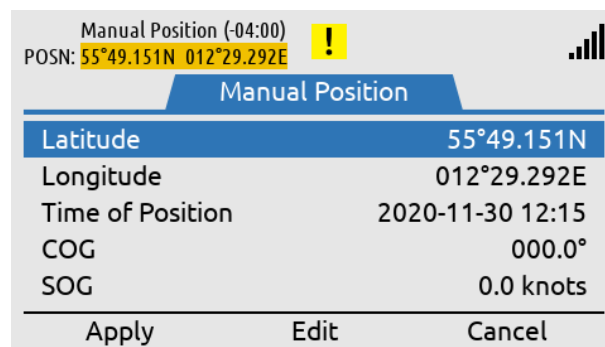

By pressing the soft key ‘Review’ it is possible to update the Manual Position.

Figure 176: Position Settings, Manual Position (12 of 12)

**NOTE:** In manual position mode the position must be updated every 4 hours. A BAM alert active caution (Doubtful pos) will be shown after 4 hours. The user of the LT-3100S GMDSS system must enter a new up-to-date position (MENU -> GMDSS -> Position Settings).



**Location Information**

The LT-3100S GMDSS system has a window, where it is possible to read out details about the Sea Area and responsible RCC, in which the terminal is located:

- NAVAREA
- METAREA
- Coastal Warning Area
- Responsible RCC

Location Information has the following menu path: MENU -> GMDSS -> Location Information

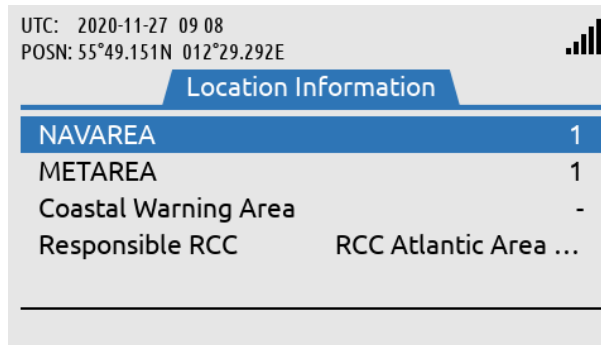

Location Information:  
MENU -> GMDSS ->  
Location Information

Figure 177: GMDSS submenu (Location Information)

**NOTE:** Location Information is read-only and is dependent on the 'Source of Position' user setting.

NAVAREA

The world is divided into 21 geographical Sea Areas identified as NAVigational AREAs (NAVAREAs) ranging from NAVAREA 1 (United Kingdom) to 21 (Russian Federation). The NAVAREAs are listed in Table 35. The NAVAREAs are used to coordinate the communication of navigational hazards to mariners.

NAVAREAs	
NAVAREA No.	Coordinator
1	United Kingdom
2	France
3	Spain
4	United States of America (East)
5	Brazil
6	Argentina
7	South Africa
8	India
9	Pakistan
10	Australia
11	Japan
12	United States of America (West)
13	Russia
14	New Zealand
15	Chile
16	Peru
17	Canada
18	Canada
19	Norway
20	Russian Federation
21	Russian Federation

*Table 35: NAVAREAs*

**NOTE:** The NAVAREAs and METAREAS MSI providers supporting the Iridium GMDSS System (IGS) and Iridium SafetyCast service are updated on the Iridium website:  
<https://www.iridium.com/gmdss-launch/>

METAREA

METrological AREAs (METAREAs) are identical to the geographical NAVAREAs defined above. The METAREAs are used for the purpose of sending metrological information to mariners.

Coastal Warning Area (CWA)

Coastal Warning Areas are defined in geographical areas, where the NAV/METAREAs are not sufficient to split the coastal warning areas into well-defined areas for transmission of navigational and metrological information. It is possible to configure Coastal Warning Areas in the system, in which it is desirable to receive information from, although you are not in this specific area.

Coastal Warning Areas (CWA)		
NAVAREA No.	Area	Sub-areas
10	Australia	A, B, C, D, E, F, G, and H
14	New Zealand	A

*Table 36: Coastal Warning Areas*

**NOTE:** The Coastal Warning Areas (CWA) listed in Table 36 is reflecting the Coastal Warning Areas supported by the Iridium GMDSS system (IGS) by Commercial Service Introduction (CSI). The list of Coastal Warning Areas should be expected to change over time and more Coastal Warning Areas can dynamically be added by Iridium and will automatically be pushed to the LT-3100S GMDSS system without any user interaction.

Responsible RCC

For each NAV/METAREA there will be at least one responsible Rescue Coordination Center (RCC). All responsible RCCs supporting the Iridium GMDSS Service will automatically be ‘pushed’ to the LT-3100S GMDSS system via the GMDSS configuration file.

**SES Information**

The LT-3100S GMDSS System has a window, which contains registration information about the Ship Earth Station (SES). The SES Information is received from the Iridium GMDSS System (IGS), where information has been registered during commissioning of the system via an Iridium GMDSS Service Provider (SP), see *Maritime Safety Service Activation Form (MSSAF) on page 55* for further details. If information is incorrect please contact your Service Provider.

During completion of the Installation Wizard the SES Information is verified and confirmed. The SES Information is read-only. The SES Information has the following menu path: MENU -> GMDSS -> SES Information.

The SES Information contains the following information:

- SES Name
- SES MSISDN
- SOLAS Vessel
- Vessel Name
- Vessel MMSI
- Vessel IMO No.

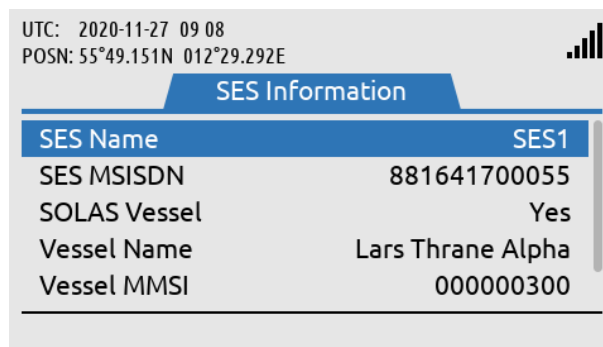

SES Information:  
MENU -> GMDSS -> SES Information

Figure 178: GMDSS submenu (SES Information)

SES Name

SES Name can be configured to either SES1 or SES2, when completing the Iridium Maritime Safety Service Activation Form (MSSAF). Vessels with requirement for only one LT-3100S GMDSS system shall use SES Name = SES1. If the vessel has a requirement for dual GMDSS systems, then SES Name = SES1 and SES Name = SES2 must be registered for the two GMDSS systems onboard.

SES MSISDN

SES MSISDN is an abbreviation for SES Mobile Station International Subscriber Directory Number (MSISDN) and is a unique number identifying the satellite telephone and related to the GMDSS SIM card. It is the MSISDN number which shall be used for incoming non-priority voice calls to the LT-3100S GMDSS system. The MSISDN number is also used as calling party for outgoing non-priority voice calls.

### SOLAS Vessel

SOLAS is an abbreviation for Safety of Life at Sea (SOLAS) and is a maritime convention, which sets minimum requirements and standards for nearly all merchant vessels around the World. The LT-3100S GMDSS system is specified as part of the SOLAS requirements and vessel owners must check and comply with their respective flag states. The Iridium Maritime Safety Service Activation Form (MSSAF) contains information about SOLAS Vessel (Yes or No).

### Vessel Name

Vessel Name must be used which is registered with the local flag state and maritime registration authorities.

### Vessel MMSI

MMSI is an abbreviation for Maritime Mobile Service Identity and is a 9-digit unique number used to identify vessels. The MMSI number is assigned by the local maritime authorities.

### Vessel IMO No.

IMO No. is abbreviation for International Maritime Organization Number and is a unique identification number for a vessel, which must follow the ship throughout its lifetime, also by rebuilding and renaming. The IMO No. consist of the letters *IMO* followed by 7-digits.

**Terminal Test**

The LT-3100S GMDSS system support a ‘Terminal Test’ function, which is testing the satellite link to the Iridium GMDSS System (IGS) and performing the following individual tests: Distress Alert, Distress Call, and Maritime Safety Information (MSI). The Terminal Test function can be activated from the GMDSS submenu (MENU -> GMDSS -> Terminal Test). Figure 179 to Figure 188 illustrates the Terminal Test function.

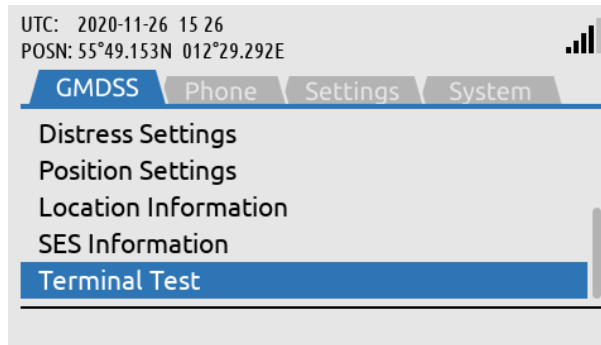

Terminal Test:  
MENU -> GMDSS ->  
Terminal Test

Figure 179: Terminal Test (1 of 10)

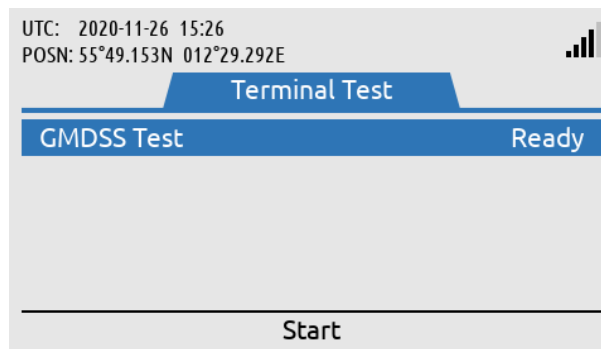

Start the Terminal Test by using the soft key 'Start'.

Figure 180: Terminal Test (2 of 10)

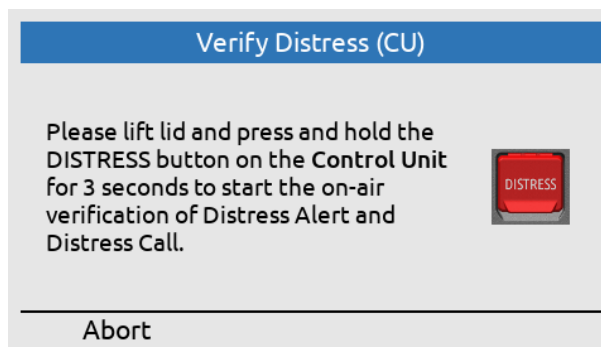

The DISTRESS button must be used to activate the Terminal Test.

Figure 181: Terminal Test (3 of 10)

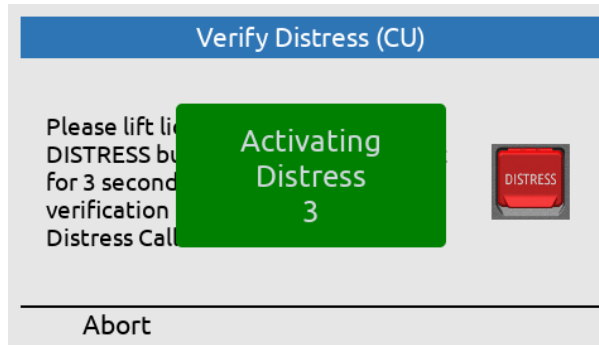

Lift the lid to the DISTRESS button and push the button for a minimum of three seconds (colored green to indicate test).

Figure 182: Terminal Test (4 of 10)

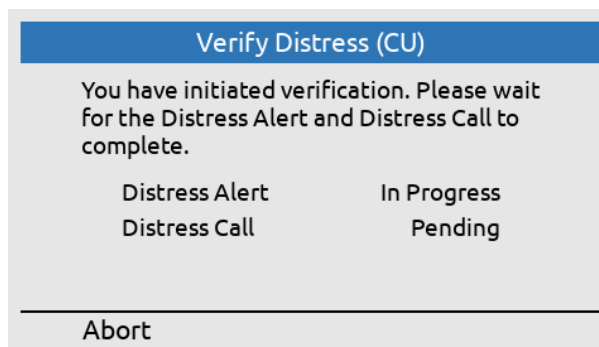

Distress Alert = In Progress  
Distress Call = Pending

Figure 183: Terminal Test (5 of 10)

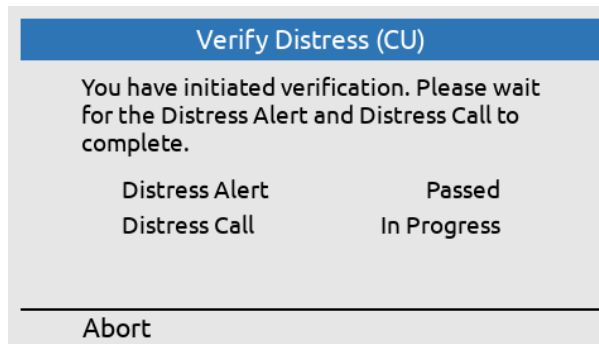

Distress Alert = Passed  
Distress Call = In Progress (voice prompt available)

Figure 184: Terminal Test (6 of 10)

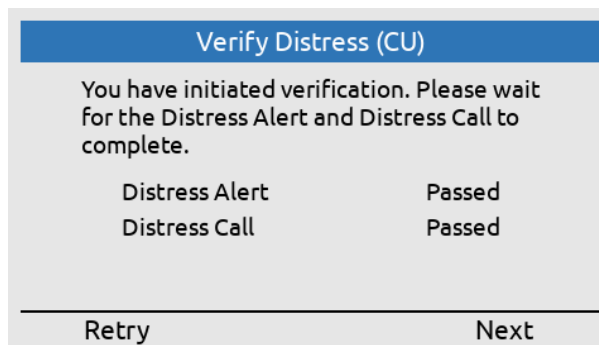

Distress Alert = Passed  
Distress Call = Passed  
Press the soft key 'Next' to continue.

Figure 185: Terminal Test (7 of 10)

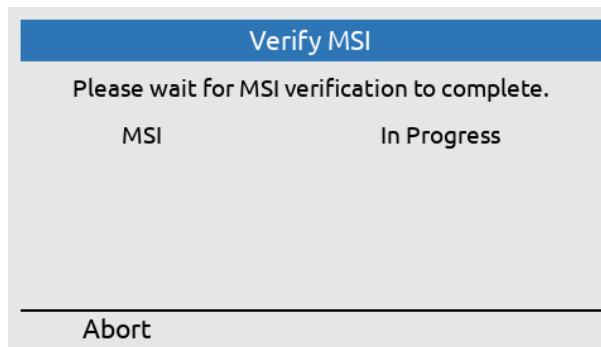

MSI = In Progress

Figure 186: Terminal Test (8 of 10)

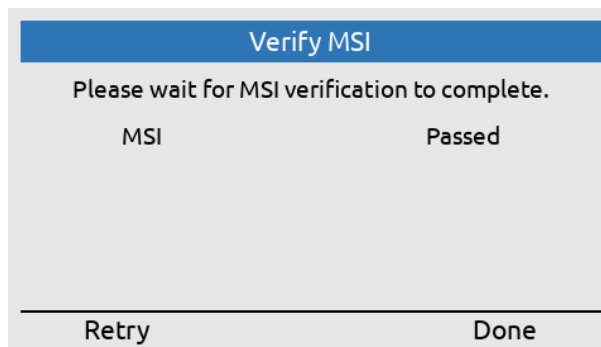

MSI = Passed

Use the soft key 'Done' to exit the Terminal Test.

Figure 187: Terminal Test (9 of 10)



The LT-3100S GMDSS system is now back in the default window and operation.

Figure 188: Terminal Test (10 of 10)

**NOTE:** The Terminal Test function will be completed when the MSI test has passed. By pressing the soft key 'Done' the user will be redirected to the default window.



## System Services

### General Calling

The LT-3100S GMDSS system support General Calling (voice call) outgoing and incoming from phone numbers (incl. Satcom). The voice call is a non-GMDSS service (priority = Routine). The voice service must be activated by the Iridium GMDSS Service Provider in order to work, see System Submenus, *System* on page 143 (Subscription) for status: Voice Service = Subscribed or Not Subscribed. Every voice call will generate a record in the Call History placed in the Phone submenu (MENU -> Phone -> Call History), see *Phone* on page 138.

**NOTE:** Verify that the LT-3100S GMDSS system is ready to make or receive a voice call. Check the network registration status, as illustrated in Table 19 on page 49 (Network Status - Slot 1), which is presenting the signal level and network registration status.

**NOTE:** Always, make sure to have a LT-3120 Handset and LT-3121 Cradle properly installed and connected to the LT-3110S Control Unit. LT-3110S Control Unit handset connector is illustrated in Figure 2 on page 7. The LT-3100S GMDSS system will generate a BAM alert, if the LT-3120 Handset is not connected to the LT-3110S Control Unit (Lost handset).

**NOTE:** The LT-3100S GMDSS system is supporting connection of external SIP phones. The connection of external SIP phones is described in *External SIP Phones* on page 131.

The LT-3100S GMDSS system is supporting Mobile Originated (MO) outgoing and Mobile Terminated (MT) incoming voice calls. The following sub sections will describe and illustrate the outgoing and incoming voice calls.

#### Mobile Originated (MO) - Outgoing

An outgoing voice call can be established as described in Table 37.

Mode	Position of Handset	Description
on-hook	Handset placed in cradle until voice established	Type the number and use the off-hook button.
		Use the off-hook button and select the soft key 'Contacts' or 'Call History'. Select the entry and use the off-hook button to initiate the voice call.
		Navigate to Contacts or Call History by using the MENU button (MENU -> Phone -> Contacts or Call History) and use the off-hook button when the entry has been selected. The voice call will now be established.
off-hook	Handset lifted out of cradle initially	Lift the handset out of the cradle (ready tone is available). Type the number and wait 10 seconds or use the # key to initiate the voice call.

Table 37: Initiate Mobile Originated (MO) Voice Call

The voice call (on-hook and off-hook mode) will be described and illustrated on the following pages.

**On-hook mode:**

In on-hook mode the user can either type in the number directly in the display or use the Contacts or Call History to identify the number to be called while the handset is still placed in the cradle. Once the voice call has been established (duration starts to count) the user can lift the handset out of the cradle. The example in this section shows how to use the off-hook button, identifying an entry in the Contacts, and initiate the voice call by pressing the off-hook button.

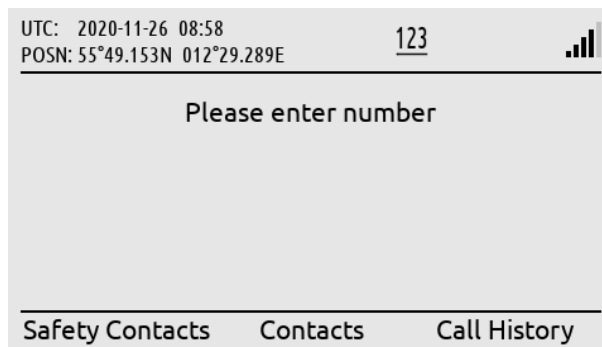

Press the off-hook button (colored green) on the LT-3110S Control Unit. Hereafter press the soft key 'Contacts'.

Figure 189: Outgoing Voice Call, on-hook mode (1 of 5)

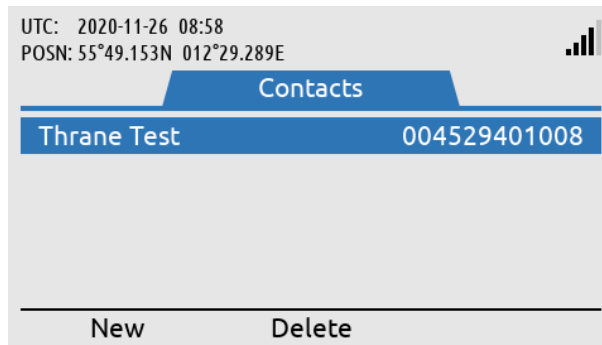

Use the Navigation key and select the contact to be dialed. Press the off-hook button to start connecting the call.

Figure 190: Outgoing Voice Call, on-hook mode (2 of 5)



The LT-3100S GMDSS system is connecting a voice call to the contact 'Thrane Test' (004529401008).

Figure 191: Outgoing Voice Call, on-hook mode (3 of 5)

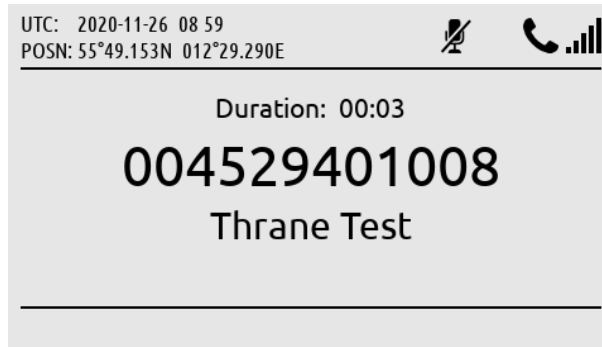

The LT-3100S GMDSS system has established a voice call to 'Thrane Test' (Duration: 00:03).

Figure 192: Outgoing Voice Call, on-hook mode (4 of 5)



The voice call can be terminated by placing the handset in the cradle or use the on-hook button (colored red).

Figure 193: Outgoing Voice Call, on-hook mode (5 of 5)

The mute symbol illustrated in Figure 192 in the status bar will disappear as soon as the handset is lifted out of the cradle. The handset will always be muted when placed in the cradle. The voice from the connected party will be available in the LT-3110S Control Unit speaker, until the handset is lifted out of the cradle. It is always possible to mute and unmute the microphone in the handset from the LT-3110S Control Unit (soft key 'Mute' and 'Unmute') when having an active call and the handset is lifted out of the cradle.

**NOTE:** Adding a new entry in the Contacts (MENU -> Phone -> Contacts) is described and illustrated in *Phone* on page 138.

Off-hook mode:

The off-hook mode can be activated by lifting the handset out of the cradle. In off-hook mode, the user will be met by a *ready tone* and the help text “Please enter number” - hereafter, the called number can be entered, using the numeric keypad. It is not possible to regret, if one or more wrong digits are typed in, for the dialed number. In this case, the user must on-hook the phone, and dial the correct number again. The example below shows how to establish the voice call (the other part of the voice call is identical to the on-hook mode described in the previous section).

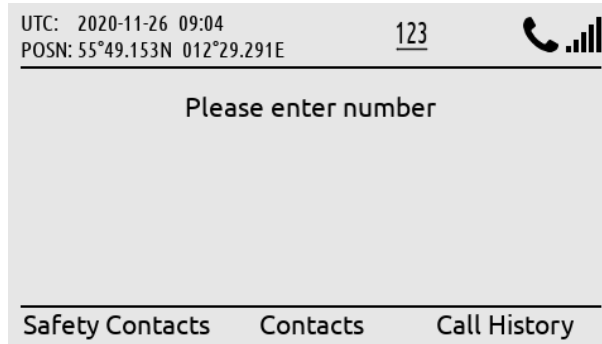

Lift the handset out of the cradle and a ‘ready tone’ will be available in the handset speaker.

Figure 194: Outgoing Voice Call, off-hook mode (1 of 3)

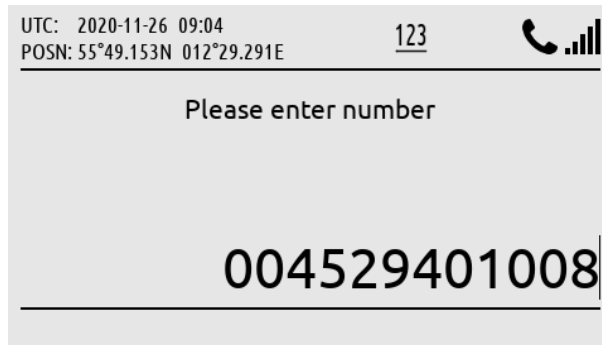

Type the number in the display by using the numeric keypad (it is not possible to regret).

Figure 195: Outgoing Voice Call, off-hook mode (2 of 3)



Use the off-hook button, # key, or wait 10 seconds for the LT-3100S GMDSS system to start connecting the voice call.

Figure 196: Outgoing Voice Call, off-hook mode (3 of 3)

**NOTE:** The LT-3100S GMDSS system will provide the user with information, while connecting and throughout the voice call. In case of problems with the satellite network or connection to the called party (far-end), the user will be informed through a voice prompt, and by status cause codes, that will be presented on the display (e.g. “Temporary link failure”).

Mobile Terminating (MT) - Incoming

The LT-3100S GMDSS system support receiving an incoming voice call. The calling party must use the LT-3100S GMDSS system MSISDN number. The LT-3100S GMDSS system MSISDN number is identified in the GMDSS submenu (MENU -> GMDSS -> SES Information), see *SES Information* on page 115. The LT-3100S GMDSS system will check the calling number up against the Contacts entries, if a match exists, the name of the contact will be showed for the incoming voice call.



Incoming voice call available in the LT-3100S GMDSS system.

Figure 197: Incoming Voice Call (1 of 3)



The handset has been lifted out of the cradle and the voice call is established.

Figure 198: Incoming Voice Call (2 of 3)

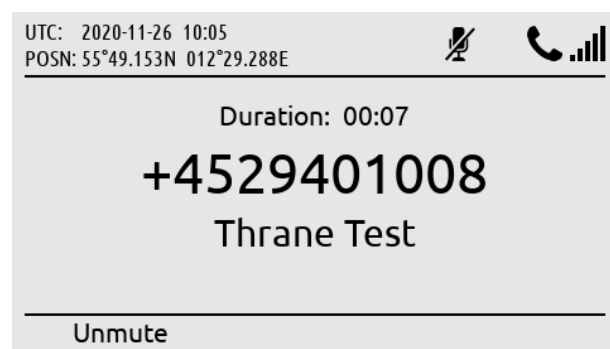

The voice call can be muted. To mute/unmute the handset microphone during a voice call, use the soft key 'Mute' and 'Unmute'.

Figure 199: Incoming Voice Call (3 of 3)

**NOTE:** The General Calling (priority = routine) voice call must be activated by the Iridium GMDSS Service Provider (SP) in order to work. Check subscription status in the System submenu (MENU -> System -> Subscription Status), see *System* on page 143.

An incoming missed voice call is illustrated in the following figures: Figure 200 to Figure 202. By pressing the soft key 'Missed Calls(1)' the user will be redirected to the Call History (filter: Missed Calls). By pressing the soft key 'Show All', all Call History records will be shown (all incoming and outgoing calls).

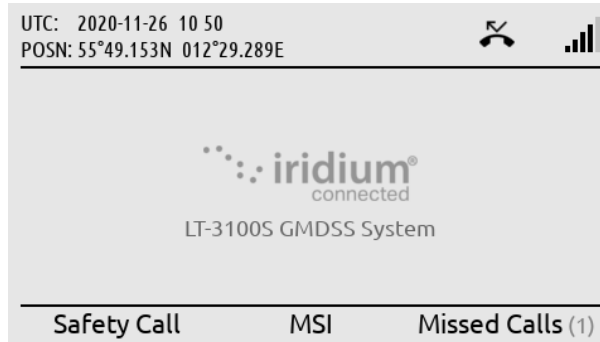

A missed voice call is illustrated in the display (symbol in status bar and soft key showing 'Missed Calls(1)').

Figure 200: Incoming Voice Call, missed (1 of 3)

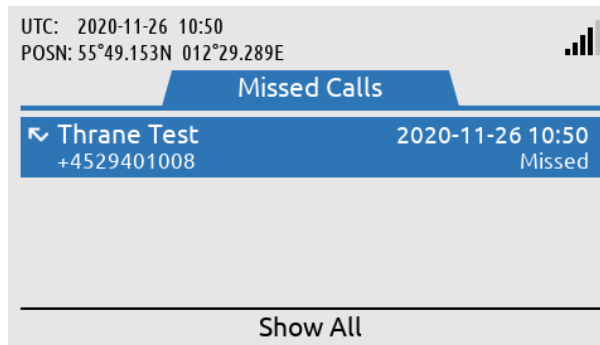

By pressing the soft key 'Missed Calls(1)' the user will be directed to the Call History (Missed Calls).

Figure 201: Incoming Voice Call, missed (2 of 3)

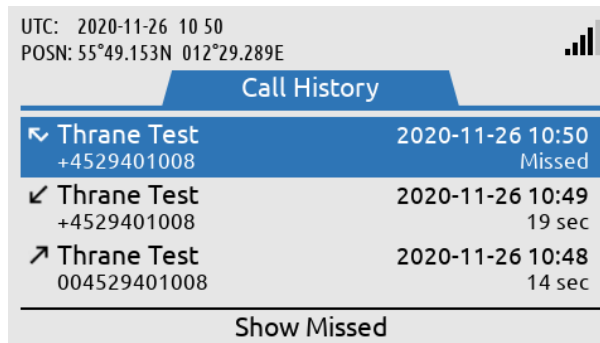

Press the soft key 'Show All' and the normal view of the Call History will be shown.

Figure 202: Incoming Voice Call, missed (3 of 3)

**NOTE:** An incoming missed voice call is illustrated in the above figures. By highlighting the missed call in the Call History and press the off-hook button, the LT-3100S GMDSS system will start establishing a voice call to the party.

**General Messaging (SMS)**

The LT-3100S GMDSS system support General Messaging (SMS) sending and receiving from traditionally phone numbers (incl. Satcom) and E-mail addresses. SMS is a non-GMDSS service (priority = Routine). The SMS service must be activated by the Iridium GMDSS Service Provider in order to work, see *System Submenus, System* on page 143 (Subscription) for status: SMS Service = Subscribed or Not Subscribed.

The LT-3100S GMDSS system support sending and receiving concatenating SMS (SMS' consisting of multiple instances). A standard SMS (single instance) is consisting of 160 characters. A concatenated SMS send from the LT-3100S GMDSS system is delivered as individual SMS' (error in the network). A concatenated SMS received in the LT-3100S GMDSS system is received and displayed correctly.

Sending an E-mail from the LT-3100S GMDSS system is handled similar to sending a SMS, although it is needed manually to insert the E-mail address in the 'To:' field (use the # key to toggle between numbers and letters). If sending an E-mail to the LT-3100S GMDSS system, then leave the Subject-field empty. Please note that all text larger than an SMS (160 characters) is truncated and that the length of the E-mail address + one character is deducted from the payload text. When sending an E-mail to the LT-3100S GMDSS system, then the MSISDN number must be used (e.g. 88163XXXXXX@msg.iridium.com). Don't use international prefix ('+' or '00' in front of the MSISDN number).

The SMS Service is located in the Phone submenu (MENU -> Phone -> SMS), as illustrated in Figure 203.

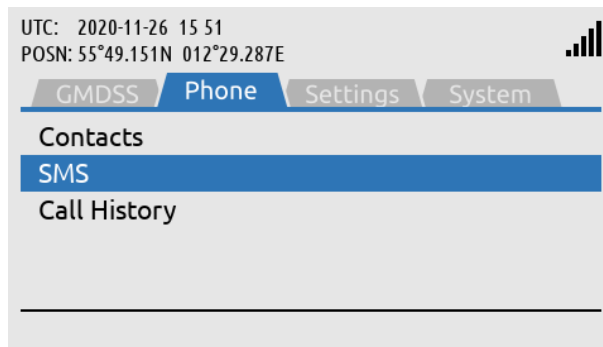

General Messaging (~SMS):  
MENU -> Phone -> SMS

Figure 203: Phone submenu (General Messaging ~SMS)

**NOTE:** The LT-3100S GMDSS system support SMS sending and receiving from traditionally phone numbers (incl. Satcom) and E-mail addresses. The SMS Service must be activated with the Iridium GMDSS Service Provider (SP).

**NOTE:** The LT-3100S GMDSS system can store minimum 500 SMS' in total (sent and received). An individual SMS or SMS conversations can be deleted from the SMS window. To delete all SMS' at once, navigate to the Settings submenu (MENU -> Settings -> Reset Options: Delete SMS Messages).

Sending SMS

To send a SMS, the user of the LT-3100S GMDSS system must access the Phone submenu (MENU -> Phone -> SMS). In the SMS window all sent and received SMS are visible. In Figure 204 the SMS window is illustrated with 'No Messages'. Press the soft key 'New' to prepare a new SMS. It is possible to reply to an existing conversation (phoner number, E-mail address) when entries are available. Figure 204 to Figure 208 illustrates sending a new SMS (to a normal phone number).

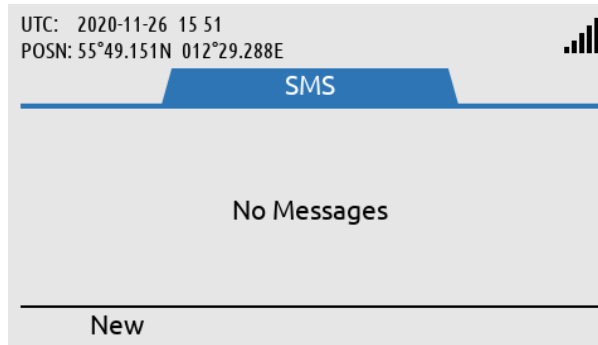

No SMS' are available in the LT-3100S GMDSS system (sent or received). Use soft 'New' to prepare a new SMS.

Figure 204: Sending SMS (1 of 7)

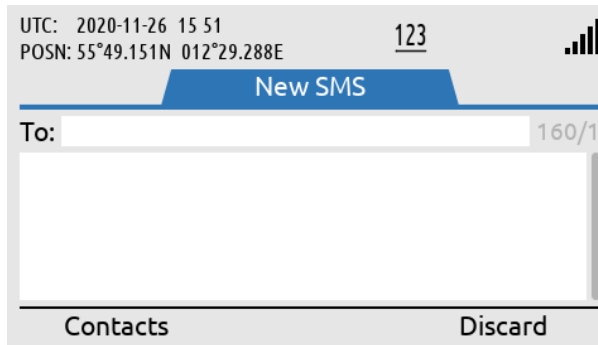

Use soft key 'Contacts' or enter the number directly in the To-field.

Figure 205: Sending SMS (2 of 7)

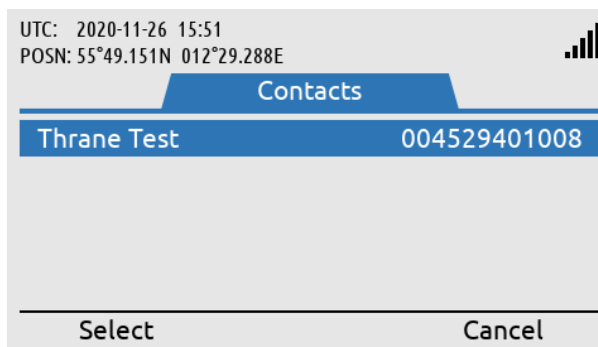

If Contacts has been chosen, then select the contact by using the Navigation key and the soft key 'Select'.

Figure 206: Sending SMS (3 of 7)

**NOTE:** Use the # key to toggle between numbers and letters in the 'To:' field (needed when sending to an E-mail address destination).



Press the soft key 'Send' when the destination address and body text have been completed. The SMS service will indicate the transmitting status, which will change from 'Sending' to 'Sent' when the SMS has successfully been sent from the LT-3100S GMDSS system, see Figure 209 and Figure 210.

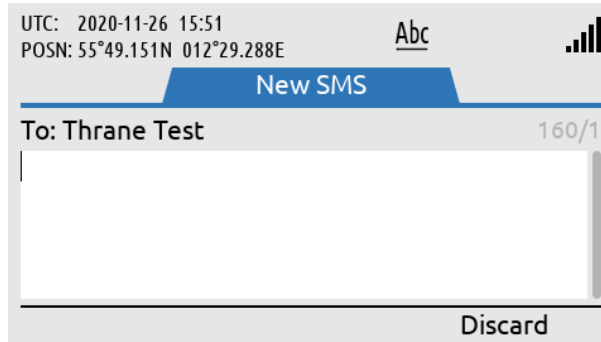

Write the SMS text.

Figure 207: Sending SMS (4 of 7)

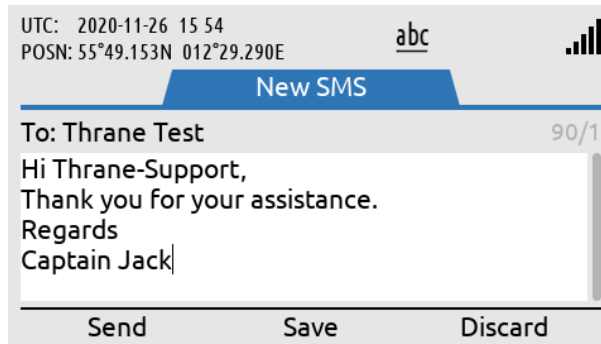

When the SMS is ready to be sent use the soft key 'Send'.

Figure 208: Sending SMS (5 of 7)

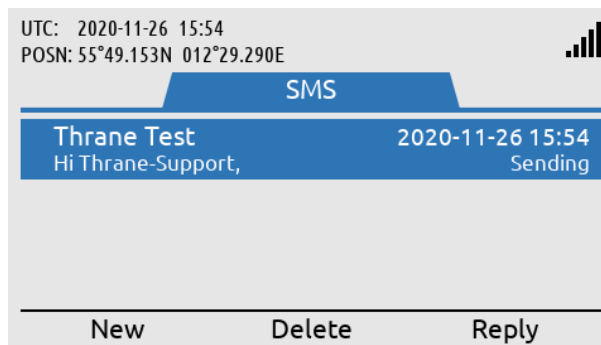

The SMS will change status from Sending to Sent when the SMS has successfully been sent.

Figure 209: Sending SMS (6 of 7)

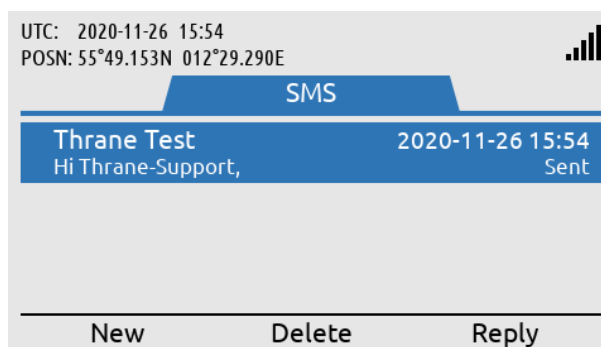

The SMS has successfully been sent. Otherwise, retry option is available.

Figure 210: Sending SMS (7 of 7)

**NOTE:** If sending the SMS is failing (the SMS window will indicate 'Failed'), then a 'Resend' soft key will be available for the user to make another try. A successful SMS sending will be indicated by 'Sent' - this information will be replaced by 'Now' and hereafter the time since the SMS was successfully sent (e.g. '19 hours ago' and so forth).

Receiving SMS

A received SMS will be indicated by the unread symbol in the status bar, a notification tone, and the soft key 'SMS(1)' will be shown as illustrated in Figure 211 (if no unread Safety Messages are available).



The LT-3100S GMDSS system has received a SMS, see symbol in status bar and soft key 'SMS(1)'.

Figure 211: Receiving SMS (1 of 3)

To read the incoming SMS, press the softkey 'SMS(1)' or navigate to the Phone submenu (MENU -> Phone -> SMS). The unread symbol will be removed as soon as the SMS has been read. Open the individual SMS or SMS conversation by pressing the ENTER button. Use the soft key 'Reply' to reply to a sent or received SMS.

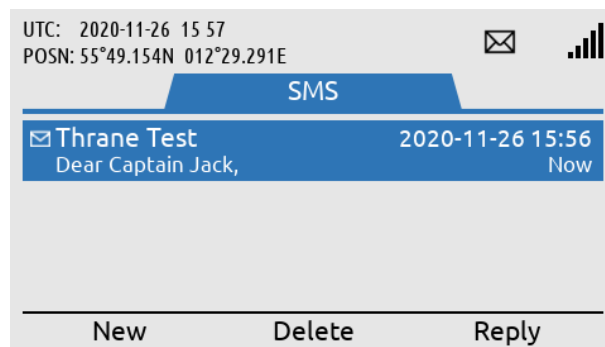

Press the soft key 'SMS(1)' and the user will be directed to the SMS window.

Figure 212: Receiving SMS (2 of 3)

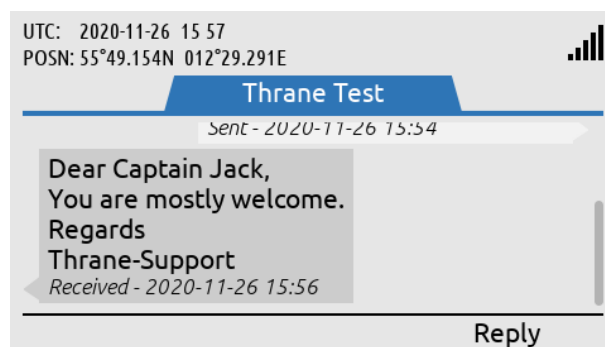

Use the ENTER button to open the received SMS.

Figure 213: Receiving SMS (3 of 3)

**NOTE:** The LT-3100S GMDSS system is handling SMS conversions, which is grouped based on the recipient's address.

**External SIP Phones**

The LT-3100S GMDSS system is supporting connection of external SIP phones, up to 8 external SIP phones. The configuration of the SIP phones must be completed via the web server, see *SIP* on page 164. Figure 214 is illustrating the connection of the external SIP phones. Connect the SIP phones directly to the LT-3110S Control Unit Ethernet (LAN port) or via the LT-3140S Interface Unit (use the spare LAN ports).

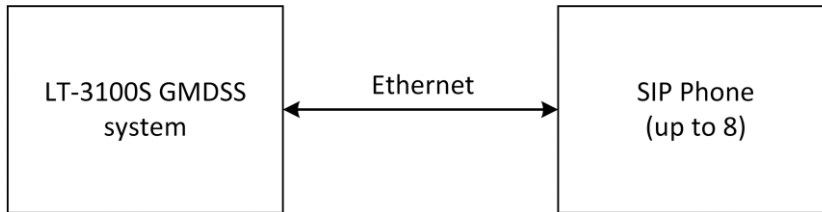
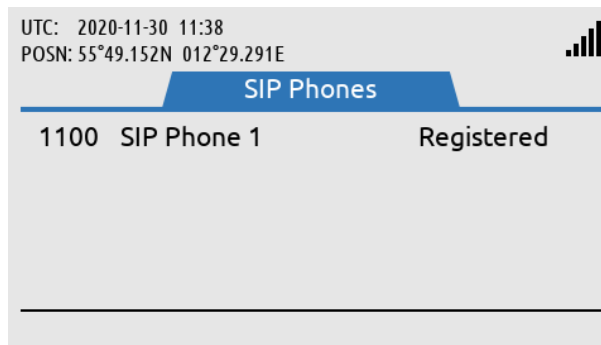

Figure 214: SIP phones

**NOTE:** The SIP phone might require a DHCP Server to get an IP address assigned. Depending on network setup, it might be needed to configure DHCP Server mode in the LT-3100S GMDSS system.

The LT-3110S Control Unit UI display (MENU -> System -> SIP Phones) will provide a 'live' registration status of the SIP phones configured from the web server.



SIP Phones:  
MENU -> System -> SIP  
Phones

Figure 215: System Submenu (SIP Phones)

An active voice call to/from a SIP phone will be presented in the Status bar with the symbol showed in Figure 216. External SIP phones can only use the General Calling (priority = Routine).

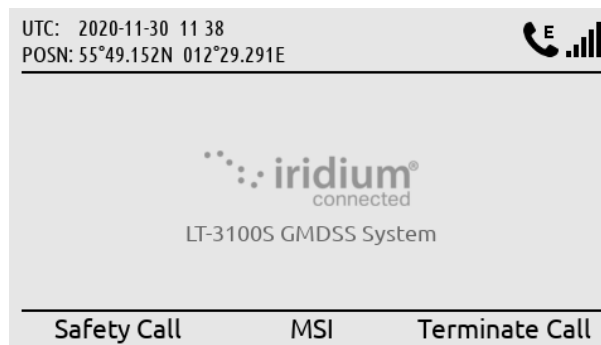

External SIP voice call is using the satellite connection. Can be terminated by using the soft key 'Terminate Call'.

Figure 216: External SIP Voice Call

By using the soft key 'Terminate Call', the external voice call from the SIP phone will be terminated. A voice call from an external SIP phone will automatically be preempted, if a service with higher priority (Safety, Urgency, or Distress) is presented.

An incoming voice call taken by the SIP phone cannot be forwarded. Once a voice call has been taken by any of the 'lines' the voice call is locked to this user.

The LT-3100S GMDSS system is supporting local calling between the SIP phones and the LT-3120 Handset. The number plan is illustrated in Table 38. The Caller ID is defined by the user, when configuring the SIP phones.

LT-3100S GMDSS System Number Plan (local calls)		
Number	Caller ID	Comments
1000	LT-3100S User	LT-3120 Handset
1100	SIP Phone 1	
1101	SIP Phone 2	
1102	SIP Phone 3	
1103	SIP Phone 4	
1104	SIP Phone 5	
1105	SIP Phone 6	
1106	SIP Phone 7	
1107	SIP Phone 8	

Table 38: Number Plan (local calls)

**NOTE:** The LT-3100S GMDSS system is only supporting one outgoing satellite voice connection. A local call between two local users will not busy the Satellite voice connection.

## Analogue Phone Adapter

The LT-3100S GMDSS system is supporting connection of an external Analogue Phone Adapter (e.g. Grandstream). The number of POTS' phones (Plain Old Telephone System), which can be connected to the Analogue Phone Adapter, must be configured as SIP phones in the LT-3100S GMDSS system, see configuration of SIP phones in *SIP* on page 164. Connect the SIP phones directly to the LT-3110S Control Unit Ethernet (LAN port) or via the LT-3140S Interface Unit (use the spare LAN ports).

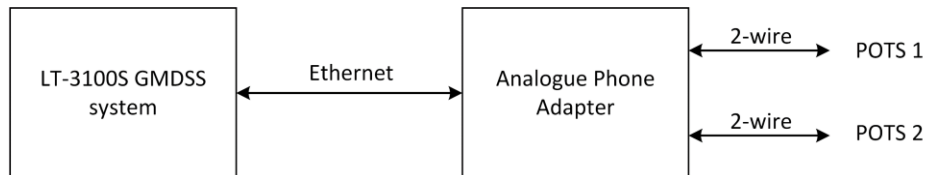

Figure 217: Analogue Phone Adapter

**NOTE:** The Analogue Phone Adapter might require a DHCP Server to get an IP address assigned. Depending on network setup, it might be needed to configure DHCP Server mode in the LT-3100S GMDSS system.

The Analogue Phone Adapter (POTS phones) will be handled as SIP phones in the LT-3100S GMDSS system. Therefore, carefully read the section describing the SIP phones in section *External SIP Phones* on page 131.

In order to provide some guidance for configuration of an Analogue Phone Adapter, the following description will outline some important steps for configuring an Analogue Phone Adapter.

### Configuration of Grandstream HT802 Adapter (example):

*If you would like to connect the Analogue Phone Adapter directly to the LT-3100S GMDSS system, then it might help you to insert a passive switch between the LT-3100S GMDSS system and the Analogue Phone Adapter, while completing the setup (to allow for an extra LAN port during configuration).*

- Step 1: Connect the LT-3100S GMDSS system, Analogue Phone Adapter, and PC using a passive switch
- Step 2: Login to the LT-3100S GMDSS system web server. The IP address can be read from the display (MENU -> System -> Network: IP address)
- Step 3: Configure the LT-3100S GMDSS system to 'DHCP Server' mode (depending on network setup) and configure the SIP phones (Password, and Caller ID)
- Step 4: The Analogue Phone Adapter will now have an IP address assigned. Connect a POTS phone to the Analogue Phone Adapter and use the IVR menu to read out the IP address (off hook handset and type '\*\*\*' followed by '02'). Check the instructions provided for the Analogue Phone Adapter
- Step 5: Log in to the Analogue Phone Adapter and configure FXS PORT 1 and PORT 2 (Primary SIP Server, SIP User ID, Authenticate ID, Password, and Name)
- Step 6: The POTS phones should now be registered and ready to use (the passive switch can be removed)

**Modem Data**

Modem Data (incl. RUDICS) is not supported in this release of the LT-3100S GMDSS User & Installation Manual and in the corresponding software. The software is defined in Table 1 on page vi.

**NOTE:** Check, if you have the newest released LT-3100S GMDSS User & Installation Manual and whether any LT-3100S GMDSS Software Release Notes has been published on the company's website.

**Tracking**

The LT-3100S GMDSS system is supporting tracking functionality. The periodic tracking functionality must be configured from the LT-3100S GMDSS system web server, see Configuration - Tracking in *Tracking* on page 165. The LT-3100S GMDSS system tracking functionality is a non-GMDSS functionality, which the user of the system can configure and use for any private purpose.

The LT-3100S GMDSS system is supporting the following tracking formats:

Transport Types & Report Formats	
Transport Type	Report Format
SMS	Thrane (text) Human readable
E-mail	Thrane (text) Human readable
SBD	<i>Not supported</i>

*Table 39: Tracking Transport Types & Report Format*

If periodic tracking reports have been configured by the user of the LT-3100S GMDSS system in the web server, then a tracking symbol will be shown in the status bar of the LT-3110S Control Unit display. Also, this is to inform the user that tracking reports will be sent periodically.



Figure 218: Periodic Tracking Activated

The user of the LT-3100S GMDSS system can access the Tracking window (MENU -> System -> Tracking) to get some details about the periodic tracking configuration and reports. See Figure 219 on page 136 for the layout of the Tracking window.



The Tracking window shown in Figure 219 illustrates the following periodic tracking configuration:

- Time trigger: Enabled, Timer interval = 12:00 (HH:MM)
- Distance trigger: Enabled, Distance interval = 50.0 (NM), Minimum time interval = 04:00 (HH:MM)

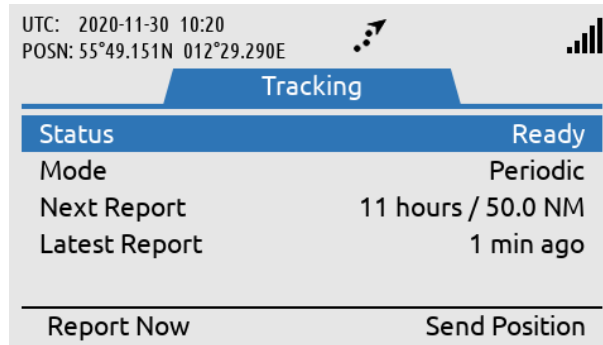

Figure 219: Tracking submenu

Last Report is indicating '1 min ago' because the soft key 'Report Now' button has been used. The soft key 'Report Now' can be used to send additional tracking reports, if tracking has been configured in the web server. Otherwise for this configuration, periodic tracking reports are to be sent every 12 hours / 50 NM (minimum time interval: 4 hours), whatever is first triggered, time or distance.

If Time and/or Distance trigger have been enabled, then Mode is set to Periodic. If none of these trigger conditions have been enabled, then Mode is set to Manual. If the Mode is configured to Manual, then only tracking configuration Options 'Send report on power-on' (configuration parameter from the web server) or the soft key 'Report Now' can activate a tracking report.

If selecting the Last Report using the Navigation key, then you will see the details of this last tracking report sent, as illustrated in Figure 220.

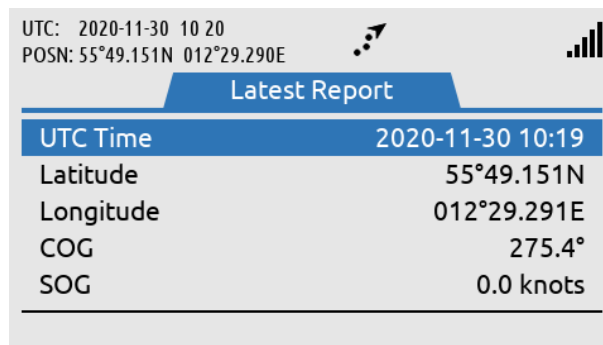

Figure 220: Tracking (Last Report)

**NOTE:** The LT-3100S GMDSS system support configuration of periodic tracking reports using different transport types and formats. The periodic tracking reports must be configured using the web server, see Configuration - Tracking in *Tracking* on page 165.

Instead of using the periodic tracking report, it is possible without any configuration, to send a tracking report using the Tracking window (MENU -> System -> Tracking). Use the soft key 'Send Position' as illustrated in Figure 219 on page 136.

The LT-3100S GMDSS system will preformat a tracking report using the SMS functionality and layout, where the user optionally can select between a regular subscriber number and an E-mail address. Use the hash '#' key to toggle between numbers and letters in the 'To:' field. It is possible edit the body text with optionally information to the recipient of the tracking report. Whenever the recipient address and body text are completed, use the Navigation key to enter the body text field and the soft key 'Send' will appear. Press the soft key 'Send' and status about transmitting the SMS will be available to the user. The functionality is illustrated in Figure 221 and in Figure 222.

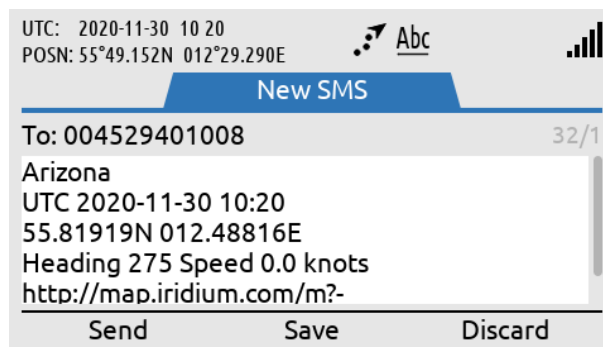

Figure 221: Tracking (Send Position)

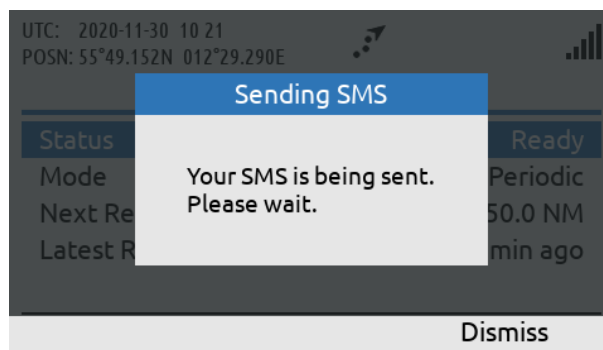

Figure 222: Tracking (Send Position)

**NOTE:** The LT-3100S GMDSS system can send preformatted tracking reports from the Tracking window without any preceding configuration. Enter the Tracking window (MENU -> System -> Tracking) and press the soft key 'Send' to activate this functionality and select between regular subscriber number and E-mail recipient address.

## System Submenus

This section describes and illustrates all the non-GMDSS submenus: Phone, Settings, and System. The submenus are accessed by pressing the MENU button.

### Phone

The Phone submenu contains the following entries: Contacts, SMS, and Call History. See Figure 223 for the layout of the Phone submenu.

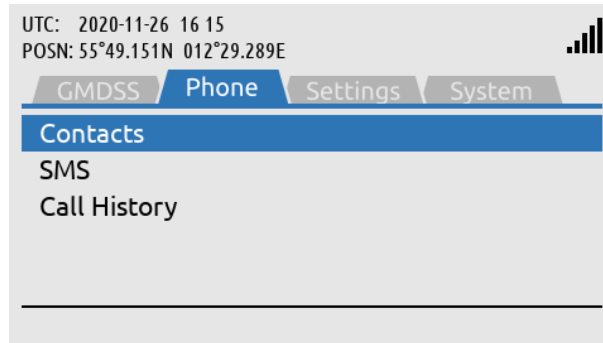

SIP Phones:  
MENU -> Phone

Figure 223: Phone submenu

### Contacts

The Contacts provides a list of contacts created by the user. Create a new contact by pressing the soft key 'New' and add phone number and name. The phone number is limited to numbers (e.g. 004529401008). It is currently not possible to add E-mail addresses under contacts. The Contact list can contain 100 contacts. Use international number prefix, either '+' or '00XX' in front of the number. A contact can be deleted from the list by pressing the soft key 'Delete' and confirm this.

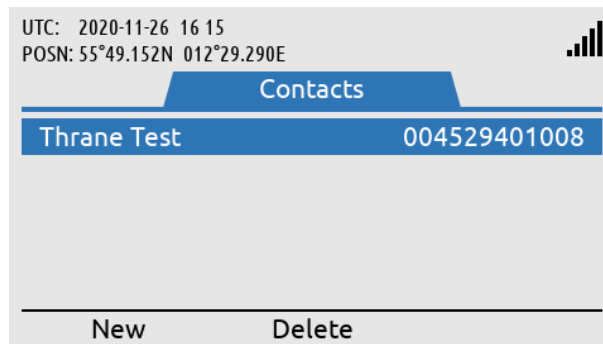

Contacts:  
MENU -> Phone ->  
Contacts

Figure 224: Phone submenu (Contacts)

**NOTE:** The user can select an entry from the Contacts (e.g. Thrane Test) and use the Off-hook button to establish a voice call to the contact.

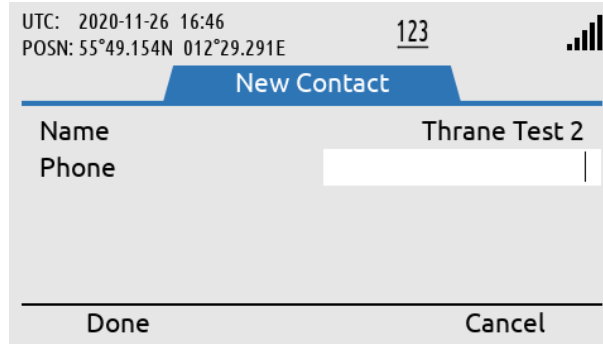

Figure 225: Contacts (New Contact)

SMS

The SMS Service is described and illustrated *General Messaging (SMS)* on page 126.

Call History

The Call History provides a complete list of all voice calls (Safety and General Calling): outgoing, incoming, and missed calls, as illustrated in Figure 226. ‘Unknown’ entries in the Call History will show the soft key ‘New Contact’ to help creating the ‘Unknown’ contacts in the Contact list. Use the soft key ‘Show Missed’ to filter for incoming missed calls.

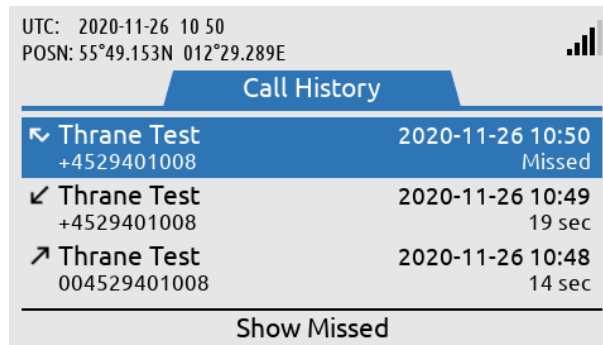

Call History:  
MENU -> Phone -> Call History

Figure 226: Phone submenu (Call History)

**Settings**

The Settings submenu contains the following entries: Audio, Display, Date & Time, and Reset Options. See Figure 227 for the layout of the Settings submenu.

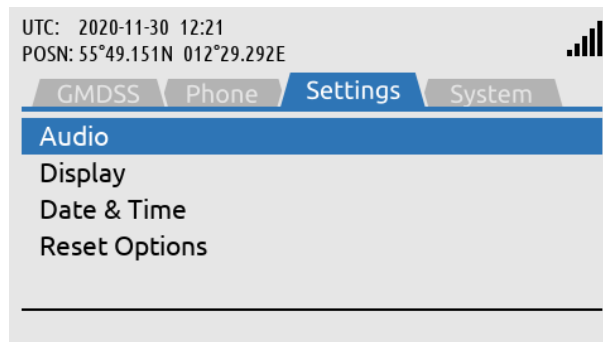

Settings:  
MENU -> Settings

Figure 227: Settings submenu

Audio

The Audio settings handles all audio levels and notifications. Here is a short description of the audio settings and their functionality in the LT-3100S GMDSS system (see Figure 228 for layout):

- *Speaker Volume* adjusts the output level of the LT-3110S Control Unit speaker (located below the DISTRESS button). The Speaker Volume setting is primarily used when operating the system with the LT-3120 Handset placed in LT-3121 Cradle (e.g. making a voice call). The Navigation key (arrows up/down) can be used to control the Speaker Volume output level, when audio is directed to control unit speaker.
- *Handset Volume* adjusts the output level of the LT-3120 Handset speaker (user audio). The user can adjust the Handset Volume during a voice call by using the LT-3120 Handset volume button (up/down) on the side of the handset.
- *Ringer Volume* adjusts the output level of the ringer, when an incoming voice call is presented in the LT-3100S GMDSS system. The Ringer output will be directed to the LT-3120 Handset (integrated ringer speaker on the back side) when placed in the LT-3121 Cradle. Otherwise, the LT-3110S Control Unit speaker is used for indicating an incoming voice call.
- *Key Beep* adjusts the output level of the audio feedback when using the LT-3110S Control Unit keypad. Can be configured to 'Off' if desired.

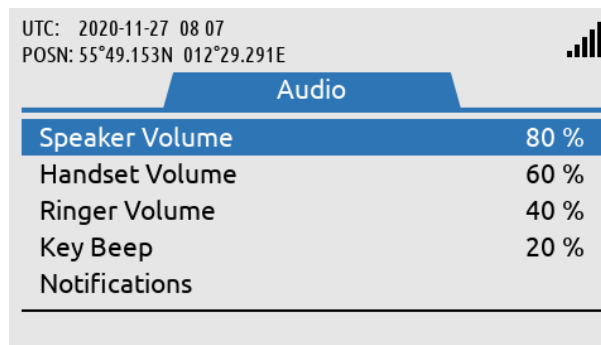

Audio:  
MENU -> Settings ->  
Audio

Figure 228: Settings submenu (Audio)

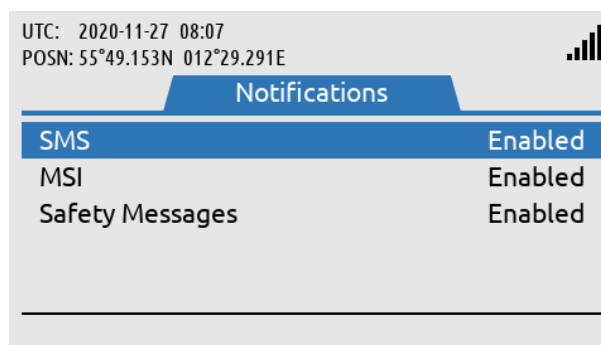

Notifications:  
MENU -> Settings ->  
Audio -> Notifications

Figure 229: Settings Submenu (Notifications)

**NOTE:** Audio notifications can be disabled for SMS, MSI, and Safety Messages. For MSI and Safety Messages the audio notification configuration is only valid for priority = Safety. The unread symbol in the status bar will still be shown, if audio notifications are disabled.

Display

The Display settings handles all display settings: mode (day or night time) and brightness.

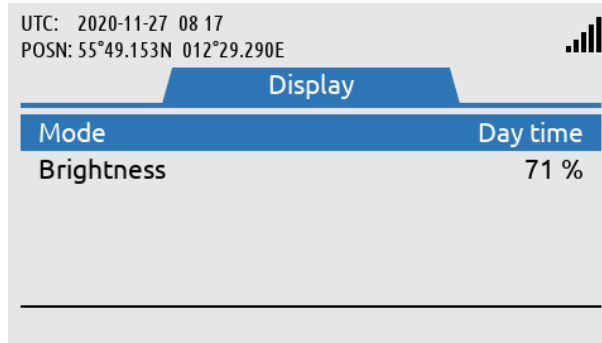

Display:  
MENU -> Settings ->  
Display

Figure 230: Settings submenu (Display)

**NOTE:** The display settings can also be configured using the 'Power & DIM' button. Short press on the 'Power & DIM' button changes the brightness, whereas long press on the 'Power & DIM' button changes between day and night time.

Date & Time

Date & Time settings provides the user with a possibility to change formats after completing the Installation Wizard. The LT-3100S GMDSS system support the following date formats: YYYY-MM-DD, D MMM YYYY, DD/MM/YYYY, and MM/DD/YYYY. The time format can be configured to either 24 or 12 hours.

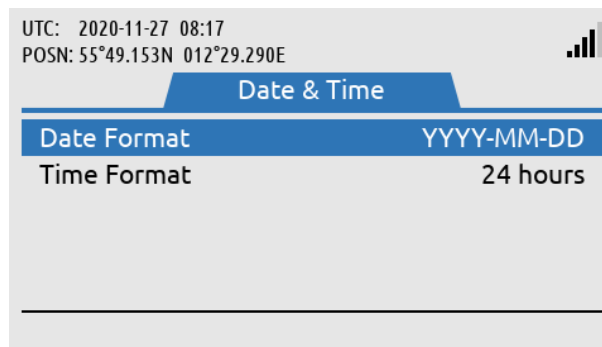

Date & Time:  
MENU -> Settings -> Date  
& Time

Figure 231: Settings submenu (Date & Time)

**NOTE:** The Date & Time format will be configured initially when completing the Installation Wizard. The Installation Wizard is described and illustrated in *Installation Wizard* on page 57.

Reset Options

The Reset Options handles the reset of the following user records and configurations: Call History, SMS, and Web Server Authentication. Use the soft key 'Execute' or the 'ENTER' button to activate the reset, when the correct Reset Option has been selected by the 'Navigation' key (arrow up/down). The user of the LT-3100S GMDSS system will have to confirm the reset, see Figure 232 and Figure 233.

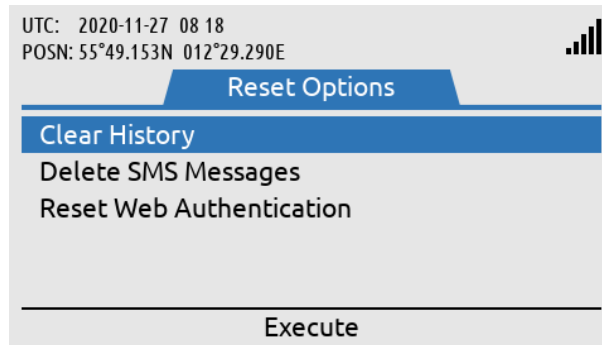

Reset Options:  
MENU -> Settings ->  
Reset Options

Figure 232: Settings submenu (Reset Options)

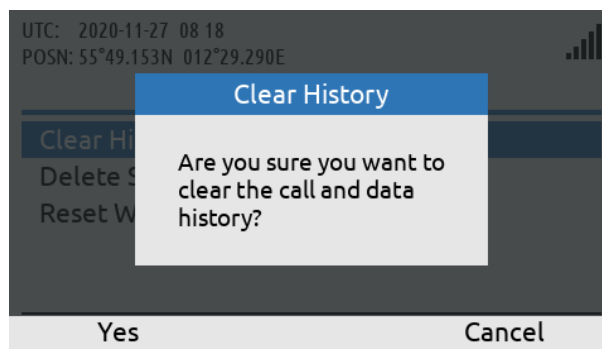
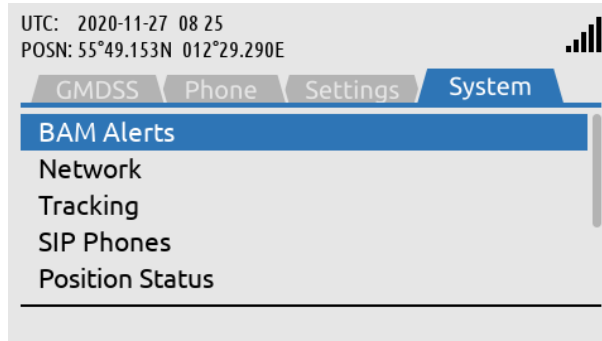

Figure 233: Settings submenu (Reset Options)

**NOTE:** The reset of the web server authentication can be managed from the Settings submenu for the user to get access to the web server in the situation, where the user cannot find the changed password. To avoid unwanted access to the web server via the network interface, it is highly recommended to change the web server authentication password at any time. The web server authentication is described and illustrated in *Authentication* on page 160.

**System**

The System submenu contains the following entries: BAM Alert, Network, Tracking, SIP Phones, Position Status, Subscription, System Info, and Power Supply. See Figure 234 and Figure 235 for the layout of the System submenu.



System:  
MENU -> System  
(upper view)

Figure 234: System submenu

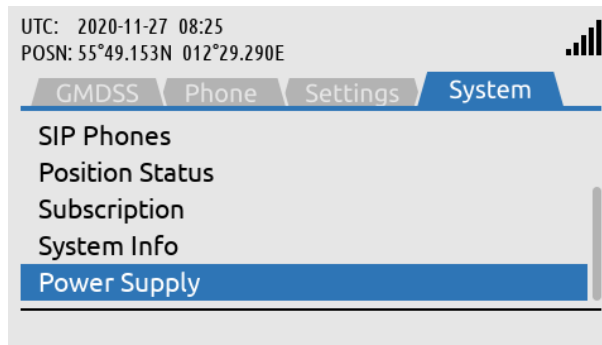

System:  
MENU -> System  
(lower view)

Figure 235: System submenu

BAM Alerts

BAM Alerts provides an overview of the active alerts in the LT-3100S GMDSS system. The Bridge Alert Management (BAM) is described and illustrated in detail in *Bridge Alert Management (BAM)* on page 148.

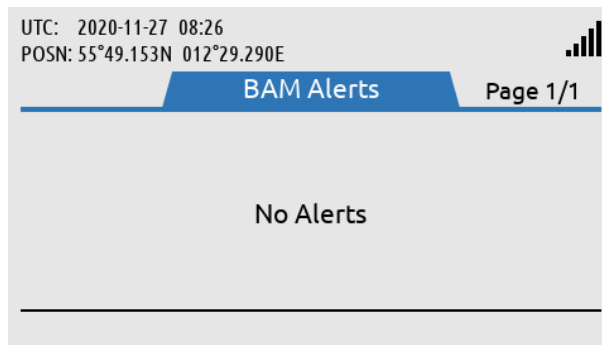

BAM Alerts:  
MENU -> System -> BAM Alerts (or long press on the MENU button)

Figure 236: System submenu (BAM Alerts)

**NOTE:** The BAM Alerts list illustrated in Figure 236 should under normal conditions be empty (No Alerts). Make sure to read the alerts carefully and take appropriate action.



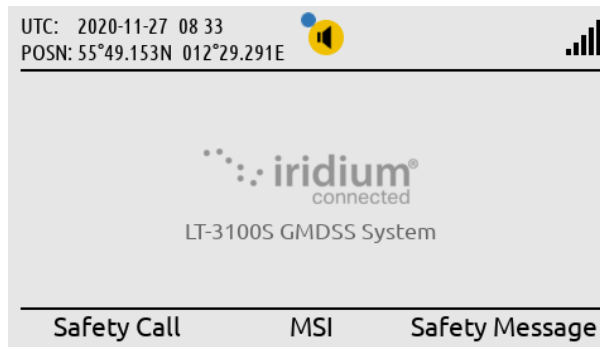

BAM alert shown in the status bar (active warning). The blue dot indicates a change in the BAM Alerts, after the user has last been in the list.

Figure 237: BAM Alerts (1 of 4)

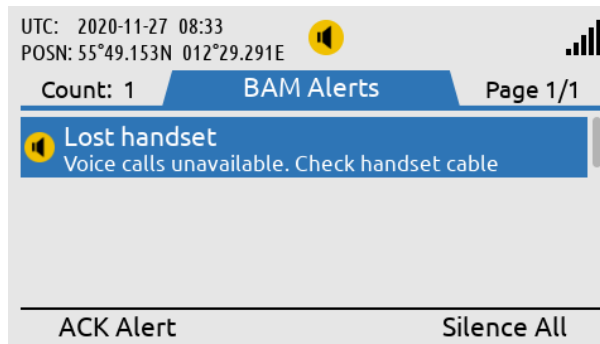

Long press on the MENU button to access the BAM Alerts (Lost Handset).

Figure 238: BAM Alerts (2 of 4)

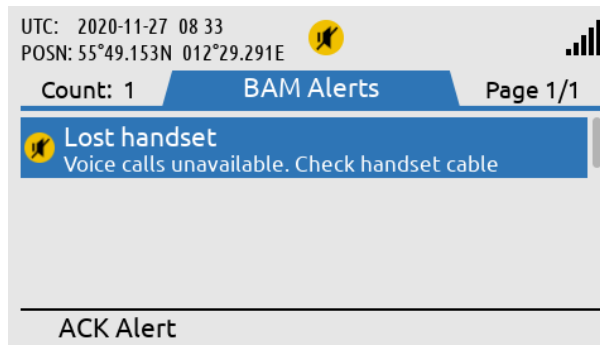

Press the soft key 'Silence All' to mute the audible alarm for 30 seconds.

Figure 239: BAM Alerts (3 of 4)

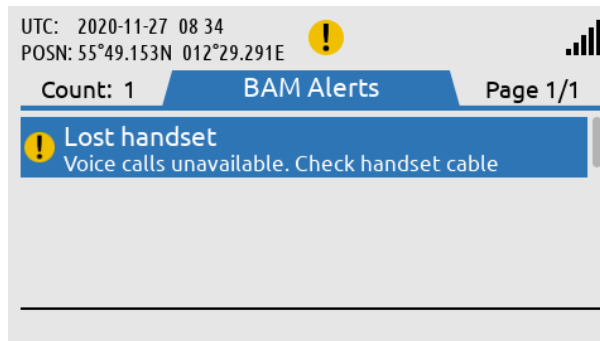

Press the soft key 'ACK Alert' acknowledge the BAM alert.

Figure 240: BAM Alerts (4 of 4)

Network

The Network provides an overview for the user of the LT-3100S GMDSS system of the IP network configuration and setup. The LT-3100S GMDSS system can be configured to: DHCP Client, DHCP Server, and Static IP address. The link status will provide the user with information about and whether an IP connection is established to the LT-3110S Control Unit. The IP address of the LT-3110S Control Unit is provided under the IP Address parameter illustrated in Figure 241.

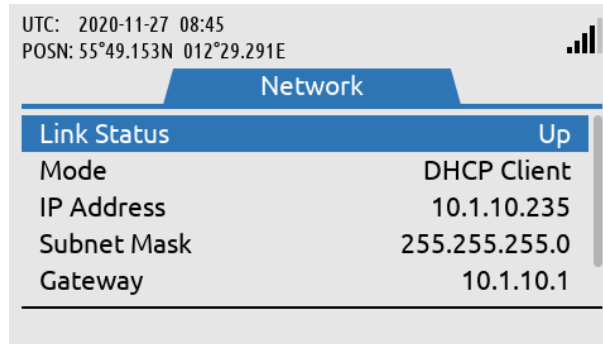

Network:  
MENU -> System ->  
Network

Figure 241: System submenu (Network)

**NOTE:** Use the IP Address to access the built-in web server. Instructions to access the built-in web server is provided in *Accessing the built-in web server* on page 157.

Tracking

The Tracking functionality is described and illustrated in *Tracking* on page 135.

SIP Phones

The SIP Phones functionality is described and illustrated in *External SIP Phones* on page 131.

Position Status

The Position Status provides an overview for the user of the LT-3100S GMDSS system built-in GNSS receiver. The GNSS receiver can be configured from the web server, see *GNSS, BAM and MSI* on page 171.

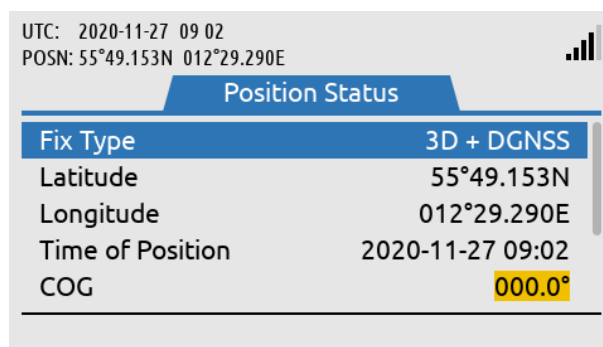

Position Status:  
MENU -> System -> Position  
Status  
(upper view)

Figure 242: System submenu (Position Status)

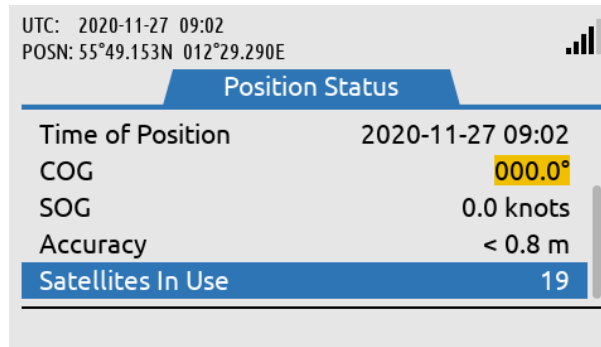

Position Status:  
MENU -> System -> Position  
Status  
(lower view)

Figure 243: System submenu (Position Status)

**NOTE:** The Position Status window shows the GNSS receiver status (in Automatic GNSS mode). The Manual Position input will not be shown in the Position Status window. The Position Status (Automatic GNSS) integrity states are further described and illustrated in *App. G - GNSS Receiver Integrity States (Automatic GNSS)* on page 197.

Subscription

The LT-3100S GMDSS system support both General Calling (priority = Routine) and General Messaging (priority = Routine), also mentioned as Voice Call and SMS. The Voice and SMS Service must be activated with the Iridium GMDSS Service Provider (SP) in order to be available as a service for the LT-3100S GMDSS system. The Subscription status will provide the user with information whether the Voice and SMS Services are activated or not.

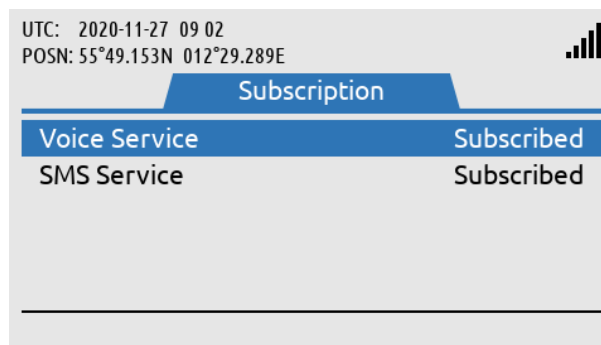

Subscription:  
MENU -> System ->  
Subscription

Figure 244: System submenu (Subscription)

**NOTE:** The Voice and SMS Service must be activated with the Iridium GMDSS Service Provider (SP). in order to be available as a service for the LT-3100S GMDSS system

System Info

The System Info provides details about the LT-3100S GMDSS system software and hardware. In addition, the following numbers are available: MSISDN (~satellite phone number), IMEI (~mobile equipment number), and ICCID (~SIM card number). The System Info is illustrated in Figure 245 and in Figure 246.

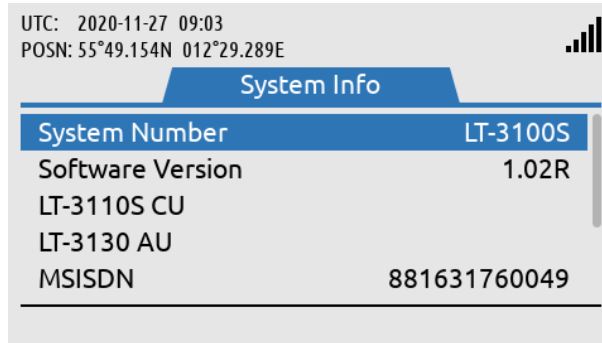

System Info:  
MENU -> System -> System Info  
(upper view)

Figure 245: System Submenu (System Info)

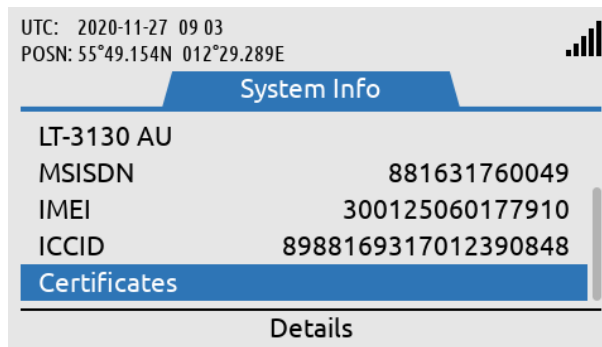

System Info:  
MENU -> System -> System Info  
(lower view)

Figure 246: System submenu (System Info)

Power Supply

The Power Supply provides details about the DC input voltage on the LT-3110S Control Unit and LT-3130 Antenna Unit.

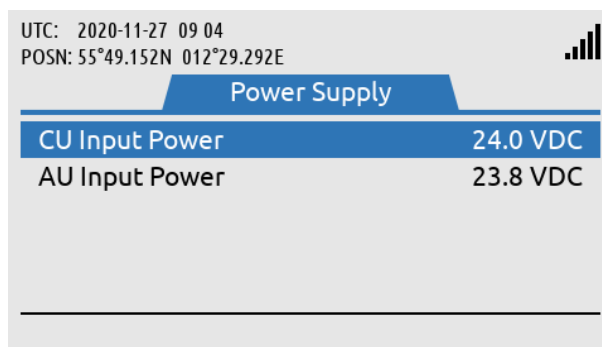

Power Supply:  
MENU -> System -> Power Supply

Figure 247: System submenu (Power Supply)

## Bridge Alert Management (BAM)

Bridge Alert Management (BAM) is the IMO defined overall concept for the harmonized management, distribution, handling and presentation of alerts on the bridge, to enable the bridge team to devote full attention to the safe operation of the ship and to immediately identify any alert situation requiring action to maintain the safe operation of the ship. The LT-3110S GMDSS system implements the BAM concept in compliance with the relevant standards (IEC 62923-1 and IEC 62923-2 Bridge Alert Management).

### BAM status

The LT-3100S GMDSS system continuously monitor for fault conditions (e.g. no satellite signal) and other events (e.g. received distress communication) that requires the attention of the bridge team and raises relevant alerts. The user can, at any time, check for the presence of alerts without performing any action: if there are one or more active alerts, a BAM icon representing the alert with the highest priority is shown in the status bar (see Figure 248). The exact icon shown depends on the priority and state of the alert with the highest priority (see Table 40 on page 149). It is not possible to hide or suppress the BAM icon in the status bar.



Figure 248: LT-3110S Control Unit (BAM status)

### Alert list

Once the user has become aware an alert has been raised, the user can navigate to the alert list (MENU -> System -> BAM Alerts) to find further information about the alert conditions.

**NOTE:** For quick access to the alert list, long press ( $\geq 1$  s) the MENU button at any time.

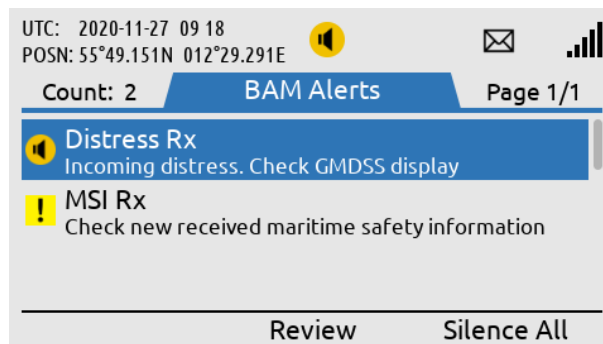

Figure 249: LT-3110S Control Unit (BAM Alert list)

See App. B - Bridge Alert Management (BAM) on page 181 for the full list of alerts that can be raised by the LT-3100S GMDSS system.

Alert priority and state

The *priority* of an alert indicates its severity. The BAM concept defines 4 priorities: Emergency Alarm, Alarm, Warning and Caution. The LT-3100S GMSDS system can raise alerts of the following priorities:

- **Warning:** Condition requiring immediate attention, but no immediate action by the bridge team. Warnings are presented for precautionary reasons to make the bridge team aware of changed conditions which are not immediately hazardous but may become so if no action is taken.
- **Caution:** Lowest priority of an alert. Awareness of a condition which does not warrant an alarm or warning condition, but still requires attention out of the ordinary consideration of the situation or of given information.

The shape and color of the BAM icon indicates the priority of the alert and the symbol inside indicates its state as per Table 40 below.







BAM Alert Icons, Priority and Stat				
Priority	Icon	State	Condition	Audible signal
Warning		Active – unacknowledged	Alert condition present. Alert not acknowledged.	Yes
		Active – silenced	Alert condition present. Alert not acknowledged, but audible signal has been silenced by the operator.	No
		Active – acknowledged	Alert condition present. Alert acknowledged by the operator.	No
		Active – responsibility transferred	Alert condition present. A function of the BAM compliant equipment with additional system knowledge has taken over.	No
		Rectified – unacknowledged	Alert condition rectified. Alert still unacknowledged.	No
	None	Normal	No alert condition present.	No
Caution		Active	Alert condition present.	No
	None	Normal	No alert condition present.	No

Table 40: BAM Alert Icons, Priority and State

### Temporary silence

Active unacknowledged alerts cause a short but periodically repeated audible signal. To temporarily silence all alerts (and thus the audible signal), press the “Silence All” soft key. The temporary silence period expires after 30 s, after which active silenced alerts become active unacknowledged alerts again, causing the audible signal to resume.

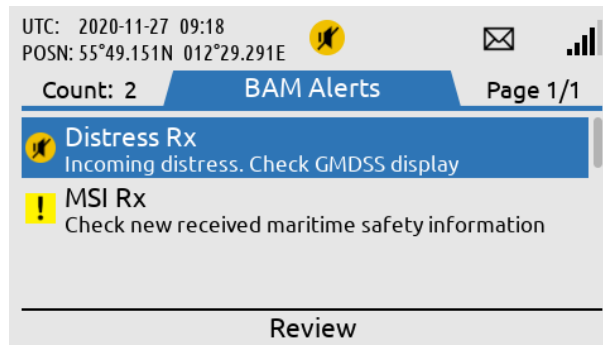

Figure 250: LT-3110S Control Unit (BAM Alerts)

**NOTE:** Active unacknowledged alerts cause a short but periodically repeated audible signal, which can be temporary silences (30 s) by pressing the soft key ‘Silence All’. This temporary silence has been illustrated in Figure 250. In this example, the active unacknowledged BAM alert can be cleared when the distress alert relay message has been read in the MSI Messages (e.g. by pressing the soft key ‘Review’).

### Alert acknowledgement

Alerts of priority warning must be acknowledged by the user. To acknowledge an alert, press the “ACK Alert” soft key.

Some alerts cannot be acknowledged by the user, in which case the “ACK Alert” soft key will be absent. This applies to alerts for which the alert text and alert description is not enough for decision support.

When an alert is both acknowledged and rectified it disappears from the alert list. Cautions cannot be acknowledged and thus disappear as soon as they are rectified.

### Aggregation

The BAM concept defines aggregation as a means for an alert source to combine multiple individual alerts of the same kind into a single aggregated header alert in order to help reduce the risk that the number of individual alerts obscures the display of equally important additional alerts, for example due to the active alert list length exceeding the maximum display capability of the alert source UI.

**NOTE:** The LT-3100S GMDSS system currently does not define any alerts that can be aggregated.

### Responsibility transfer

The BAM concept defines the Central Alert Management (CAM) system as equipment used for centralizing management, handling and presentation of alerts on the bridge. A CAM system may be standalone or combined with other equipment, for example in the case of an Integrated Navigation System (INS).

A CAM system connects to multiple alert sources (such as the LT-3100S GMDSS system) in order to manage and present their alerts on the CAM UI. An alert will thus be presented in the alert list of both the alert source and the CAM system.

To reduce the number of high-priority audible alerts for one situation that requires attention, if the CAM system has additional knowledge regarding an alert situation, which caused the LT-3100S GMDSS system to raise an alert, the CAM system may apply responsibility transfer and raising a new alert with, if practicable, a lower priority.

**NOTE:** Alerts of priority caution are not audible and therefore cannot have their responsibility transferred.

**NOTE:** The LT-3100S GMDSS will reject the request for responsibility transfer if no HBT sentence (indicating good status) has been received from the CAM system within the last 90 s.

The alert text and alert description of an alert is presented on the CAM system. For some alerts, additional information must be presented in order to allow user acknowledgement of the alert. Responsibility transfer is not allowed for such alerts as they can only be acknowledged at the alert source, where the additional information is present.

### Time synchronization

The LT-3100S GMDSS system can supply the UTC time of alert state changes to the CAM system due to the built-in GNSS receiver.

**NOTE:** If the alert state change occurs before the built-in GNSS receiver has obtained the UTC time or in case of GNSS receiver malfunctioning, the LT-3100S GMDSS system will not supply the UTC time.



## Serial Interface (RS-422)

### GNSS sentences

The LT-3100S GMDSS system support outputting of GNSS sentences encoded as NMEA 0183 via an RS-422 interface from the LT-3100S GMDSS system, as illustrated in Figure 251. The LT-3100S GMDSS system has a built-in GNSS receiver in the LT-3130 Antenna Unit.



Figure 251: GNSS sentences

Table 41 presents the supported GNSS sentences by the LT-3100S GMDSS system. The configuration of the GNSS sentences are illustrated and described in *GNSS, BAM and MSI* on page 171.

GNSS Sentences			
Sentence	Baud Rate		
	4.800	9.600	38.400
DTM	X	X	X
GGA	X	X	X
GLL	X	X	X
GSA	X	X	X
GSV	-	X	X
RMC	X	X	X
VTG	X	X	X
ZDA	X	X	X

Table 41: GNSS sentences

**IMPORTANT:** The GNSS receiver of the LT-3100S GMDSS system is not certified according to IMO performance standards for GNSS receivers. The LT-3100S GMDSS system shall not be connected to equipment where the GNSS receiver interface must be certified.

The GNSS sentences and decoding of these are further documented in *App. D - GNSS sentences* on page 191.

**BAM sentences**

The LT-3100S GMDSS system support connection to an external Central Alert Management (CAM) system via an RS-422 interface from the LT-3100S GMDSS system, as illustrated in Figure 252. The CAM system can receive BAM information (e.g. warning and cautions) from the bridge equipment and centralize and present this information to the user, which can be acknowledged to the BAM equipment (here the LT-3100S GMDSS system).

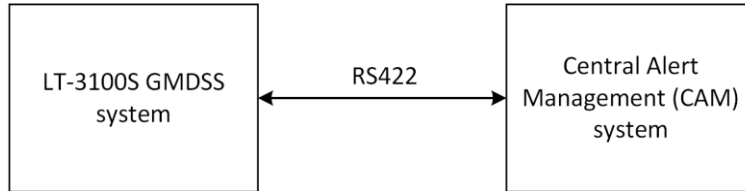

Figure 252: CAM/BAM system

Table 42 presents the supported BAM sentences by the LT-3100S GMDSS system. The configuration of the BAM sentences are illustrated and described in *GNSS, BAM and MSI* on page 171.

Sentences Received by SES		
Sentence	Name	Comment
ACN	Alert Command	Alert command for instance acknowledge
HBT	Heartbeat	Support reliable alert related communication
Sentences Transmitted by SES		
Sentence	Name	Comment
ARC, ALC, ALF	Alert information	

Table 42: BAM sentences

**NOTE:** The encoding of BAM sentences is defined in IEC 61162-1 (Edition 5.0, 2016-08), the encoding is similar to NMEA 0183.

The BAM sentences and decoding of these are further documented in App. E - BAM sentences on page 193.

**MSI sentences**

The LT-3100S GMDSS system supports connection to an external ECDIS system via an RS-422 interface from the LT-3100S GMDSS system, as illustrated in Figure 253. The MSI sentences are transmitted from the LT-3100S GMDSS system as ‘information only’. The MSI messages transmitted from the Iridium GMDSS System (IGS) must always be read via the LT-3110S Control Unit UI display (MSI messages cannot be marked/acknowledged via the external ECDIS system receiving these MSI messages).

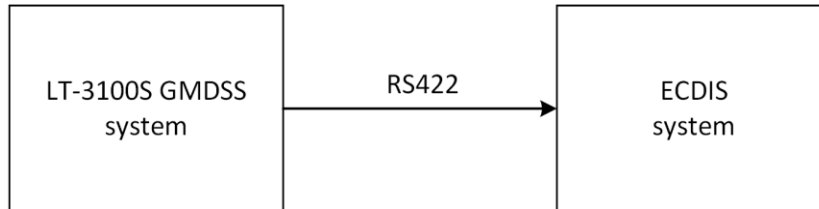

Figure 253: MSI sentences

Table 43 presents the supported MSI sentences by the LT-3100S GMDSS system. The configuration of the MSI sentences are illustrated and described in *GNSS, BAM and MSI* on page 171.

Sentences Transmitted by the SES		
Sentence	Name	Comment
SM1, SM2, SM3, SM4, SMB, SMV	Maritime Safety Information (MSI)	

Table 43: MSI sentences

**NOTE:** The encoding of MSI sentences is defined in the IEC-61097-16 (Edition 1.0 2019-07) standard, the encoding is similar to NMEA 0183.

The MSI sentences and decoding of these are further documented in *APP. F - MSI sentences* on page 195.

## GMDSS Printers

The LT-3100S GMDSS system support connection of an external GMDSS printer. The GMDSS printer must be connected via the LT-3140S interface Unit and use the proprietary LT-3160S Printer Adapter from Lars Thrane A/S. The LT-3160S Printer Adapter is connecting to the GMDSS printer via a Centronics interface, 36 pins (IEEE Std 1284-2000, 1284-B receptacle connector). The LT-3160S Printer Adapter is connected to the LT-3140S Interface Unit, using the interface marked 'Printer'. The LT-3160S Printer Adapter is powered from the LT-3140S Interface Unit.

The LT-3100S GMDSS system can print the International Reference Alphabet (IRA) character set (also known as IA5 or T.50).

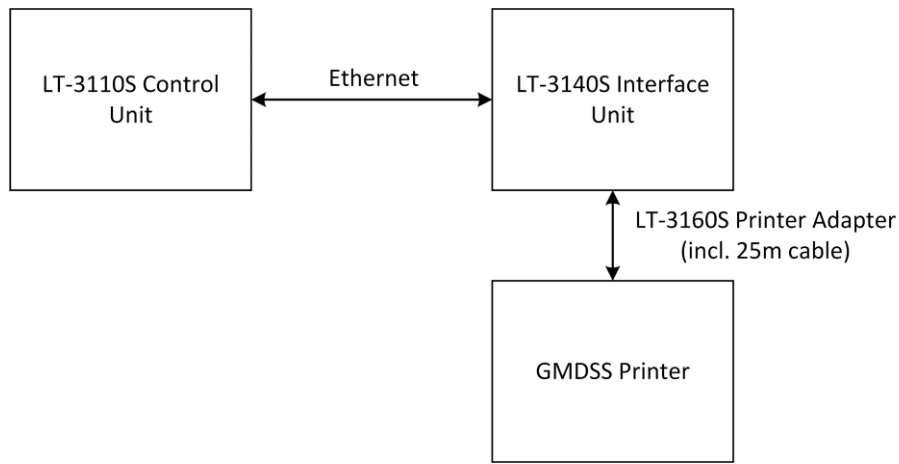

Figure 254: Connect a GMDSS Printer

The GMDSS printer will be detected when running the Installation Wizard, see *Installation Wizard* on page 57. If the GMDSS printer is added after completion of the Installation Wizard, then the Service Wizard will detect the GMDSS printer and complete the setup.

The LT-3100S GMDSS system is supporting the GMDSS printers listed in Table 44.

GMDSS Printers	
Manufacturer	Model No.
Furuno	PP-520
JRC	NKG-900
Cobham SAILOR	H1252B/TT-3608A

Table 44: GMDSS Printers Supported

**NOTE:** The LT-3100S GMDSS system will generate a BAM alert, if the GMDSS printer is running out of paper, see BAM alerts in *App. B - Bridge Alert Management (BAM)* on page 181.

**NOTE:** Accordingly, to the new GMDSS standard IEC 61097-16, it is no longer a requirement to have a GMDSS printer as part of the GMDSS Satcom installation.

## Web server

The LT-3110S Control Unit has a built-in webserver, which can be accessed from the Ethernet (RJ45) interface from the back side of the control unit. A PC must be connected to the control unit, either directly by connecting an Ethernet cable between a PC and the LT-3110S Control Unit, or by connecting the LT-3110S Control Unit to a Local Area Network (LAN), to where the PC is connected.

**NOTE:** The IP address allocated to the LT-3110S Control Unit, is shown in the GUI (Menu -> System -> Network: IP Address).

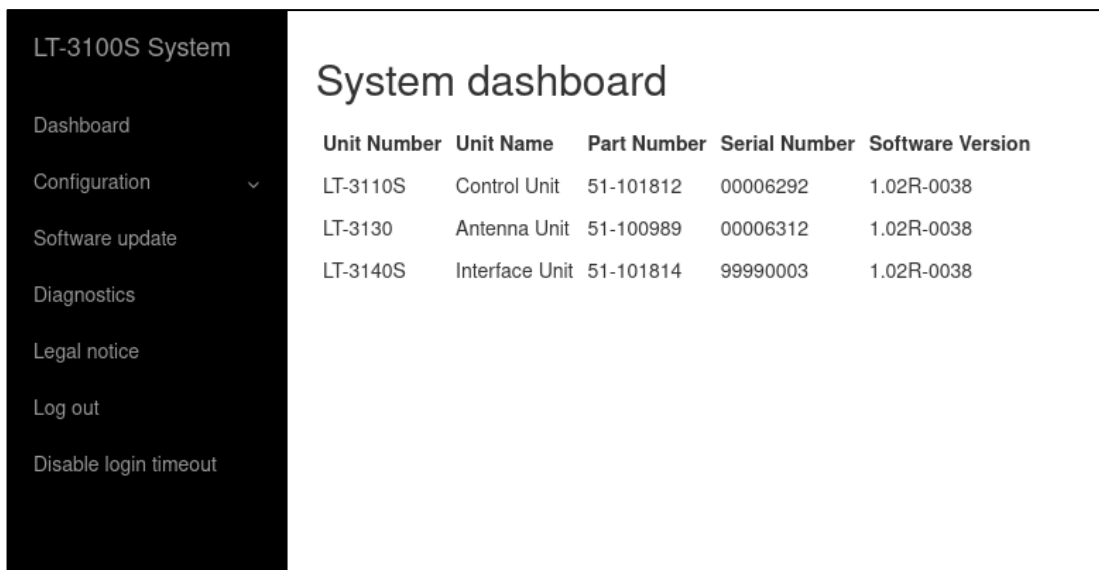

Figure 255: Web server (System dashboard)

The functionality of all web pages is described in further detail in the following sections. Some of the sections will refer to other sections in this User & Installation Manual, e.g. hardware interfaces.

**NOTE:** All web pages functionality will be described in detail for the LT-3100S GMDSS system. It is the intention that the web pages should be used during the installation and configuration of the system. During normal operation of the system, it shouldn't be necessary to access the web pages.

## Accessing the built-in web server

To access the built-in web server of the LT-3100S GMDSS system, please complete the following steps:

1. Connect the LT-3110S Control Unit directly to a PC using an Ethernet cable, or connect the LT-3110S Control Unit to a Local Area Network (LAN), where a PC is connected. If the LT-3140S Interface Unit is connected to the LT-3110S Control Unit, then use one of the spare Ethernet ports on the LT-3140S Interface Unit, which will behave as a Layer 2 Ethernet (network) Switch.
2. Identify the IP address that is assigned to the LT-3110S Control Unit. The IP address can be read out from the display (MENU -> System -> Network: IP Address). The IP address is valid if the 'Link Status' is showing 'Up'. The IP address is assigned dynamically by a DHCP server.
3. From the PC, start a browser (e.g. Microsoft Edge, Explorer, Chrome, etc.) and type in the IP address, which was identified in the LT-3110S Control Unit (e.g. 169.254.1.1).
4. The browser might show you a warning about an invalid web server certificate, as illustrated in Figure 256. Make sure, that you have typed in the correct IP address.
5. Press 'Details' and you will be presented for an extended page view (including a link), which will direct you to the LT-3100S GMDSS system dashboard 'Go on to the webpage (Not recommended)'.
6. You will now see the LT-3100S GMDSS system dashboard.

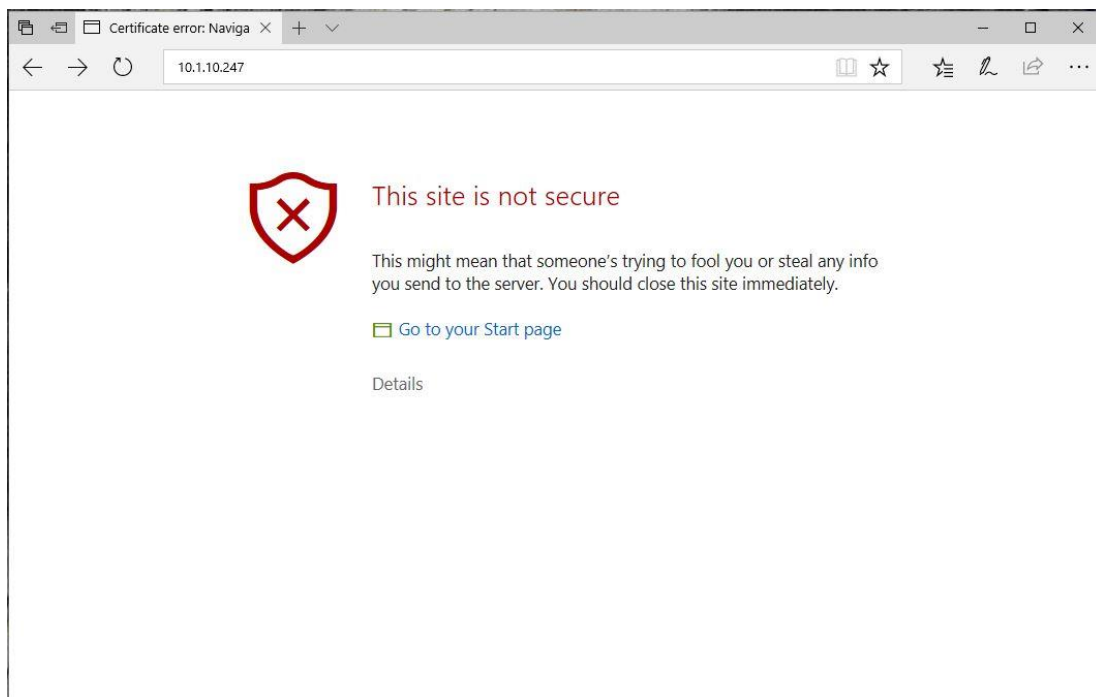
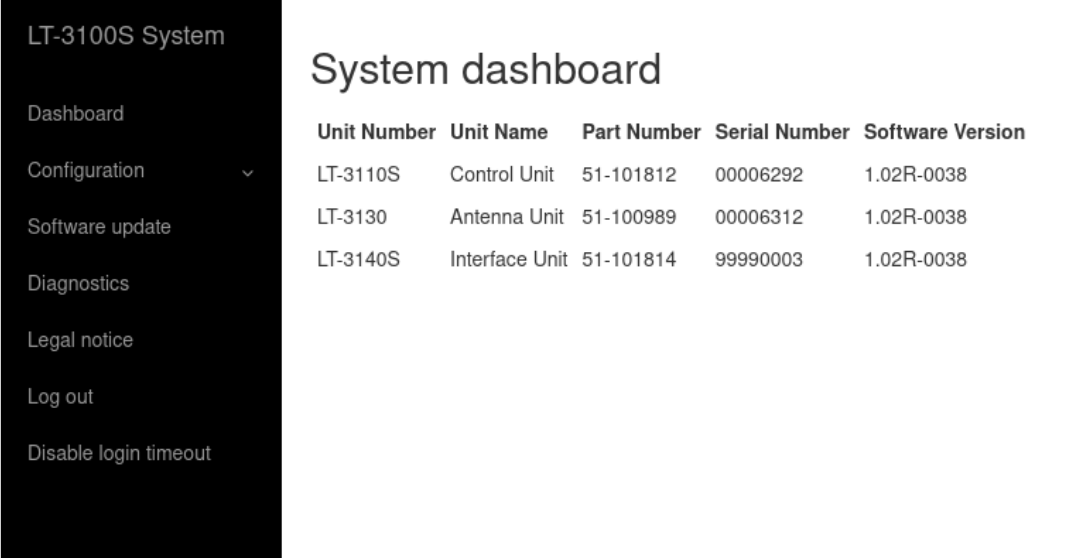

Figure 256: Accessing the built-in web server ("This site is not secure").

## Dashboard

The dashboard is showing details about the main units, which forms the satcom system: the LT-3110S Control Unit, LT-3130 Antenna Unit, LT-3140S Interface Unit, LT-3150S Alarm Panel, and LT-3160S Printer Adapter. If the units are connected correctly to the control unit, then the units will be visible on the web server dashboard, as illustrated in Figure 257. Otherwise, only the control unit will be visible. For each unit, the following information will be available: unit number, unit name, unit part number, unit serial number, and software version. The antenna unit, interface unit, alarm panels, and printer adapter will automatically be updated with the software installed in the control unit.



The screenshot shows the 'System dashboard' for the LT-3100S system. On the left is a dark sidebar with navigation options: Dashboard, Configuration (with a dropdown arrow), Software update, Diagnostics, Legal notice, Log out, and Disable login timeout. The main content area displays a table with the following data:

Unit Number	Unit Name	Part Number	Serial Number	Software Version
LT-3110S	Control Unit	51-101812	00006292	1.02R-0038
LT-3130	Antenna Unit	51-100989	00006312	1.02R-0038
LT-3140S	Interface Unit	51-101814	99990003	1.02R-0038

Figure 257: Web server (System dashboard)

The web server has the following webpages:

- Dashboard
- Configuration (*contains subpages*)
- Software update
- Diagnostics
- Legal notice
- Log out

### Configuration

The LT-3100S GMDSS system is initially configured and fully operational after the Installation Wizard has been completed. The Installation Wizard is described and illustrated in *Installation Wizard* on page 57. Additionally, the GMDSS settings can be configured via the GMDSS submenu, as described in *GMDSS Submenu* on page 93. In this section there will be a description of system settings, which is not covered by the Installation Wizard and the LT-3110S Control Unit display menu layout.

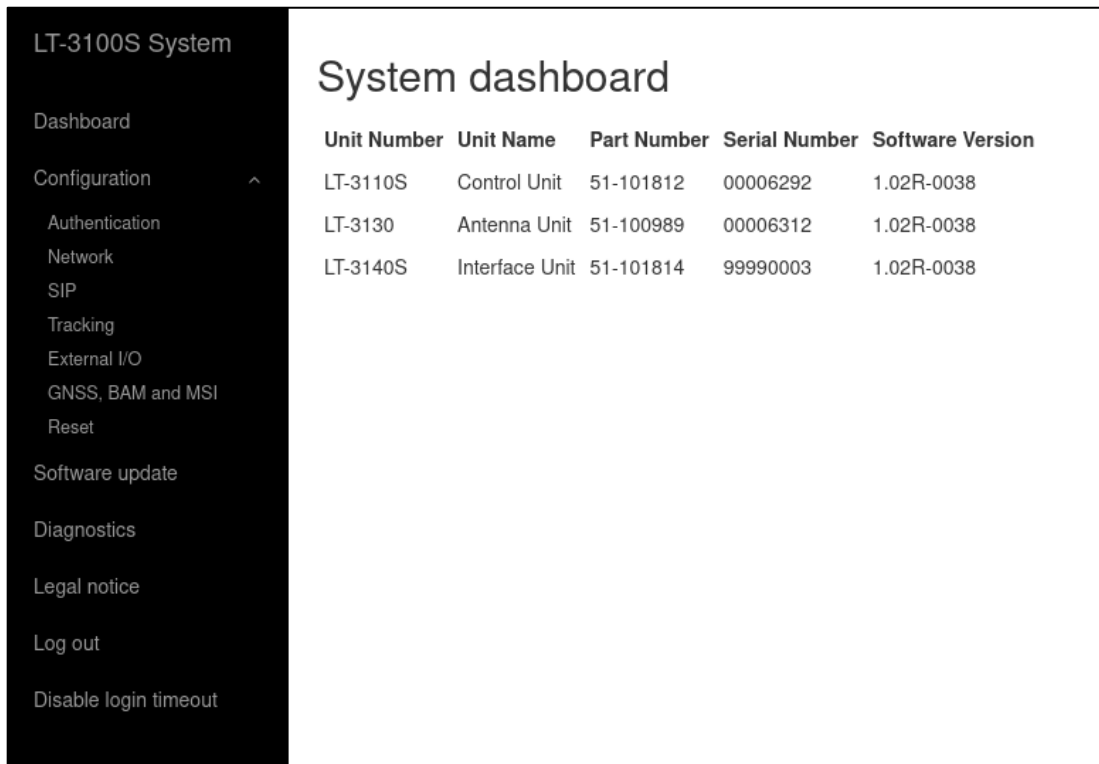

Figure 258: Web server (Configuration)

Under Configuration, the following webpages are available:

- Authentication
- Network
- SIP
- Tracking
- External I/O
- GNSS, BAM and MSI
- Reset



**Authentication**

The LT-3100S GMDSS system support configuration of authentication on the web server.

The default password for the User = admin and Password = admin. The LT-3100S GMDSS system will always be delivered from Lars Thrane A/S with the default password configured.

**NOTE:** It is highly recommended that the installer of the LT-3100S GMDSS system changes the default password during the installation of the system, so that a random user on the network does not have access to the web server.

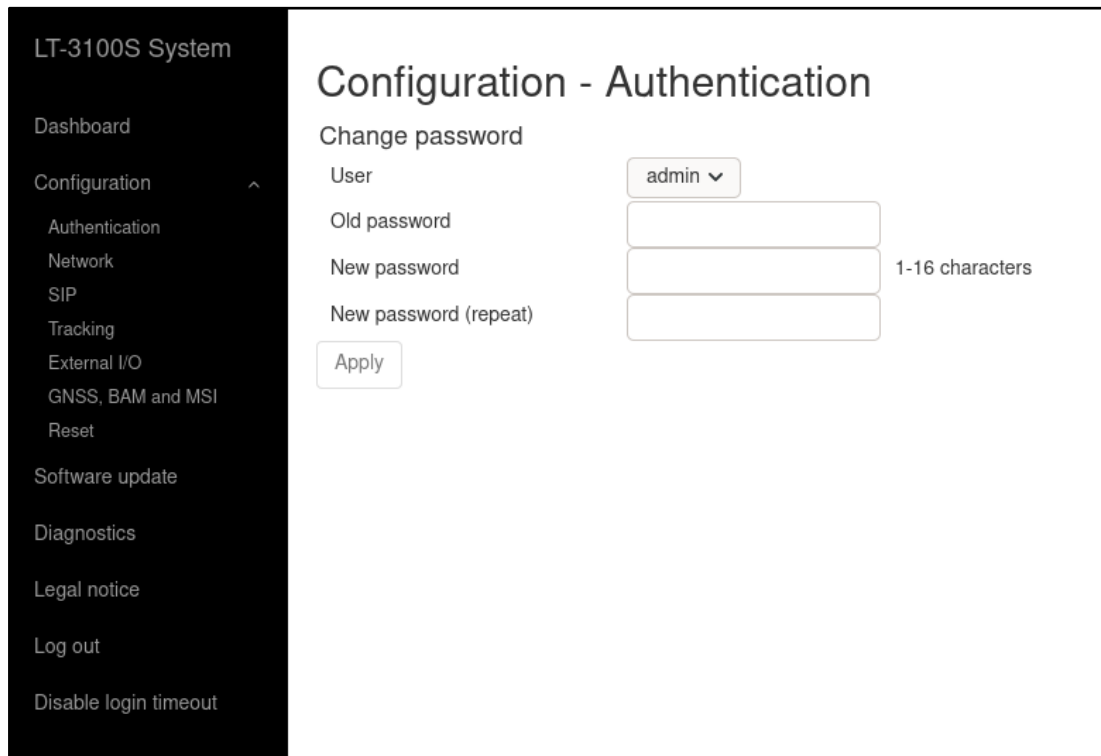

Figure 259: Web server (Authentication)

If the authentication password is changed from default and forgotten, then the authentication password can be reset from the display (MENU -> Settings -> Reset Options: Reset Web Authentication). Remember to change the authentication password away from the default password, as soon as it has been possible to re-enter the web server. The Reset Web Authentication is further described and illustrated in *Settings* on page 139.

## Network

The LT-3100S GMDSS system is supporting the most common network configurations for Local Area Network (LAN). The LT-3100S GMDSS system has one Ethernet (RJ45) interface, which is described in *Ethernet RJ45 (LAN)* on page 32.

The following network configuration modes will be described in this section:

- DHCP client
- DHCP server
- Static

The default network configuration mode for the Ethernet interface is DHCP client.

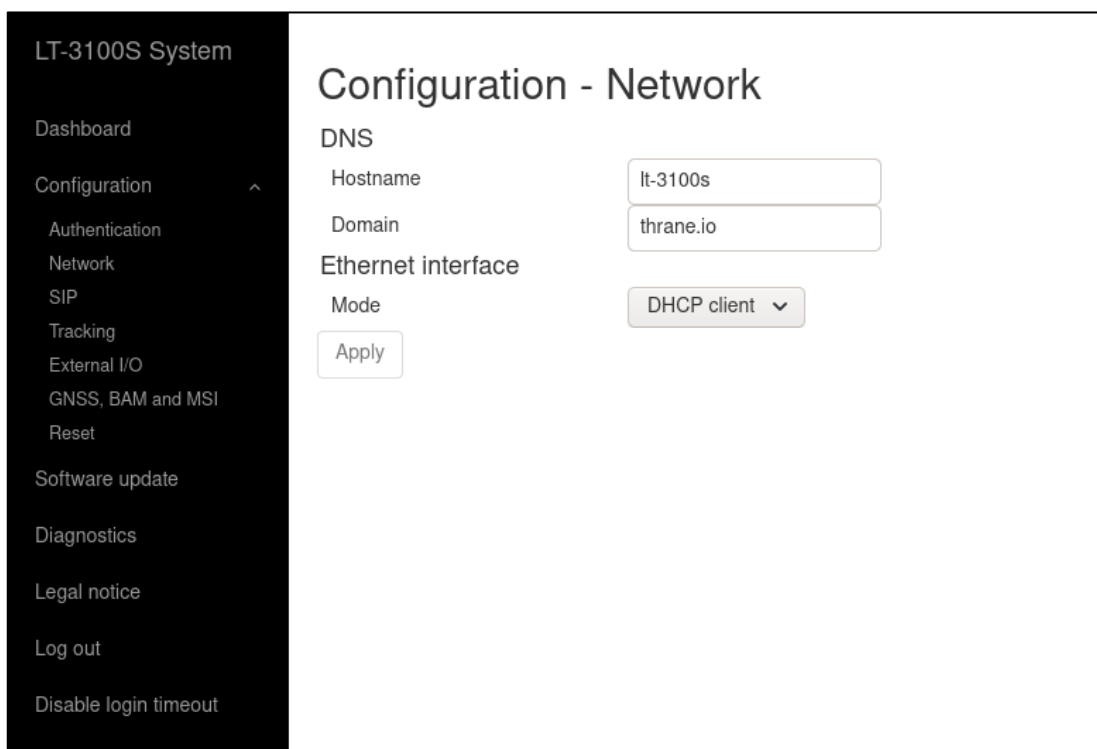

Figure 260: Web server (Network - DHCP client)

**NOTE:** In DHCP client mode, Link-local is supported, in order to connect another 'passive' IP-device (e.g. a PC) directly to the LT-3110S Control Unit. Expect the LT-3110S Control Unit to get the IP-address: 169.254.1.1.

**NOTE:** The IP-address of the LT-3110S Control Unit is always available from the display (MENU -> System -> Network), see details in *System* on page 143. If the LT-3110S Control Unit is starting up showing the Installation Wizard, then make a short press on the MENU button and details will be available (incl. the IP Address of the control unit).

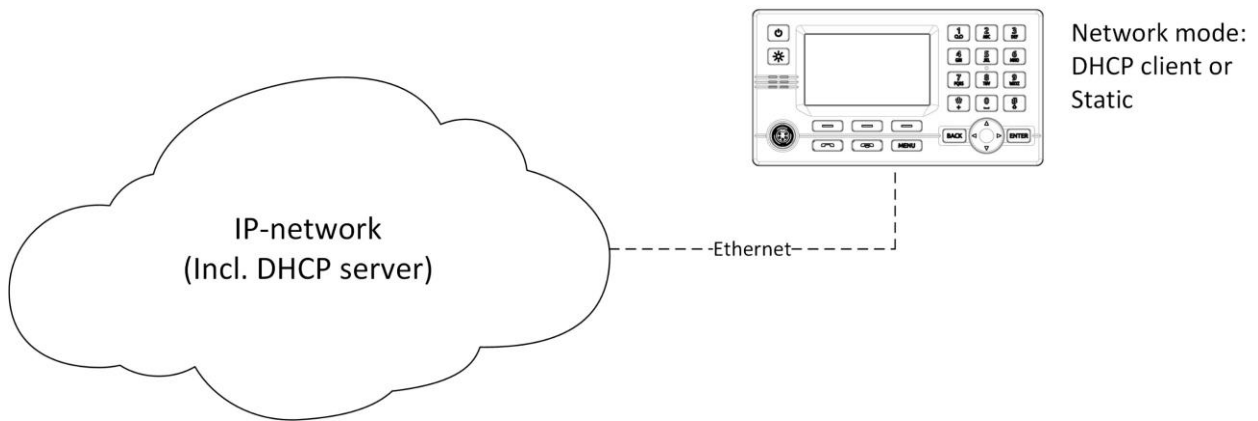

Figure 261: LT-3100S GMDSS System and IP Network

If the LT-3100S GMDSS system is connected to a local network as illustrated in Figure 261, where a DHCP server is already available, then the LT-3100S GMDSS system must be configured to either DHCP client or Static mode. The Static mode can be used, if it is required that the IP-address of the LT-3110S Control Unit must never change.

The LT-3100S GMDSS system has two reserved network ranges, which are documented in Table 45.

Reserved Network Ranges	
Reserved	Sub-nets
Reserved External	192.168.255.0/24 - i.e. 192.168.255.0 netmask 255.255.255.0
Reserved Internal	172.27.0.0/16 - i.e. 172.27.0.0 netmask 255.255.0.0

Table 45 Reserved Network Ranges

**NOTE:** The LT-3140S Interface Unit contains a 4-port Layer 2 Ethernet (network) Switch. When an LT-3140S Interface Unit is connected to the LT-3110S Control Unit, then it is possible to use one of the three remaining Ethernet (RJ45) ports to connect to an external IP network. The LT-3140S Interface Unit will behave as a passive network switch between the LT-3110S Control Unit and the external IP network.

**IMPORTANT:** Do not connect the LT-3100S GMDSS System to any external IP networks, which are not trusted. The LT-3110S Control Unit and LT-3140S Interface Unit both have Firewall rules configured on all Ethernet ports to avoid unwanted IP traffic.

DHCP client

The DHCP client mode is the configuration of the LT-3110S Control Unit from the factory. The DHCP client mode must be used, if the IP network already has a DHCP server available.

DHCP Server

The DHCP server mode must be used when connecting the LT-3110S Control Unit directly to another IP-device or local network, where no DHCP server is offered, and where it is required that a DHCP server is offered for assigning IP addresses to network clients. The web server DHCP server mode setting is illustrated in Figure 262.

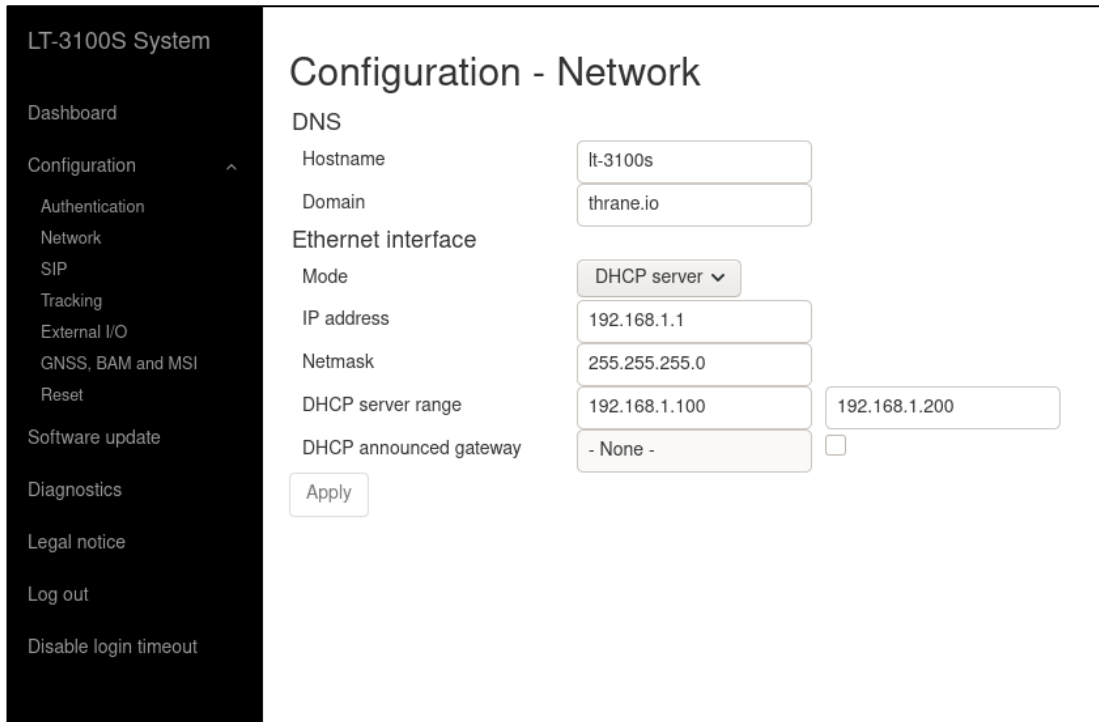

Figure 262: Web server (Network - DHCP server)

**NOTE:** A user scenario for configuration the DHCP server mode is when e.g. connecting IP-based communication devices: Analogue Phone Adapter or SIP Phones directly to the LT-3110 Control Unit via the Ethernet interface. Connecting an Analogue Phone Adapter is further described in *Analogue Phone Adapter* on page 133.

Static

The Static mode must be used when the IP address of the LT-3110 Control Unit must never change. Typically used, if connecting the LT-3110 Control Unit to an IP network, where a DHCP server is already available, and where it is important that the IP address assigned for the LT-3110 Control Unit is never changed.

**SIP**

The LT-3100 System has a built-in PBX trunk (SIP), which support internal and external satellite calling. The LT-3100 system only supports 1 x Iridium satellite voice channel. The PBX trunk (SIP) can be accessed via Ethernet, RJ45. Up to 8 external SIP devices can be registered in the PBX trunk. The web server, Configuration - SIP is illustrated in Figure 263.

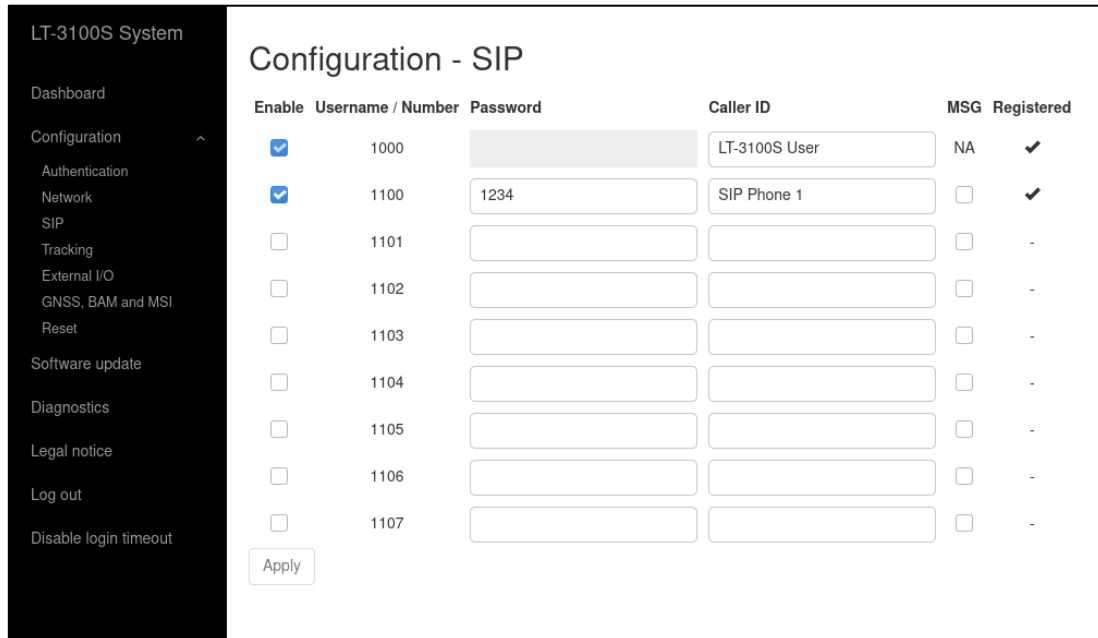

Figure 263: Web server (SIP)

In the LT-3110S Control Unit display (MENU -> System -> SIP) it is possible to get an actual status of the number of SIP devices and their registration status. This is further illustrated and described in *System* on page 143.

The following external applications requires a SIP configuration:

- Connection of ships PBX
- External SIP Phones
- External Analogue Phone Adapter
- SIP Softphones via external Wi-Fi Access Point (WAP)

**NOTE:** External SIP phones and registered SIP devices can only initiate and receive voice calls (priority = routine). If an external SIP phone is in an active voice call, then a dedicated symbol will be shown in the status bar (see Table 18 on page 49). A Safety Call will always preempt the voice call (priority = routine).

An incoming voice call (priority = routine) to the LT-3100S GMDSS system, will be signaled to all external SIP devices. The first SIP devices or LT-3120 Handset answering the incoming voice call will be connected. The LT-3100S GMDSS system is currently not supporting call forwarding.

**Tracking**

The LT-3100S GMDSS system is supporting tracking (position reporting) using different transport types and report formats. This section will briefly describe the different Tracking configurations options. For more details on Lars Thrane A/S tracking protocol supported in the LT-3100S GMDSS system, please get in contact with Lars Thrane A/S. Figure 264 is illustrating the web server, configuration - tracking.

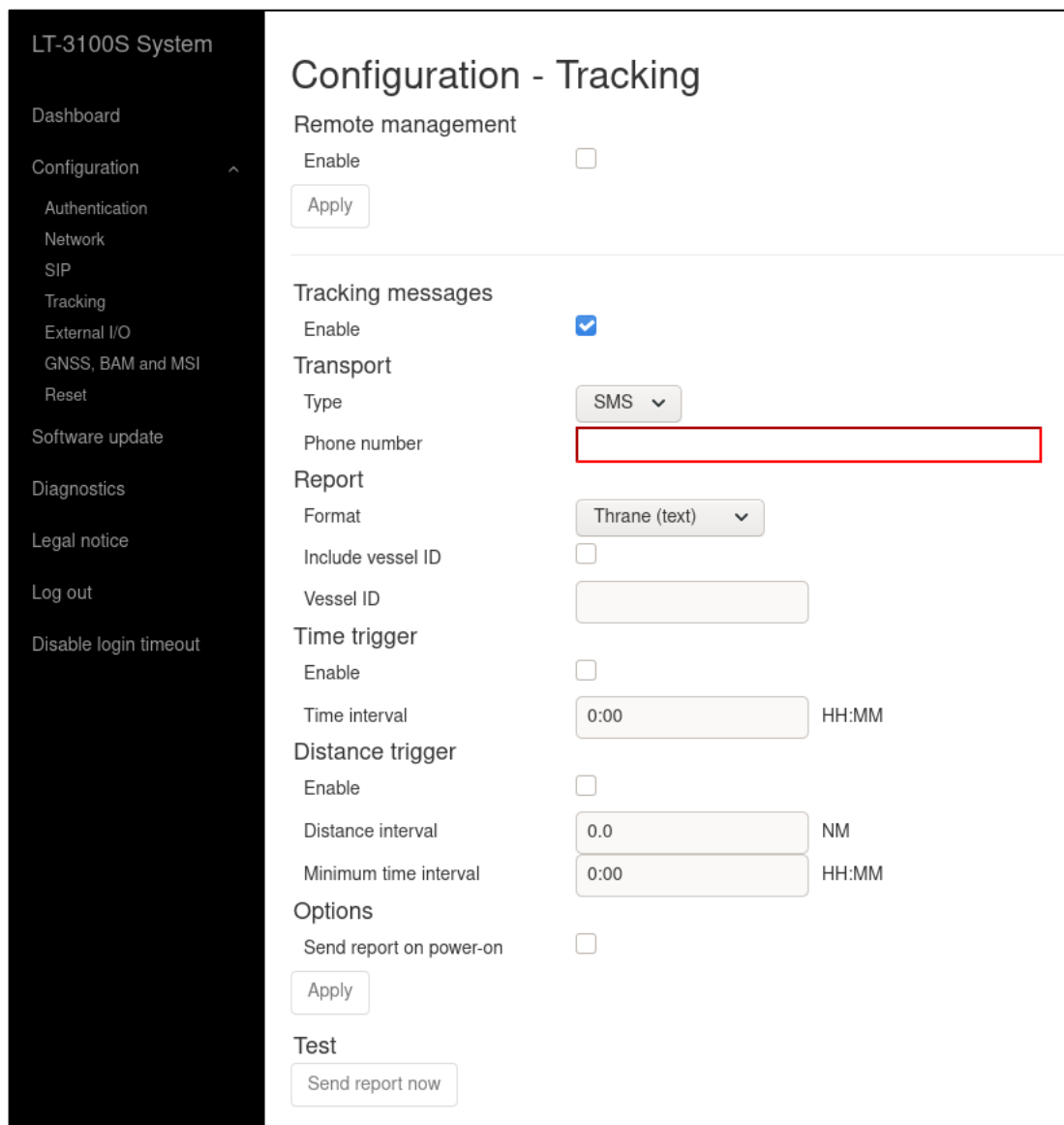

Figure 264: Web server (Tracking)

The tracking transport types, and report formats currently supported in the LT-3100S GMDSS system are summarized in Table 46.

Transport Types & Report Formats		
Transport Type	Report Format	Comments
SMS	Thrane (text)	Text format to be used for machine reading and decoding
	Human readable	Text format to be used for human reading
E-mail	Thrane (text)	Text format to be used for machine reading and decoding
	Human readable	Text format to be used for human reading

Table 46: Web server - Tracking (transport types and report formats)

**NOTE:** Lars Thrane A/S has an Interface Control Document (ICD) with details describing the following content: binary and text formats, remote management (configuration, requesting position report, and trigger position report). In order to support the Thrane (binary) format it is a requirement to get access to this ICD. The SBD binary format is not supported in the LT-3100S GMDSS system.

The trigger configuration options and intervals are summarized in Table 47.

Trigger Configurations			
Trigger	Format	Interval	Comments
<b>Time</b>			
Time interval	HH:MM	0:01 to 168:00	Time can be configured from 0.01 (1 minute) to 168:00 (up to 7 days)
<b>Distance</b>			
Distance interval	NM	0.1 to 999	Distance can be configured from 0.1 to 999 NM
Minimum time interval	HH:MM	0:01 to 168:00	Minimum time can be configured from 0.01 (1 minute) to 168:00 (up to 7 days)

Table 47: Web server (Tracking - trigger configurations)

The time and distance trigger conditions can be configured individually. A tracking report will be sent, when a trigger condition has been met - time and/or distance. The trigger algorithm will 'reset' every time a tracking report has been sent.

The time trigger condition can be configured from 1 minute (0:01) and up to 7 days (168:00). The distance trigger condition can be configured from 0.1 NM and up to 999.0 NM. For the distance trigger condition, it is possible to configure a Minimum time interval, which has the purpose to make sure that not too many tracking reports are sent.

Example: If the distance interval is configured to 5.0 NM and Minimum time interval is configured to 01:00 hour, then position reports will be sent, when both requirements have been met (maximum every 1 hour). If the speed over ground is < than 5 knots, then a tracking report will be sent every 5.0 NM. If the speed over ground is > 5 knots, then a tracking report will be sent every 1 hour.

Under Options - Send report on power-on it is possible to configure the LT-3100S GMDSS system to send a tracking report every time the terminal is powered on.

Use the button 'Send report now', illustrated in Figure 264 on page 165, to overwrite the tracking algorithm and send a tracking report instantly. Also, use the button to test the format of the tracking reports after tracking configurations have been applied.

**NOTE:** The LT-3110S Control Unit display has a tracking window (MENU -> System -> Tracking), providing tracking status overview. From this tracking window, it is possible to initiate a periodic tracking report (if configured) or initiate a tracking message, which will be sent to either an SMS or E-mail destination. For further details see *Tracking* on page 135.

**SMS**

The LT-3100S GMDSS system supports SMS as transport type for tracking reports, see configuration options in Figure 265. The SMS tracking is supporting two formats: ‘Thrane (text)’ and ‘Human readable’.

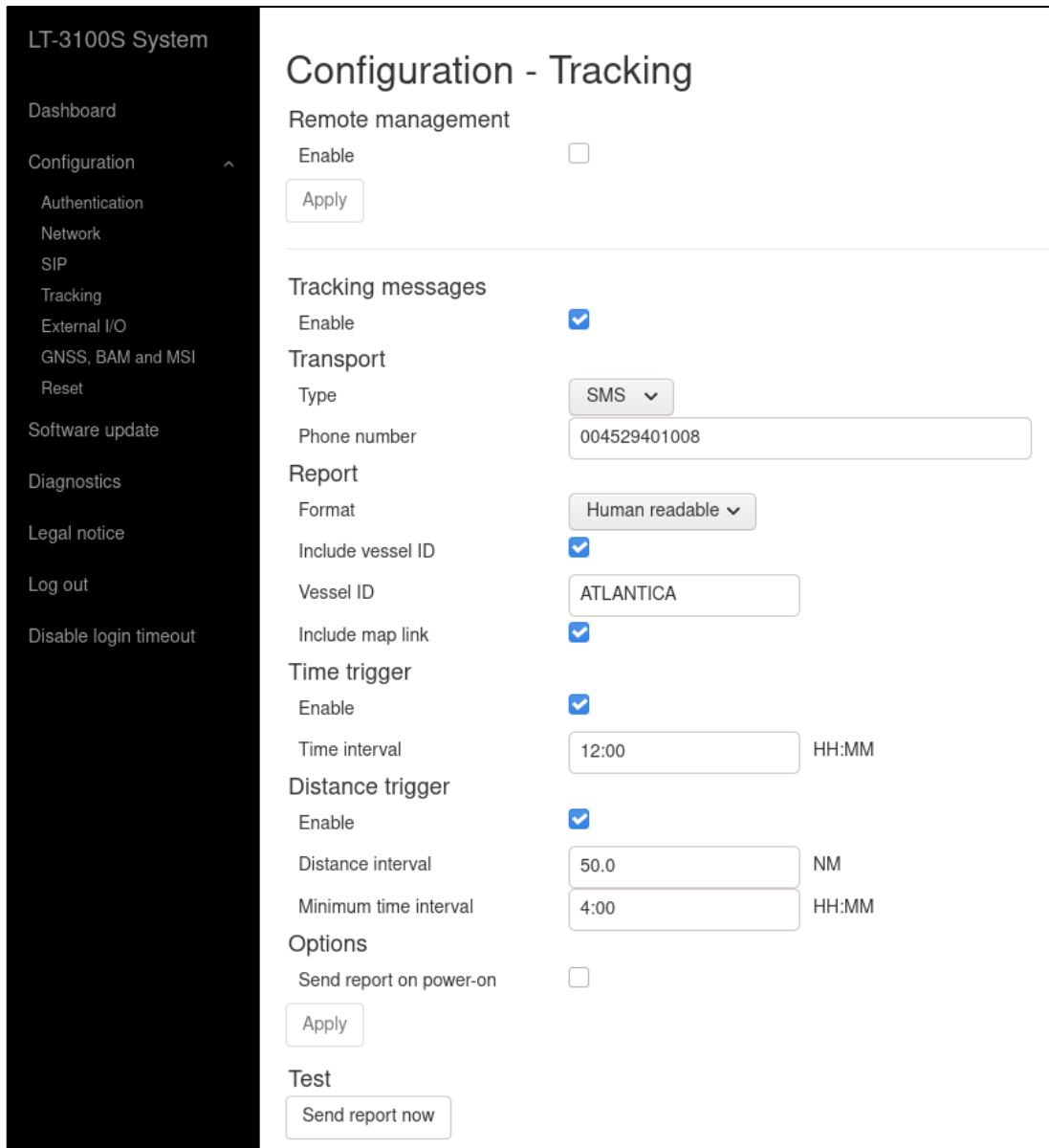

Figure 265: Web server (Tracking - SMS)

The format of a tracking report ‘Human readable’ sent to e.g. a smartphone is illustrated in Figure 266.

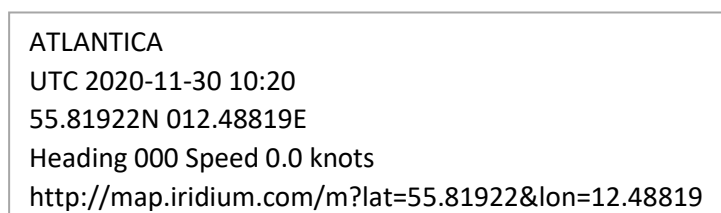

Figure 266: Tracking Report (SMS - Human Readable)



E-mail

The LT-3100S GMDSS system supports E-mail as transport type for tracking reports, see configuration options in Figure 267. The E-mail tracking is supporting two formats: ‘Thrane (text)’ and ‘Human readable’.

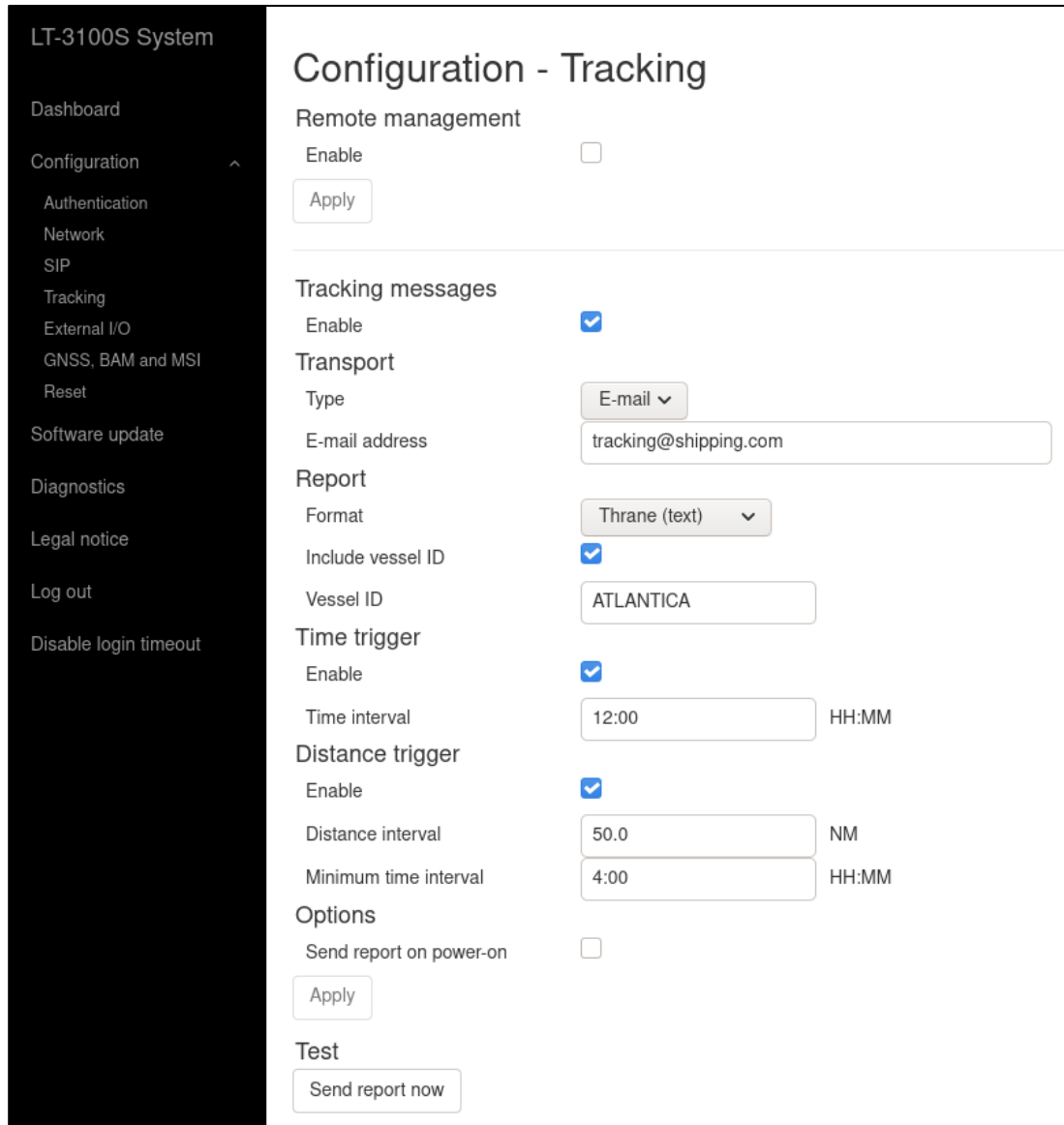

Figure 267: Web server (Tracking - E-mail)

The format of a tracking report ‘Thrane (text)’ sent to an E-mail address is illustrated in Figure 268.

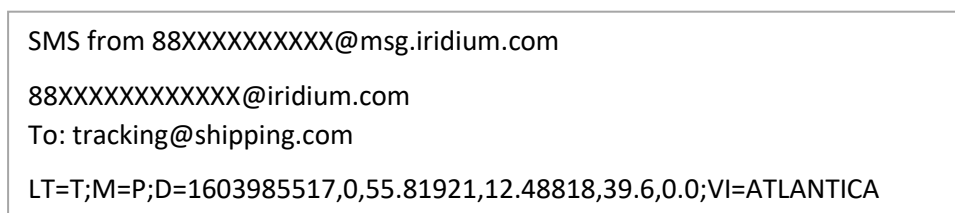
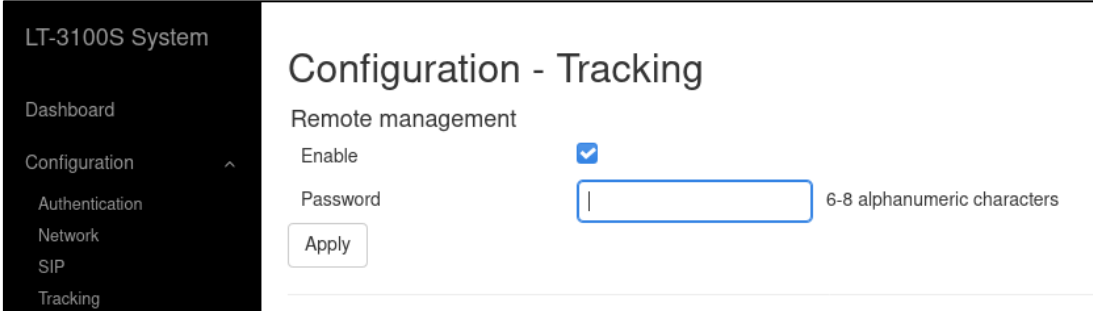

Figure 268: Tracking Report (E-mail - Thrane (text))

## Remote management

The LT-3100S GMDSS system support Remote Management for the tracking application. In order for the Remote Management to work, the Remote Management must be enabled by the user and a password must be chosen as illustrated on Figure 269. The Remote Management is using the General Messaging (~SMS) service as communication layer.



The screenshot shows the 'Configuration - Tracking' page in the LT-3100S System web interface. The sidebar on the left lists navigation options: Dashboard, Configuration (expanded), Authentication, Network, SIP, and Tracking. The main content area is titled 'Configuration - Tracking' and contains a 'Remote management' section. In this section, the 'Enable' checkbox is checked. Below it is a 'Password' field with a blue border and a placeholder character '|', followed by the text '6-8 alphanumeric characters'. An 'Apply' button is located below the password field.

Figure 269: Web server (Tracking - Remote Management)

The Tracking Remote Management functionality is supporting:

- Request Position Report
- Trigger Position Report
- Change Tracking Configuration

**NOTE:** For further details about the Remote Management functionality, please contact Lars Thrane A/S.

**External I/O**

The LT-3100S GMDSS system supports configuration of External I/O. The LT-3100S GMDSS system has one input and one output supported in the AUX connector. The AUX connector is described in *Auxiliary (AUX)* on page 33. Figure 270 is illustrating the configuration of the External I/O.

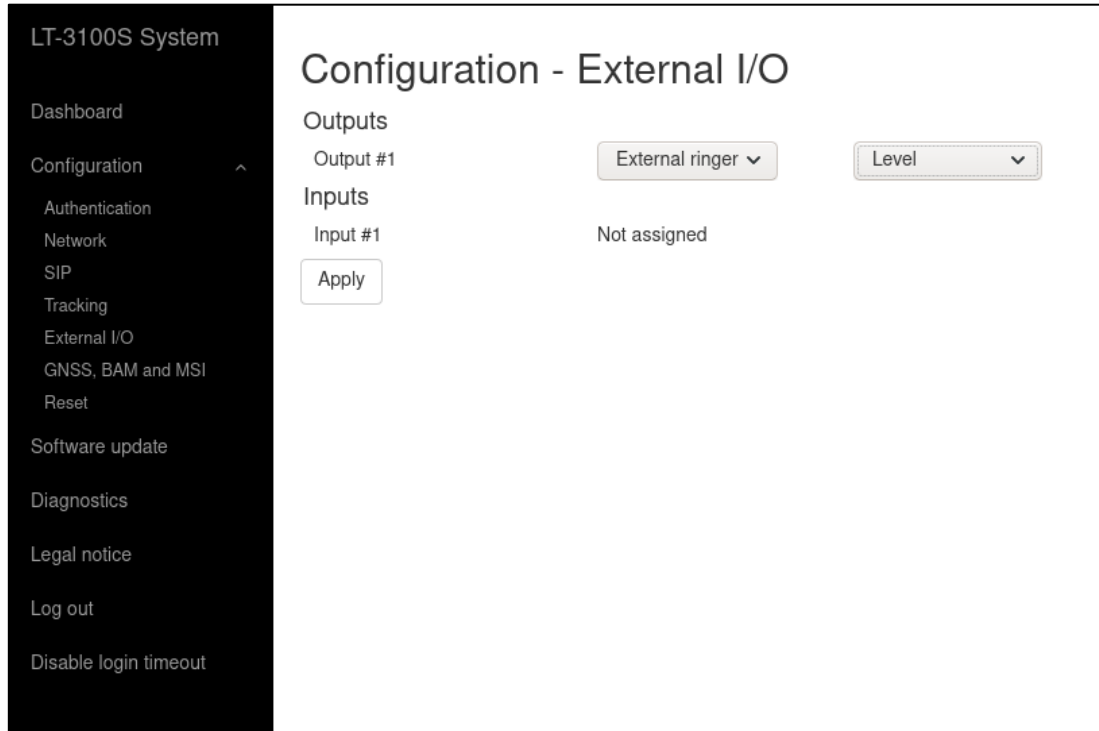

Figure 270: Web server (External I/O)

Output

The External I/O output configuration options are listed in Table 48.

External I/O - Output Configuration	
Not assigned	default
External ringer	Level
	Pulse @ 0.5 Hz
	Pulse @ 1 Hz
	Pulse @ 2 Hz

Table 48: External I/O (Output)

Input

The LT-3100S GMDSS system is currently not supporting any functionality for the External I/O input.

**GNSS, BAM and MSI**

The LT-3100S GMDSS system has a built-in GNSS receiver located in the LT-3130 Antenna Unit. The GNSS receiver is used for time, date and position of the LT-3100S GMDSS system, for example used for position reporting in connection with sending a Distress Alert message or used by the tracking application. The GNSS receiver can be configured to operate on different satellite systems (e.g. GPS only) - this can be managed under the GNSS module, as illustrated in Figure 271.

It is possible to configure the following functionality: GNSS, BAM and MSI on the LT-3110S Control Unit (CU - AUX) and LT-3140S Interface Unit (IU - Port 1 and IU - Port 2) interfaces respectively.

This section is describes the following configuration options:

- GNSS module
- GNSS (output of NMEA 0183 sentences)
- Bridge Alert Management (BAM)
- Maritime Safety Information (MSI)

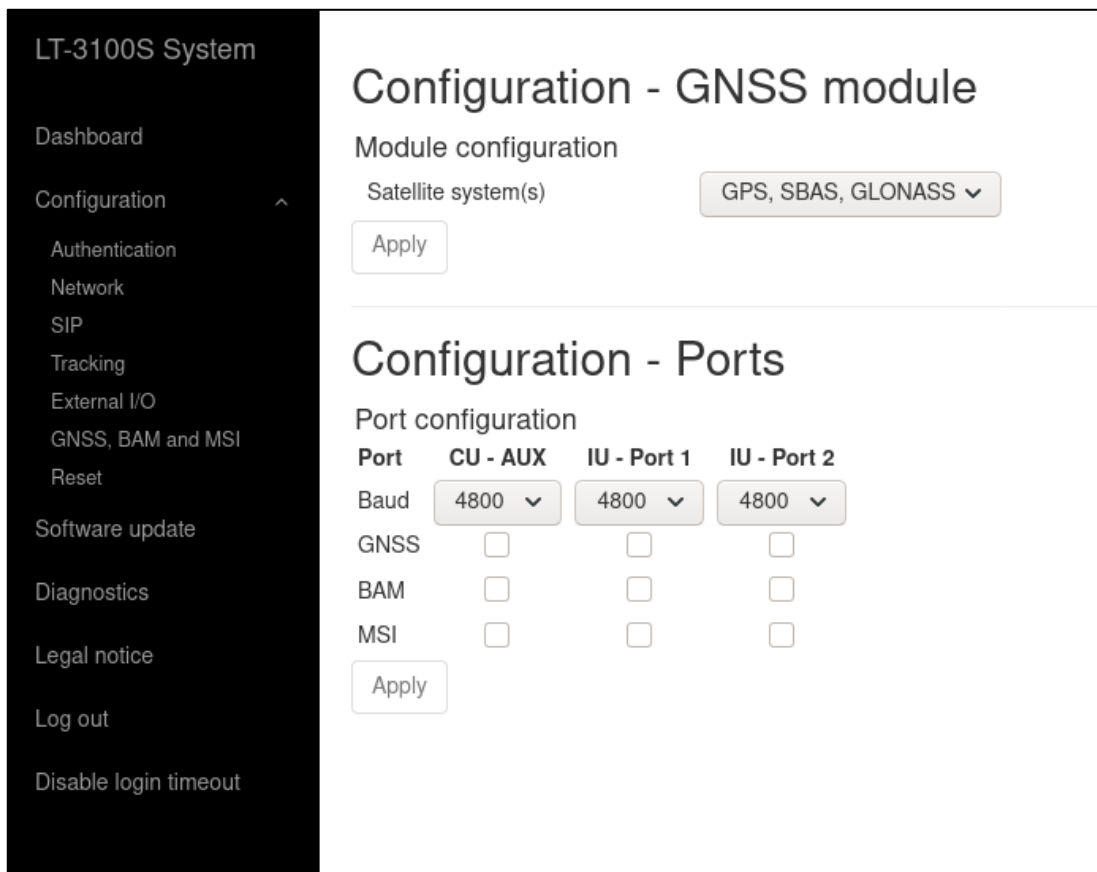

Figure 271: Web server (GNSS, BAM and MSI)

**NOTE:** The Port configuration illustrated above in Figure 271 for GNSS, BAM and MSI supports the following baud rates: 4800, 9600, and 38400. The baud rate can be configured individually per port. The ports are all bi-directional RS-422. Only BAM can receive data.

GNSS module

The GNSS receiver used in the LT-3130 Antenna Unit is a 72 ch. receiver with SBAS reception. The GNSS receiver performance is listed in Table 49.

GNSS receiver performance			
Data	Accuracy	Resolution	Comments
Position	GNSS: < 2.5 m SBAS: < 2 m	0.1 m	CEP, 50%, 24 hours static, -130 dBm, > 6 SVs By default, the GNSS receiver is configured for GPS, SBAS, GLONASS reception Time-To-First-Fix (cold acquisition): 26 s.
SOG	0.1 knot	0.1 knot	0 to 195 knots

Table 49: GNSS receiver performance

The GNSS receiver can be configured to the options listed in Table 50. The GPS, SBAS, GLONASS configuration is the recommended configuration.

GNSS Receiver configuration	
GNSS Receiver	Talker ID
GPS, SBAS, GLONASS	GN
GPS, SBAS, BeiDou	GN
GPS, SBAS	GP
GPS	GP
GLONASS	GL
BeiDou	GB

Table 50: GNSS receiver configuration

The horizontal position accuracy (static) has been measured for different configurations of the GNSS receiver, see Figure 272.

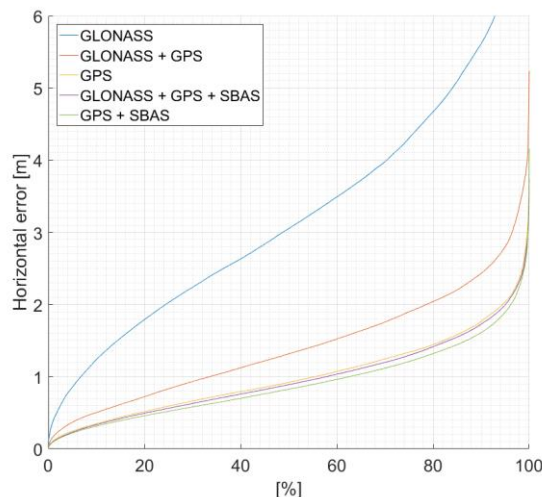

Figure 272: GNSS receiver horizontal position error

**IMPORTANT:** The installation of the LT-3130 Antenna Unit will affect the performance of the GNSS receiver. If line-of-sight to the GNSS satellites are disturbing the quality of the signal received by the GNSS receiver, then degraded performance must be accepted.

GNSS

The LT-3100S GMDSS system supports outputting of GNSS NMEA 0183 sentences via the LT-3110S Control Unit AUX (RS-422) or via the LT-3140S Interface Unit RS-422 (Port 1 or Port 2) interface. The AUX connector is described in detail in *Auxiliary (AUX)* on page 33. The GNSS output must be enabled via the web server, under Configuration - GNSS, BAM and MSI. The baud rate can be configured to 4.800, 9.600, or 38.400 baud. The output rate of the NMEA 0183 sentences is 1 Hz. Figure 273 below shows the NMEA 0183 sentences supported by the LT-3100S GMDSS system.

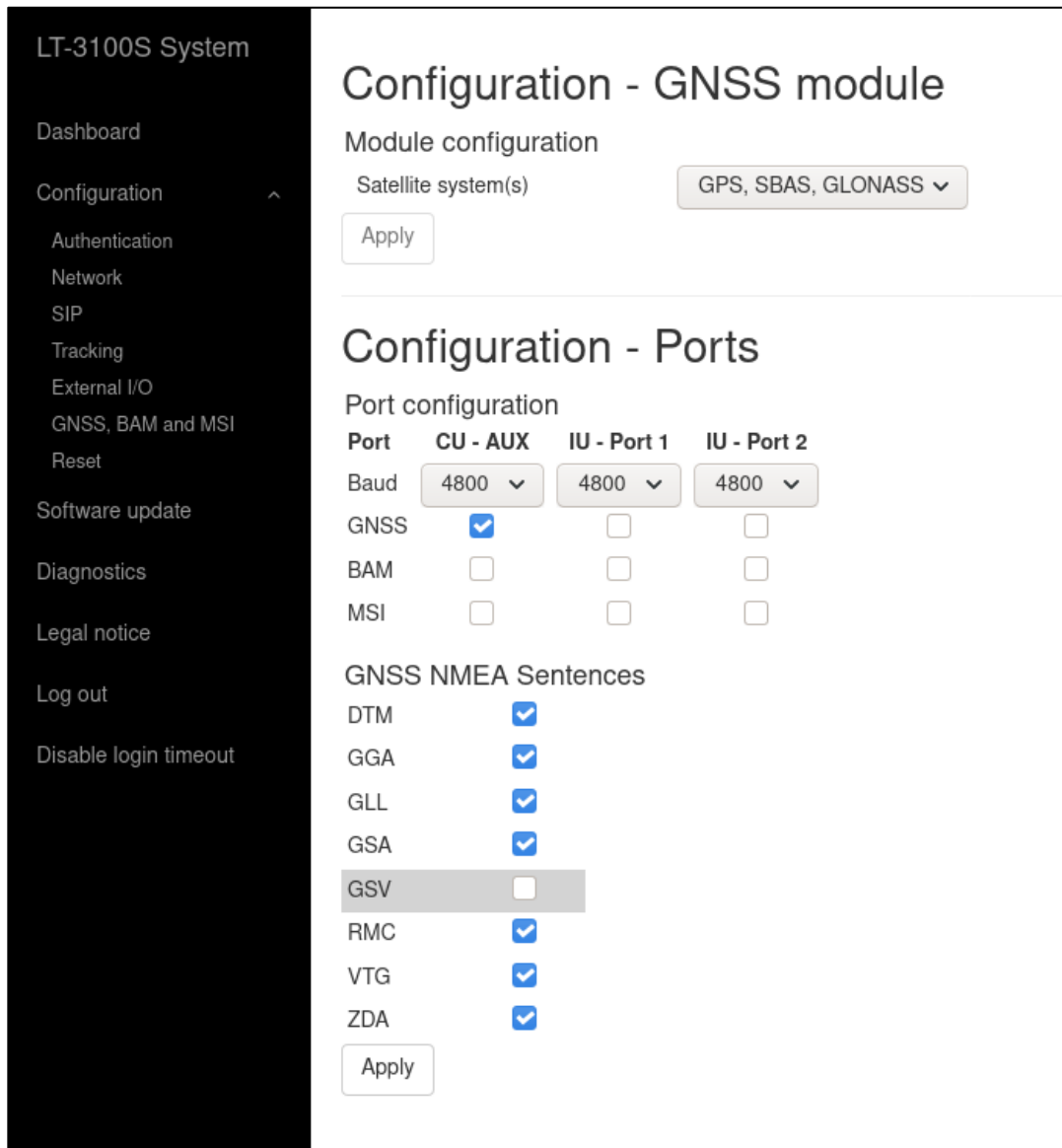

Figure 273: Web server (GNSS - NMEA 0183 sentences)

The GSV sentence is not supported for the 4.800 and 9.600 baud configuration.

**NOTE:** Changing the GNSS receiver configuration (default: GPS, SBAS, GLONASS) might affect the NMEA 0183 Talker ID. The Talker ID for the different configurations of the GNSS receiver is listed in Table 50 on page 172.

BAM and MSI

The LT-3100S GMDSS system supports BAM and MSI via the LT-3110S Control Unit AUX (RS-422) or via the LT-3140S Interface Unit RS-422 (Port 1 or Port 2) interface. The AUX connector is described in detail in *Auxiliary (AUX)* on page 33. BAM and MSI must be enabled via the web server, under Configuration - GNSS, BAM and MSI. The baud rate can be configured to 4.800, 9.600, or 38.400 baud. The BAM and MSI functions must be enabled individually on separate interfaces, see Figure 274 below.

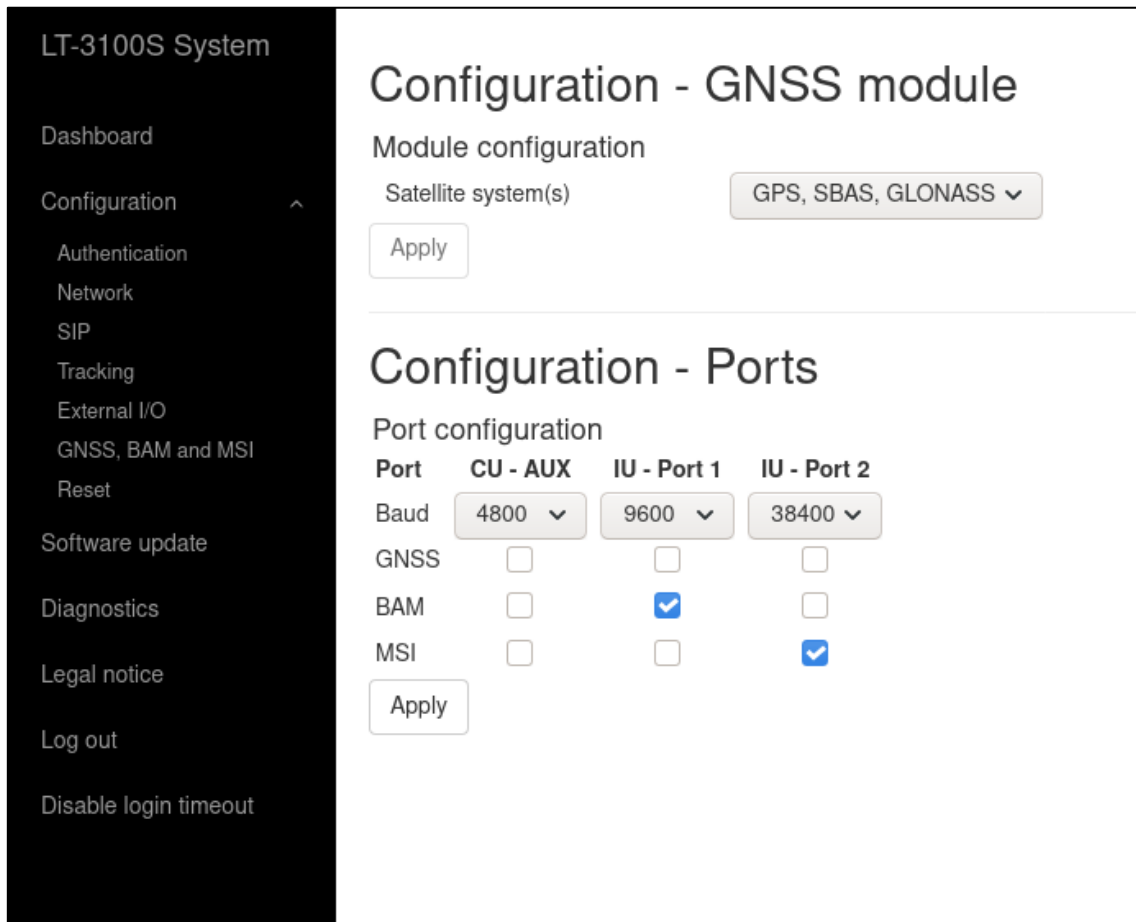

Figure 274: Web server (BAM and MSI)

**NOTE:** The LT-3110S Control Unit AUX connector is providing one bi-directional RS-422 interface. The LT-3140S Interface Unit RS-422 (Port 1 and 2) is providing two bi-directional RS-422 interfaces.

The Supported BAM sentences are described in *BAM sentences* on page 153. The Supported MSI sentences are described in *MSI sentences* on page 154.

### Reset to factory default

The LT-3100S GMDSS system support a reset to factory default. This reset functionality is only available via the web server, see Figure 275. By pressing 'Reset to factory default' and acknowledging this reset, the LT-3100S GMDSS system will configure all settings to default and remove all user data (e.g. Contact List, Call History, SMS, Safety Messages, Safety Calls, MSI, etc.). The LT-3100S GMDSS system will reboot once the factory reset has been affected and start up again showing the Installation Wizard in the display. The Installation Wizard must be completed again before the system is operational. The Installation Wizard is described and illustrated in *Installation Wizard* on page 57.

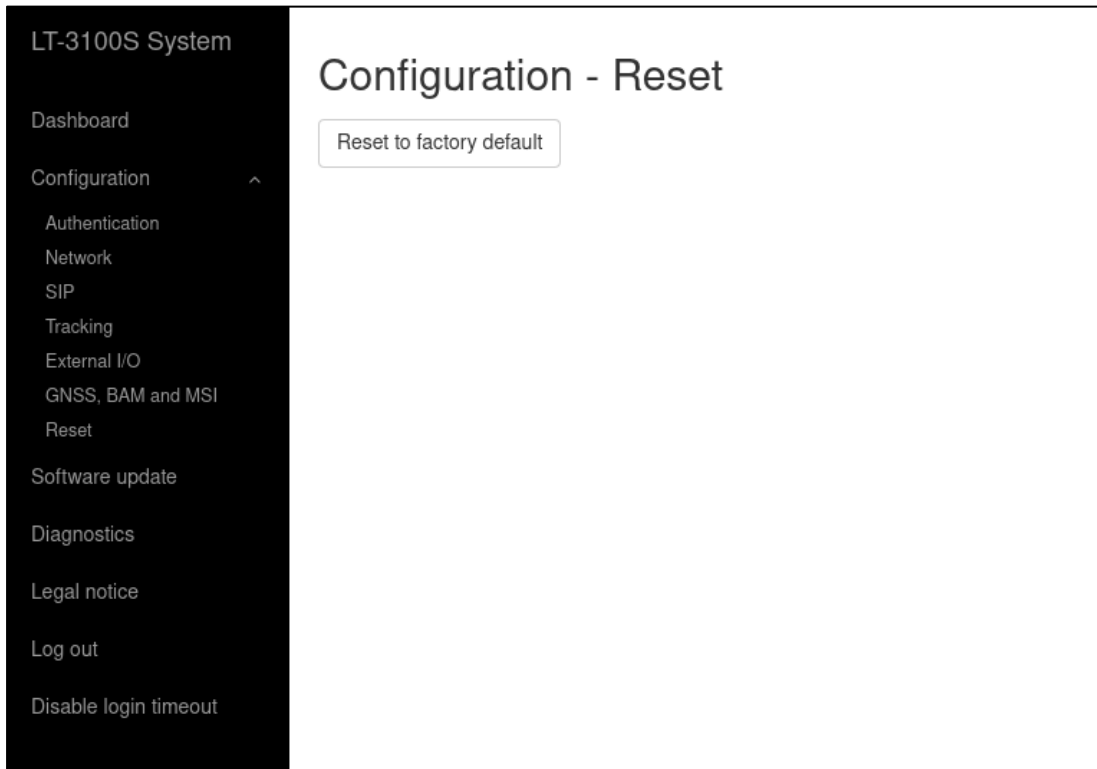

Figure 275: Web server (Reset to Factory Default)

**NOTE:** By 'Reset to factory default' the LT-3100S GMDSS system will lose all settings configured and user data will be lost. The system will be operational again once the Installation Wizard has been completed.

**NOTE:** A factory default reset will configure the following display and audio settings:  
Display: Mode = Day time and Brightness = 75%.  
Audio: Speaker Volume = 80%, handset Volume = 53%, Ringer Volume = 53%, and Key Beep = 40%.



## Software update

Carefully read the software release note, provided by Lars Thrane A/S, before software updating the LT-3100S GMDSS system.

Access the web server of the LT-3100S GMDSS system, by follow the instructions in *Accessing the built-in web server* on page 157. Select the 'Software update' web page and click the 'Choose File' button to select the LT-3100S GMDSS system file, which must be uploaded to the system. The software image has the following filename (example): LT-3100S-v1.02R-0040.Iti - the software image and release documentation will be available on the official company website: <https://www.thrane.eu>, under the specific product or in the Partner Area. Click the 'Upload' button to start the upload of the new software image. The upload and installation of the software image will take a few minutes. Progress indication bars can be monitored on the Software update webpage, while the software update is on-going. The LT-3100S GMDSS system will reboot once the software image is installed safely in all units. The LT-3100S GMDSS system will start up showing the Service Wizard, when the system has been software updated, see *Service Wizard* on page 69.

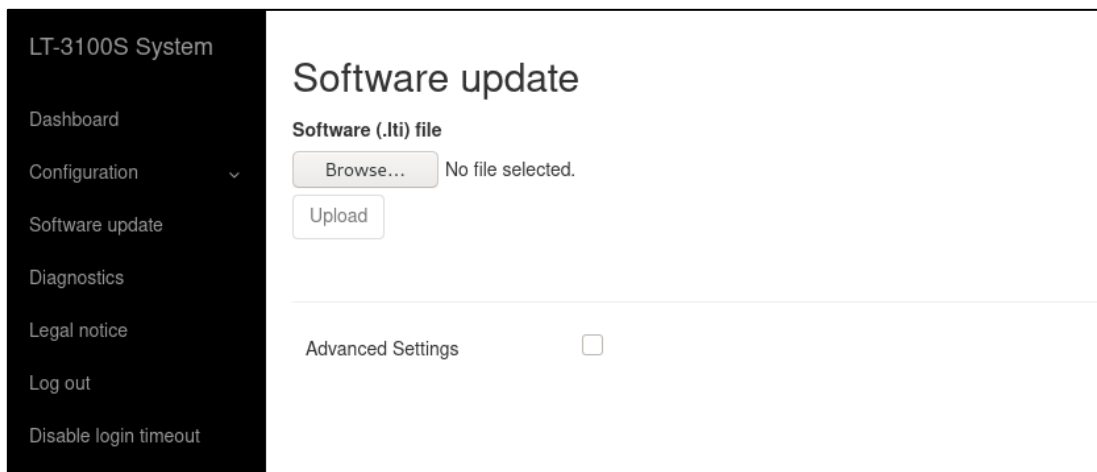

Figure 276: Web server (Software update)

**NOTE:** The LT-3110S Control Unit, LT-3130 Antenna Unit, LT-3140S Interface Unit, LT-3150S Alarm Panel, and LT-3160S Printer Adapter must be operated with the same software version. The software update will happen automatically, if the control unit identifies that the software version in the other units are different. Check or verify the web server Dashboard for software versions in each of the LT-3100S GMDSS system units, see *Dashboard* on page 158.

**IMPORTANT:** Do not remove power from the control unit or interface unit while the software update is on-going. Also, do not disconnect the antenna cable between the control unit and the antenna unit, while the software update is on-going.

**IMPORTANT:** The Advanced Settings shall not be used under normal circumstances. Do not use this function unless specifically instructed by Lars Thrane A/S or by GMDSS certified partner.

## Diagnostic

A diagnostic report can be downloaded from the webpage 'Diagnostics'. Navigate to the webpage and press the 'Download diagnostics report' button. A file with the following filename (example): LT-3100S\_00000061\_191115-152149.tar.gz will be downloaded to a location selected by the user. The Diagnostics Report can be sent back to Lars Thrane A/S in case of required support and assistance. The Diagnostics Report contains data describing the current state of the system and historical events. The data can be used by support to identify issues and determine their cause.

To help identifying a potential problem with the LT-3100S GMDSS system it is very important that the Diagnostic Report is sent back to Lars Thrane A/S.

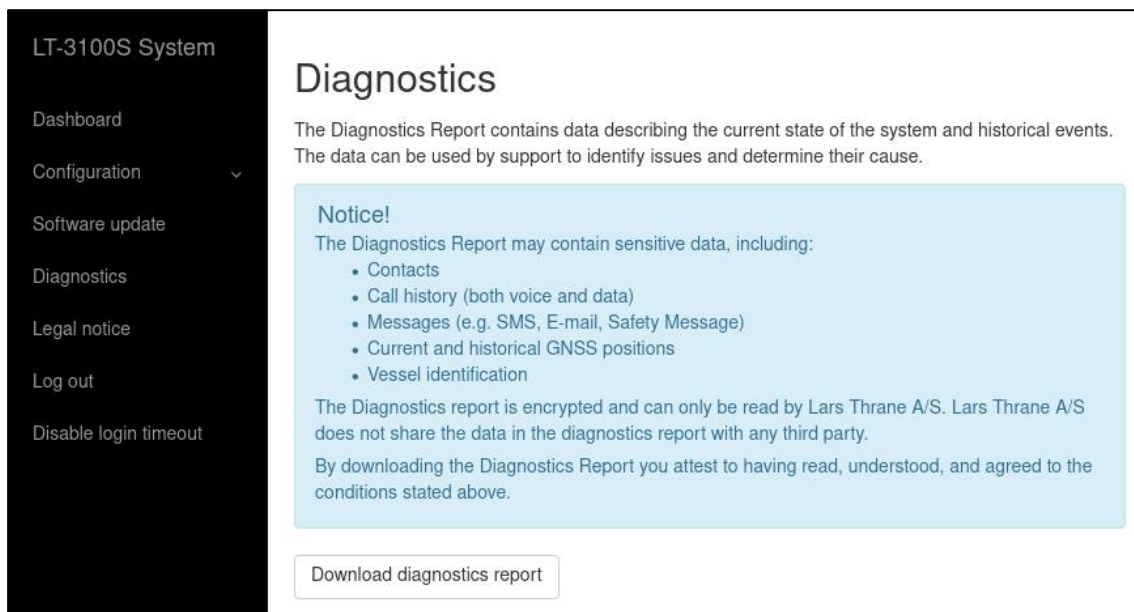

Figure 277: Web server (download diagnostics report)

**NOTE:** The diagnostic report is encrypted and can only be read by Lars Thrane A/S. Lars Thrane A/S does not share the data in the diagnostics report with any third party. By downloading and sending the diagnostic report to Lars Thrane A/S you attest to having read, understood, and agreed to the conditions stated under the Notice! (highlighted in Figure 277 above).

**Legal notice**

The LT-3100S GMDSS system contains Open Source software components. The Open Source software components used and related license information can be viewed by pressing the link ‘here’ under the Legal notice webpage, see Figure 278.

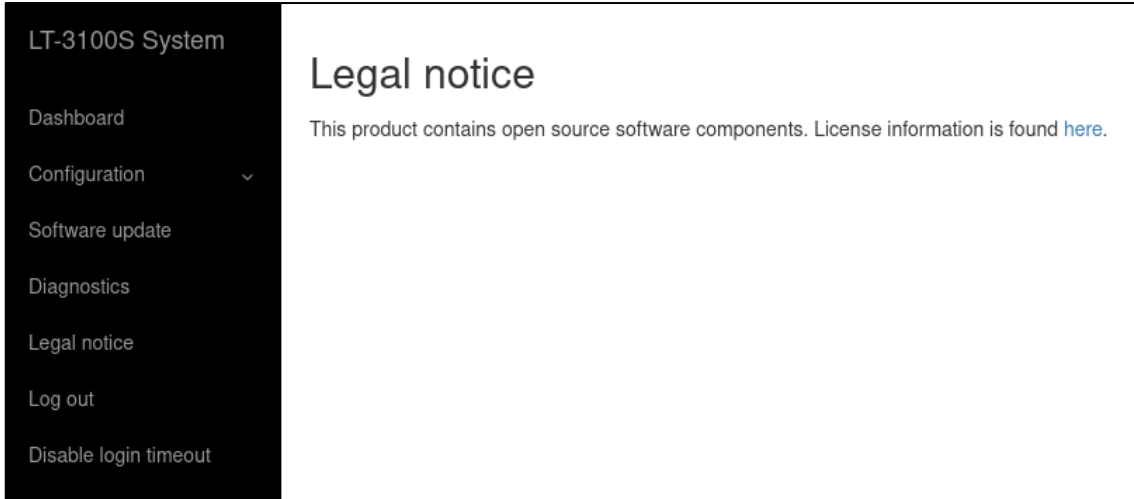

Figure 278: Web server (legal notice)

**Log out**

By pressing the ‘Log out’ webpage the web server will redirect you to the Authentication login, where it is required to use the Username and Password to re-enter the web server again. The Authentication is described in *Authentication* on page 160.

**Disable login timeout**

The web server will automatically logout after 5 minutes without activity. The user can disable this automatic logout by pressing the ‘Disable login timeout’ webpage, which then will change to a red color and text: ‘Enable login timeout’. The user must manually remove this configuration by pressing the webpage to go back to default settings and automatically logout.

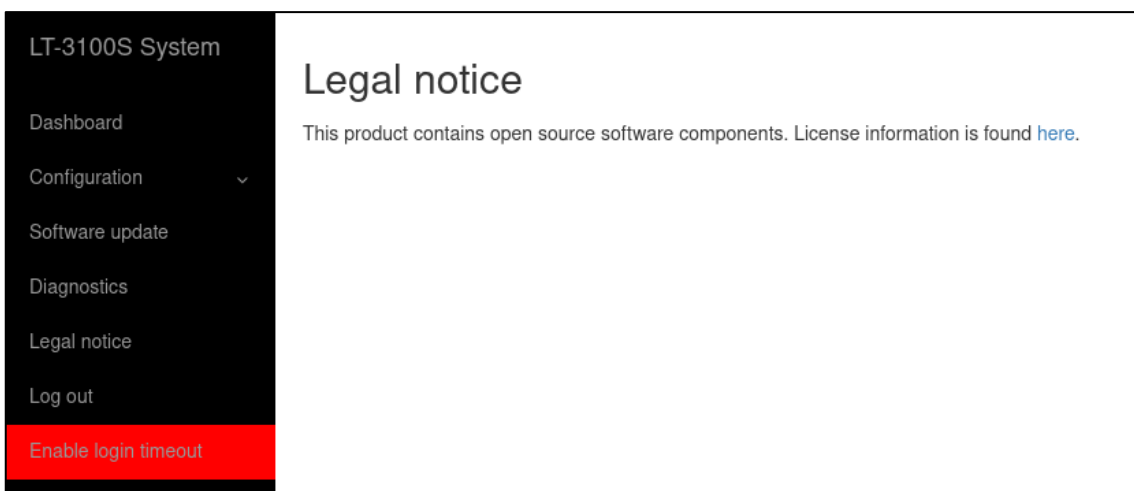

Figure 279: Web server (disable login timeout)

## Service & Repair

This section describes what the end-user must do in case of required service or repair.

**NOTE:** The LT-3100S GMDSS system does not require any scheduled maintenance or service. Make sure that the product is installed, as described in this manual, before making contact to the distributor or dealer for further assistance.

If the LT-3100S GMDSS system for some reason does not work as described in this manual, contact the distributor or dealer, from where the product was originally bought. The distributor or dealer will have experience and know-how to assist with further technical support and troubleshooting.

### Contact your GMDSS Partner:

- 1) Make sure to have the product name, unit part numbers, and unit serial numbers identified. The unit part numbers, and the unit serial numbers are identified on the unit label, which is found on the backside, or at the bottom side of the units. Alternatively, use the built-in web server to read-out the unit part numbers, and the unit serial numbers
- 2) Write a technical report about the observation or error. If possible, attach a picture of the installed product and include a wiring diagram. If possible, download a diagnostic report as described in *Diagnostic* on page 177
- 3) Send all information to the official LT GMDSS Partner

**IMPORTANT:** Unless otherwise agreed, the end-user shall always coordinate service and repair issues directly with the LT GMDSS Partner. This practice also applies for returning of products for service and repair.

All information that will get back to Lars Thrane A/S, either directly or indirectly, will be handled with confidentiality. End-user sensitive data will not be shared with any third party without prior written acceptance from the involved parties.

## Appendixes

### App. A - Applicable Standards

- [1] IEC 61097-16, Edition 1.0, 2019-07  
Global maritime distress and safety system (GMDSS)  
Part 16: Ship earth stations operating in mobile-satellite systems recognized for use in the GMDSS  
Operational and performance requirements, methods of testing and required test results
- [2] IEC 61162-1, Edition 5.0, 2016-08  
Maritime navigation and radiocommunication equipment and systems - Digital interfaces  
Part 1: Single talker and multiple listeners
- [3] IEC 61162-2, Edition 1.0, 1998-09  
Maritime navigation and radiocommunication equipment and systems - Digital interfaces  
Part 2: Single talker and multiple listeners, high-speed transmission
- [4] IEC 61162-450, Edition 2.0, 2018-05  
Maritime navigation and radiocommunication equipment and systems - Digital interfaces  
Part 450: Multiple talkers and multiple listeners – Ethernet interconnection
- [5] IEC 62923-1  
Maritime navigation and radiocommunication equipment and systems - Bridge alert management  
Part 1: Operational and performance requirements, methods of testing and required test results
- [6] IEC 62923-2  
Maritime navigation and radiocommunication equipment and systems - Bridge alert management  
Part 2: Alert and cluster identifiers and other additional features

**App. B - Bridge Alert Management (BAM)**

Alert generating functions

The LT-3100S GMDSS system contains the following functions capable of raising alerts.

Name	Can be deactivated	Description
GMDSS	No	Responsible for all GMDSS services (Distress Alert & Distress Call, Distress Alert Relay, MSI, Safety Voice, Safety Messaging). It is not possible to deactivate this function.
GNSS Position	Yes	The system can be configured to use either GNSS position (automatic) or manual position. Alerts of the disabled mode will be cleared.
Manual Position	Yes	
SIM	No	Responsible for managing the Subscriber Identity Module (SIM) card. It is not possible to deactivate this function.

*Table 51: Alert generating functions*

Alert categories

The BAM concept groups alerts into categories as a mean to indicate where an alert may be acknowledged (and thus also whether it can have its responsibility transferred):

Category	Description
A	Alert for which additional information at the alert source is necessary, as decision support for the evaluation of the alert related condition. Alert can only be acknowledged at the alert source.
B	Alert where no additional information for decision support is necessary besides the information which can be presented at the CAM UI. Alert may be acknowledged at the alert source and/or the CAM system.
C	Alert that cannot be acknowledged on the bridge but for which information is required about the status and treatment of the alert.

*Table 52: BAM alert categories*

List of alerts

<b>ID:</b>	3002	<b>Priority:</b>	Warning	<b>Category:</b>	B	<b>Resp. transfer:</b>	Yes
<b>Title:</b>	Lost handset			<b>Can ACK:</b>	Yes	<b>Transitory:</b>	No
<b>Description:</b>	Voice calls unavailable. Check handset cable						
<b>What to do:</b>	Check the cable between the handset and the Control Unit						
<b>Conditions:</b>	Raised when Control Unit loose connection with the Handset Rectified when connection is reestablished with the Handset.						
<b>Escalation:</b>	Repeated as a warning after 90 s.						

<b>ID:</b>	3002	<b>Priority:</b>	Warning	<b>Category:</b>	B	<b>Resp. transfer:</b>	Yes
<b>Title:</b>	Lost antenna			<b>Can ACK:</b>	Yes	<b>Transitory:</b>	No
<b>Description:</b>	GMDSS unavailable. Check antenna cable						
<b>What to do:</b>	Check the cable between the Control Unit and the Antenna Unit.						
<b>Conditions:</b>	Raised when Control Unit loose connection with the Antenna Unit Rectified when connection is reestablished with the Antenna Unit.						
<b>Escalation:</b>	Repeated as a warning after 90 s.						

<b>ID:</b>	3013	<b>Priority:</b>	Caution	<b>Category:</b>	B
<b>Title:</b>	Doubtful pos				
<b>Description:</b>	GMDSS update manual position				
<b>What to do:</b>	Update the manual position as described in <i>Position Settings</i> on page 108.				
<b>Conditions:</b>	<p>Raised in manual position mode if manually set position is older than 4 hours.  Rectified upon update of manual position.  Cleared to normal if position mode is set to automatic.</p>				

<b>ID:</b>	3016	<b>Priority:</b>	Caution	<b>Category:</b>	B
<b>Title:</b>	Lost position				
<b>Description:</b>	Check GMDSS terminal for lost position				
<b>What to do:</b>	Change to manual position mode as described in <i>Position Settings</i> on page 108.				
<b>Conditions:</b>	<p>Raised in automatic (GNSS) position mode if position is lost and stay lost for a minimum of 10 minutes.  Rectified if GNSS receiver obtains a valid position.  Cleared to normal if position mode is set to manual.</p>				

<b>ID:</b>	3062	<b>Priority:</b>	Warning	<b>Category:</b>	B	<b>Resp. transfer:</b>	Yes
<b>Title:</b>	System fault			<b>Can ACK:</b>	Yes	<b>Transitory:</b>	No
<b>Description:</b>	System self-check error. Try power-cycle system						
<b>What to do:</b>	Power-cycle the system. If that does not help, contact the service provider.						
<b>Conditions:</b>	Raised when the system self-check detects an unspecified internal error.						
<b>Escalation:</b>	Repeated as a warning after 90 s.						



<b>ID:</b>	3079	<b>Priority:</b>	Caution	<b>Category:</b>	B
<b>Title:</b>	Paper low				
<b>Description:</b>	Check GMDSS printer paper				
<b>What to do:</b>	Replace / refill printer paper.				
<b>Conditions:</b>	<p>Raised when printer is out of paper.          Rectified when printer has been filled with new paper.          Cleared to normal if printing to printer is disabled as described in <i>GMDSS Printer</i> on page 155.</p>				

<b>ID:</b>	3116	<b>Priority:</b>	Caution	<b>Category:</b>	B
<b>Title:</b>	Lost connection				
<b>Description:</b>	Check GMDSS satellite terminal				
<b>What to do:</b>	Verify the Antenna Unit has free line of sight to the sky. Remove any object blocking the line of sight if possible.				
<b>Conditions:</b>	<p>Raised when the terminal has been unable to detect or otherwise contact the satellites of the Iridium® satellite system for a period of one minute or more.          Rectified when the terminal detects the Iridium® satellite system.</p>				

<b>ID:</b>	3116	<b>Priority:</b>	Caution	<b>Category:</b>	B
<b>Title:</b>	Impaired radio				
<b>Description:</b>	MSI / Safety Message reception delayed				
<b>What to do:</b>	Verify the Antenna Unit has free line of sight to the sky. Remove any object blocking the line of sight if possible.				
<b>Conditions:</b>	<p>Raised when the terminal has been informed by the Iridium® network about new message(s) ready for download by the terminal but the terminal has failed to do so 3 times in a row.          Rectified when the terminal has successfully downloaded the message(s).</p>				

<b>ID:</b>	3116	<b>Priority:</b>	Caution	<b>Category:</b>	B
<b>Title:</b>	Impaired radio				
<b>Description:</b>	Reception of MSI delayed. MSI list is outdated				
<b>What to do:</b>	Verify the Antenna Unit has free line of sight to the sky. Remove any object blocking the line of sight if possible.				
<b>Conditions:</b>	<p>Raised when the terminal has been instructed by the Iridium® network to download MSI messages or Safety Messages pending for the terminal but have failed to do so 3 times in a row.</p> <p>Rectified when the terminal successfully downloads the messages.</p>				

<b>ID:</b>	3122	<b>Priority:</b>	Warning	<b>Category:</b>	A	<b>Resp. transfer:</b>	No
<b>Title:</b>	Distress Rx			<b>Can ACK:</b>	No	<b>Transitory:</b>	No
<b>Description:</b>	Incoming distress. Check GMDSS display						
<b>What to do:</b>	Read the received Distress Alert Relay (see <i>Maritime Safety Information (MSI)</i> on page 80).						
<b>Conditions:</b>	<p>Raised when a Distress Alert Relay message is received.</p> <p>Rectified when all Distress Alert Relay messages have been read.</p>						
<b>Escalation:</b>	Repeated as a warning after 90 s.						
<b>Other:</b>	In case of reception of multiple Distress Alert Relay messages, only one alert is raised.						

<b>ID:</b>	3122	<b>Priority:</b>	Warning	<b>Category:</b>	A	<b>Resp. transfer:</b>	No
<b>Title:</b>	Urgency Rx			<b>Can ACK:</b>	No	<b>Transitory:</b>	No
<b>Description:</b>	Incoming urgency warning. Check GMDSS display						
<b>What to do:</b>	Read the received urgency MSI message or urgency priority message (see <i>Maritime Safety Information (MSI)</i> on page 80 and <i>Safety Messaging</i> on page 89).						
<b>Conditions:</b>	<p>Raised when an urgency MSI message or urgency priority message is received.</p> <p>Rectified when all MSI messages and priority message of severity urgency have been read.</p>						
<b>Escalation:</b>	Repeated as a warning after 90 s.						
<b>Other:</b>	In case of reception of multiple urgency messages, only one alert is raised.						

<b>ID:</b>	3122	<b>Priority:</b>	Warning	<b>Category:</b>	A	<b>Resp. transfer:</b>	No
<b>Title:</b>	Distress missed			<b>Can ACK:</b>	No	<b>Transitory:</b>	No
<b>Description:</b>	Missed distress call. Check GMDSS display						
<b>What to do:</b>	Open the Call History to see the details on the missed call.						
<b>Conditions:</b>	Raised when an incoming distress priority voice call was not answered. Rectified when the Call History is accessed.						
<b>Escalation:</b>	Repeated as a warning after 90 s.						
<b>Other:</b>	In case of multiple missed calls, only one alert is raised.						

<b>ID:</b>	3122	<b>Priority:</b>	Warning	<b>Category:</b>	A	<b>Resp. transfer:</b>	No
<b>Title:</b>	Urgency missed			<b>Can ACK:</b>	No	<b>Transitory:</b>	No
<b>Description:</b>	Missed urgency call. Check GMDSS display						
<b>What to do:</b>	Open the Call History to see the details on the missed call.						
<b>Conditions:</b>	Raised when an incoming urgency priority voice call was not answered. Rectified when the Call History is accessed.						
<b>Escalation:</b>	Repeated as a warning after 90 s.						
<b>Other:</b>	In case of multiple missed calls, only one alert is raised.						

<b>ID:</b>	3123	<b>Priority:</b>	Caution	<b>Category:</b>	B		
<b>Title:</b>	MSI Rx						
<b>Description:</b>	Check new received maritime safety information						
<b>What to do:</b>	Read the received MSI message (see <i>Maritime Safety Information (MSI)</i> on page 80).						
<b>Conditions:</b>	Raised when a safety MSI message is received. Rectified when all MSI messages of severity safety have been read.						
<b>Other:</b>	In case of reception of multiple safety messages, only one alert is raised.						

<b>ID:</b>	3123	<b>Priority:</b>	Caution	<b>Category:</b>	B
<b>Title:</b>	Safety Rx				
<b>Description:</b>	Check new received safety message				
<b>What to do:</b>	Read the received priority message (see <i>Safety Messaging</i> on page 89).				
<b>Conditions:</b>	Raised when a safety priority message is received. Rectified when all priority messages of severity safety have been read.				
<b>Other:</b>	In case of reception of multiple safety messages, only one alert is raised.				

<b>ID:</b>	3123	<b>Priority:</b>	Caution	<b>Category:</b>	B
<b>Title:</b>	Safety missed				
<b>Description:</b>	Missed safety call. Check GMDSS display				
<b>What to do:</b>	Open the Call History to see the details on the missed call.				
<b>Conditions:</b>	Raised when an incoming safety priority voice call was not answered. Rectified when the Call History is accessed.				
<b>Other:</b>	In case of multiple missed calls, only one alert is raised.				

<b>ID:</b>	11402	<b>Priority:</b>	Warning	<b>Category:</b>	B	<b>Resp. transfer:</b>	Yes
<b>Title:</b>	Invalid antenna		<b>Can ACK:</b>	Yes	<b>Transitory:</b>	No	
<b>Description:</b>	GMDSS unavailable. Incompatible antenna						
<b>What to do:</b>	Replace the Antenna Unit with a compatible one (HW revision >= 2.00).						
<b>Conditions:</b>	Raised when the Control Unit detects an incompatible Antenna Unit revision.						
<b>Escalation:</b>	Repeated as a warning after 90 s.						
<b>Other:</b>	In case of multiple missed calls, only one alert is raised.						

<b>ID:</b>	15102	<b>Priority:</b>	Warning	<b>Category:</b>	B	<b>Resp. transfer:</b>	Yes
<b>Title:</b>	Lost SIM card			<b>Can ACK:</b>	Yes	<b>Transitory:</b>	No
<b>Description:</b>	GMDSS unavailable. Check SIM card						
<b>What to do:</b>	Verify the SIM card is properly inserted (see <i>GMDSS SIM card (SIM)</i> on page 31).						
<b>Conditions:</b>	Raised when the SIM card is removed or cannot be detected. Rectified when the SIM card is detected.						
<b>Escalation:</b>	Repeated as a warning after 90 s.						

<b>ID:</b>	21102	<b>Priority:</b>	Warning	<b>Category:</b>	B	<b>Resp. transfer:</b>	Yes
<b>Title:</b>	GMDSS fault			<b>Can ACK:</b>	Yes	<b>Transitory:</b>	No
<b>Description:</b>	GMDSS terminal rejected by Iridium network						
<b>What to do:</b>	Contact your service provider.						
<b>Conditions:</b>	Raised when the terminal is rejected by the Iridium® network.						
<b>Escalation:</b>	Repeated as a warning after 90 s.						

<b>ID:</b>	21102	<b>Priority:</b>	Warning	<b>Category:</b>	B	<b>Resp. transfer:</b>	Yes
<b>Title:</b>	GMDSS fault			<b>Can ACK:</b>	Yes	<b>Transitory:</b>	No
<b>Description:</b>	GMDSS antenna rejected by Iridium network						
<b>What to do:</b>	Contact your service provider.						
<b>Conditions:</b>	Raised when the Antenna Unit is rejected by the Iridium® network.						
<b>Escalation:</b>	Repeated as a warning after 90 s.						

<b>ID:</b>	21102	<b>Priority:</b>	Warning	<b>Category:</b>	B	<b>Resp. transfer:</b>	Yes
<b>Title:</b>	GMDSS fault			<b>Can ACK:</b>	Yes	<b>Transitory:</b>	No
<b>Description:</b>	GMDSS SIM card rejected by Iridium network						
<b>What to do:</b>	Contact your service provider.						
<b>Conditions:</b>	Raised when the SIM card is rejected by the Iridium® network.						
<b>Escalation:</b>	Repeated as a warning after 90 s.						

<b>ID:</b>	21202	<b>Priority:</b>	Warning	<b>Category:</b>	B	<b>Resp. transfer:</b>	Yes
<b>Title:</b>	Safety Tx fail			<b>Can ACK:</b>	Yes	<b>Transitory:</b>	Yes
<b>Description:</b>	Sending of ISM failed						
<b>What to do:</b>	Verify the Antenna Unit has free line of sight to the sky. Remove any object blocking the line of sight if possible. Then initiate resending of the message (see <i>Safety Messaging</i> on page 89).						
<b>Conditions:</b>	Raised when sending of a Safety Message permanently failed.						
<b>Escalation:</b>	Repeated as a warning after 90 s.						
<b>Other:</b>	In case transmission of multiple safety messages fails, only one alert is raised.						

## **App. C - Multiple talkers and multiple listeners**

IEC 61162 *Multiple talkers and multiple listeners* is a series of protocol definitions supporting both RS-422 and Ethernet for transporting its messages.

LT-3100S GMDSS system currently supports IEC 61162 over RS-422 only but is prepared for future support of IEC 61162 over Ethernet. Certification of compliance with IEC 61162-450 and IEC 61162-460 has been obtained and thus the LT-3100 GMDSS system is permitted to be connected to an IEC 61162 Ethernet network, though none of their functions are supported.

### ONF network node

The LT-3100S GMDSS system is classified as an ONF network node by IEC 61162 using the following protocols: DHCP, IPv4, IPv4LL, UDP, TCP, SIP, RTP, HTTP, HTTPS.

**App. D - GNSS sentences**

This appendix provides detailed information about the GNSS sentences supported by the LT-3100S GMDSS system. For further details see *GNSS sentences* on page 152 and web server configuration *GNSS, BAM and MSI* on page 171.

GNSS Talker identification mnemonics

The LT-3100S GMDSS system may use the following talker identifiers:

GNSS Talker Identification Mnemonics		
Talker Device	Identifier	Function
Global Navigation Satellite System (GNSS)	GN	GNSS
Global Positioning System (GPS)	GP	GNSS
GLONASS positioning system	GL	GNSS
BeiDou positioning system	GB	GNSS

*Table 53: GNSS Talker identification mnemonics*

GNSS Talker Sentence Overview

The table below lists all GNSS sentences the LT-3100S GMDSS system can transmit (as a talker):

GNSS Talker Sentences			
Sentence Formatter	Function	Description	Transmission Interval
DTM	GNSS	Datum reference	1 s
GGA	GNSS	Global positioning system (GPS) fix data	1 s
GLL	GNSS	Geographic position – latitude / longitude	1 s
GSA	GNSS	GNSS DOP and active satellites	1 s
GSV	GNSS	GNSS satellites in view	1 s
RMC	GNSS	Recommended minimum specific GNSS data	1 s
VTG	GNSS	Course over ground and ground speed	1 s
ZDA	GNSS	Time and date	1 s

*Table 54: GNSS Talker Sentences*

GNSS Listener sentences overview

No listener sentences available for GNSS.



GNSS Talker sentences

```
$--DTM,ccc,a,x.x,a,x.x,a,x.x,ccc*hh<CR><LF>
```

```
$--GGA,hhmmss.ss,1111.11,a,yyyy.yy,a,x,xx,x.x,x.x,M,x.x,M,x.x,xxxx*hh<CR><LF>
```

**NOTE:** The "Age of differential GPS data" field (no. 13) is always null.

```
$--GLL,1111.11,a,yyyy.yy,a,hhmmss.ss,A,a*hh<CR><LF>
```

```
$--GSA,a,x,xx,xx,xx,xx,xx,xx,xx,xx,xx,xx,xx,xx,x.x,x.x,x.x,h*hh<CR><LF>
```

```
$--GSV,x,x,xx,xx,xx,xxx,xx.....,xx,xx,xxx,xx,h*hh<CR><LF>
```

```
$--RMC,hhmmss.ss,A,1111.11,a,yyyy.yy,a,x.x,x.x,xxxxxx,x.x,a,a,a*hh<CR><LF>
```

**NOTE:** The "Magnetic variation" fields (no. 10 and 11) are always null.

```
$--VTG,x.x,T,x.x,M,x.x,N,x.x,K,a*hh<CR><LF>
```

**NOTE:** The "Course over ground, degrees magnetic" field (no. 3) is always null.

```
$--ZDA,hhmmss.ss,xx,xx,xxxx,xx,xx*hh<CR><LF>
```

GNSS Listener sentences

No listener sentences available for GNSS.

**App. E - BAM sentences**

This appendix provides detailed information about the BAM sentences supported by the LT-3100S GMDSS system. For further details see *BAM sentences* on page 153 and web server configuration *GNSS, BAM and MSI* on page 171.

BAM Talker identification mnemonics

The LT-3100S GMDSS system may use the following talker identifiers:

BAM Talker Identification Mnemonics		
Talker Device	Identifier	Function
Communications - satellite	CS	BAM

*Table 55: BAM talker identification mnemonics*

BAM Talker Sentence Overview

The table below lists all BAM sentences the LT-3100S GMDSS system can transmit (as a talker):

BAM Talker Sentences			
Sentence Formatter	Function	Description	Transmission Interval
ALC	BAM	Cyclic alert list	30 s
ALF	BAM	Alert sentence	n/a
ARC	BAM	Alert command refused	n/a

*Table 56: BAM talker sentences*

BAM Listener sentences overview

The table below lists all sentences the LT-3100S GMDSS system can receive (as a listener):

BAM Listener Sentences			
Sentence Formatter	Function	Description	Presence
ACN	BAM	Alert command	Optional
HBT	BAM	Heartbeat supervision sentences	Optional

*Table 57: BAM listener sentences*

BAM talker sentences

```
$--ALC,xx,xx,xx,x.x,aaa,x.x,x.x,x.x,.....,aaa,x.x,x.x,x.x*hh<CR><LF>
```

```
$--ALF,x,x,x,hhmmss.ss,a,a,a,aaa,x.x,x.x,x.x,x,c---c*hh<CR><LF>
```

**NOTE:** If the UTC time was not known when the alert changed state, the “Time of last change” field (no. 4) is null.

```
$--ARC,hhmmss.ss,aaa,x.x,x.x,c*hh<CR><LF>
```

**NOTE:** If the UTC time was not known when the alert changed state, the “Time” field (no. 1) is null.

BAM listener sentences

```
$--ACN,hhmmss.ss,aaa,x.x,x.x,c,a*hh<CR><LF>
```

**NOTE:** The “Time” field (no. 1) is ignored and optional.

```
$--HBT,x.x,A,x*hh<CR><LF>
```

**APP. F - MSI sentences**

This appendix provides detailed information about the MSI sentences supported by the LT-3100S GMDSS system. For further details see *MSI sentences* on page 154 and web server configuration *GNSS, BAM and MSI* on page 171.

MSI talker identification mnemonics

The LT-3100S GMDSS system may use the following talker identifiers:

MSI Talker Identification Mnemonics		
Talker Device	Identifier	Function
Communications - satellite	CS	MSI

*Table 58: MSI talker identification mnemonics*

MSI talker sentence overview

The table below lists all MSI sentences the LT-3100S GMDSS system can transmit (as a talker):

MSI Sentences			
Sentence Formatter	Function	Description	Transmission Interval
SM1	MSI	SafetyNET message, all ships / NAVAREA	n/a
SM2	MSI	SafetyNET message, coastal warning area	n/a
SM3	MSI	SafetyNET message, circular area address	n/a
SM4	MSI	SafetyNET message, rectangular area address	n/a
SMB	MSI	SafetyNET message body	n/a
SMV	MSI	SafetyNET message, vessel in distress information	n/a

*Table 59: MSI sentences*

MSI listener sentences overview

No listener sentences available for MSI.

MSI talker sentences

```
$--SM1,A,x.x,xxxxxxx,xxx,x,x,xx,xx,xxxx,xx,xx,xx,xx,xx*hh
```

```
$--SM2,A,x.x,xxxxxxx,xxx,x,x,xx,xx,xxxx,xx,xx,xx,xx,xx,a,a*hh
```

```
$--SM3,A,x.x,xxxxxxx,xxx,x,x,xx,xx,xxxx,xx,xx,xx,xx,1111.11,a,yyyyy.yy,a,xxx*hh
```

```
$--SM4,A,x.x,xxxxxxx,xxx,x,x,xx,xx,xxxx,xx,xx,xx,xx,1111.11,a,yyyyy.yy,a,xx,xxx*hh
```

```
$--SMB,xxx,xxx,x,x.x,c--c*hh
```

```
$--SMV,x,x,x,x.x,xxxxxxxxxx,c--c,1111.11,a,yyyyy.yy,a,xxxx,xx,xx,xx,xx,a*hh
```

MSI listener sentences

No listener sentences available for MSI.

**App. G - GNSS Receiver Integrity States (Automatic GNSS)**

The LT-3100S GMDSS system has a built-in GNSS receiver located in the LT-3130 Antenna Unit. The GNSS receiver is used under normal conditions for providing the LT-3100S GMDSS system with time, data, and position information to all required functions in the system. The LT-3100S GMDSS system can be configured to the positions settings modes: 1) Automatic GNSS (default) or 2) Manual Input. Position Settings is located in the GMDSS submenu (MENU -> GMDSS -> Position Settings) described and illustrated in *Position Settings* on page 108. Position Status is located in the System submenu (MENU -> System) described and illustrated in *System* starting on page 143.

Table 60 illustrates the GNSS receiver integrity states in Automatic GNSS position mode. The color marking has the following meaning:

- Colored Yellow -> low integrity
- Colored Orange-> Invalid

GNSS Receiver Integrity States (Automatic GNSS)							
State	UTC	POSN	POSN (age)	Horizontal Accuracy	COG [°]	SOG [kts]	Comments
System has just booted and there is not yet a fix	Acquiring...	Acquiring...	-	-	-	-	System booting up
System has just booted and only time is known	Time	Acquiring...	-	-	-	-	System booting up
Horizontal accuracy > 50 m (SOG = 0 kts)	Time	Lat/Long	Up to date	> 50 m	XXX.X	XX.X	System booting up
Horizontal accuracy < 50 m (SOG = 0 kts)	Time	Lat/Long	Up to date	< 50 m	XXX.X	XX.X	Normal GNSS receiver state.
SOG > 1 m/s (~ 2 kts)	Time	Lat/Long	Up to date	< 50 m	XXX.X	XX.X	Normal GNSS receiver state.
GNSS fix completely lost (last known position has age > 0 min)	Time (old)	Lat/Long	> 0 min	-	-	-	No fix on GNSS receiver (time and position).
GNSS fix completely lost (last known position has age 23 hours 59 min)	Time (old)	Lat/Long	≤ 23 hours 59 min	-	-	-	No fix on GNSS receiver (time and position).
GNSS fix completely lost (last known position has age ≥ 24 hours)	Time (old)	Lat/Long Acquiring...	≥ 24 hours	-	-	-	No fix on GNSS receiver (time and position).

Table 60: GNSS Receiver Integrity States (Automatic GNSS)

Table 60 is illustrating the GNSS receiver integrity states in Automatic GNSS position mode. The following pages will illustrate all relevant states.

System has just booted and there is not yet a fix

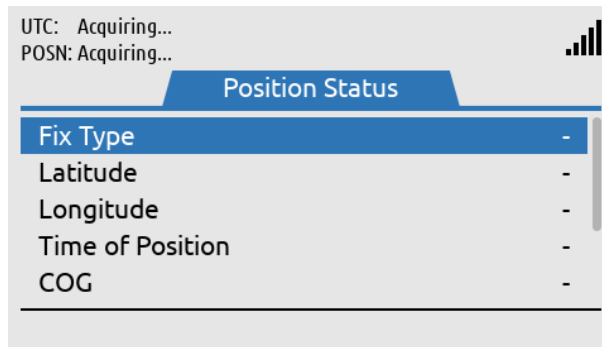

Figure 280: GNSS Receiver Integrity State

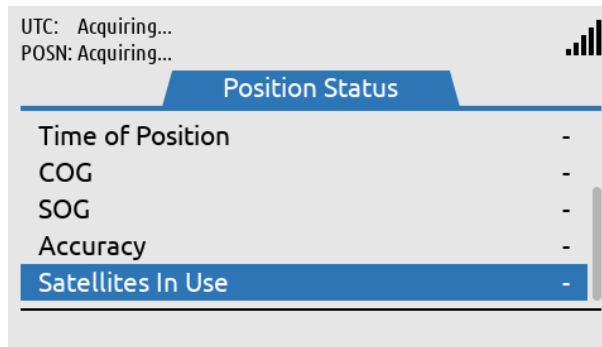

Figure 281: GNSS Receiver Integrity State

System has just booted and only time is known

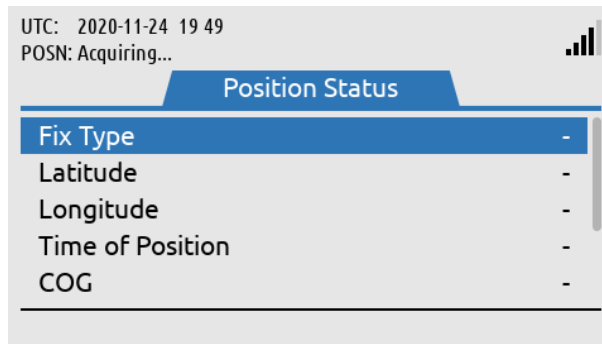

Figure 282: GNSS Receiver Integrity State

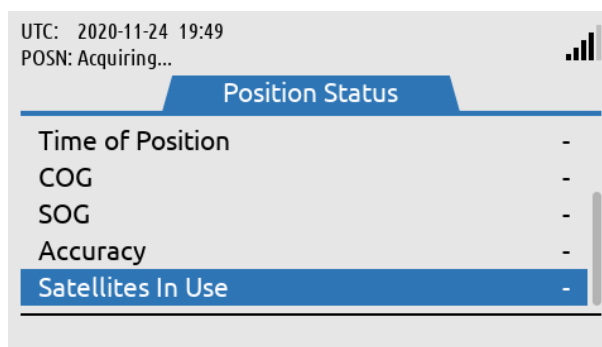

Figure 283: GNSS Receiver Integrity State

Horizontal accuracy > 50 m (SOG = 0 kts)

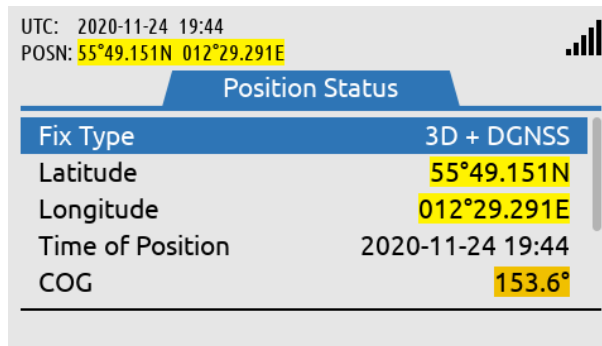

Figure 284: GNSS Receiver Integrity State

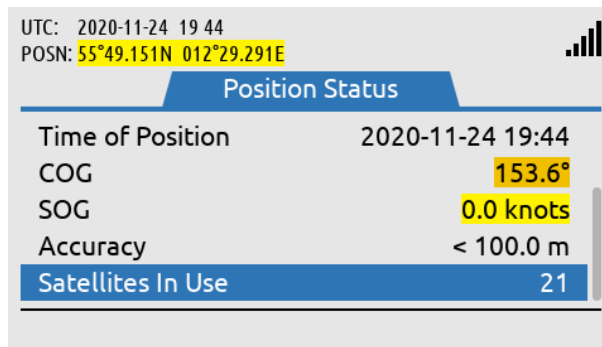

Figure 285: GNSS Receiver Integrity State

Horizontal accuracy < 50 m (SOG = 0 kts)

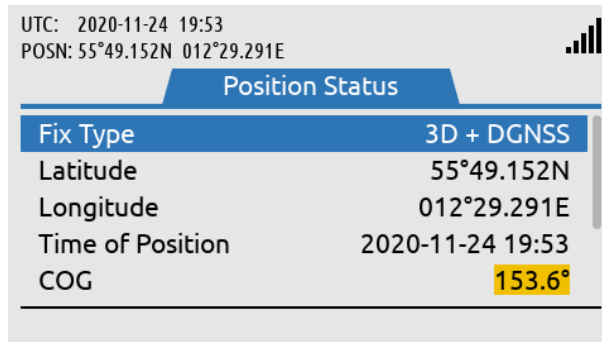

Figure 286: GNSS Receiver Integrity State

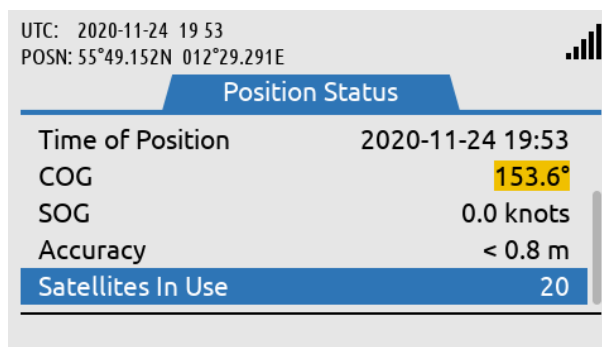

Figure 287: GNSS Receiver Integrity State



SOG > 1 m/s (~ 2 kts)

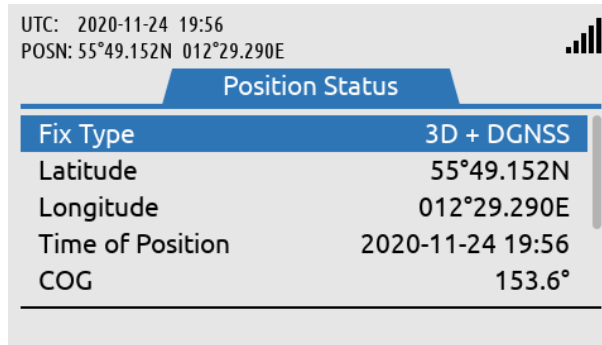

Figure 288: GNSS Receiver Integrity State

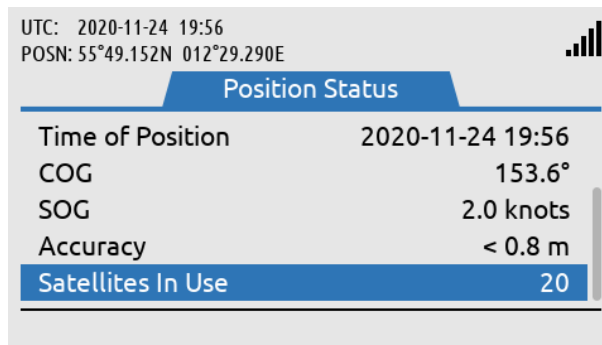

Figure 289: GNSS Receiver Integrity State

GNSS fix completely lost (last known position has age 10 min)

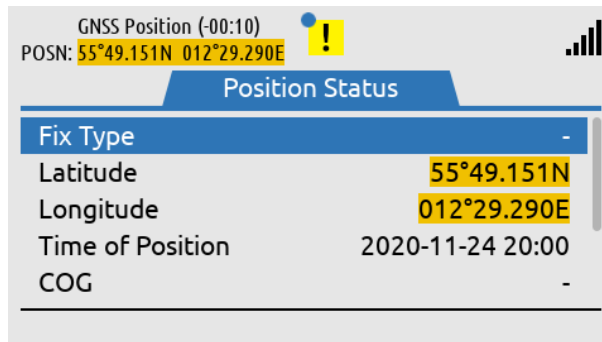

Figure 290: GNSS Receiver Integrity State

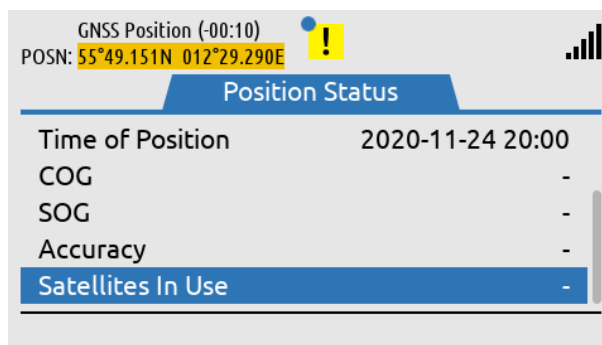

Figure 291: GNSS Receiver Integrity State

GNSS fix completely lost (last known position has age 23 hours 59 min)

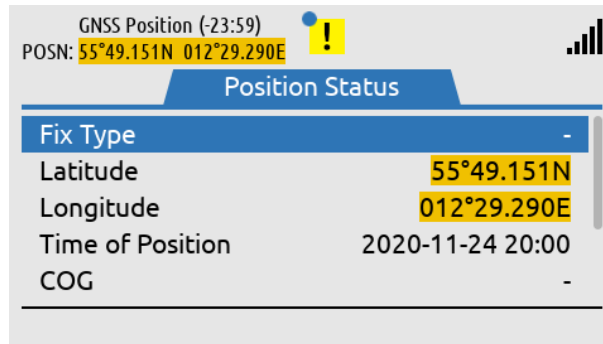

Figure 292: GNSS Receiver Integrity State

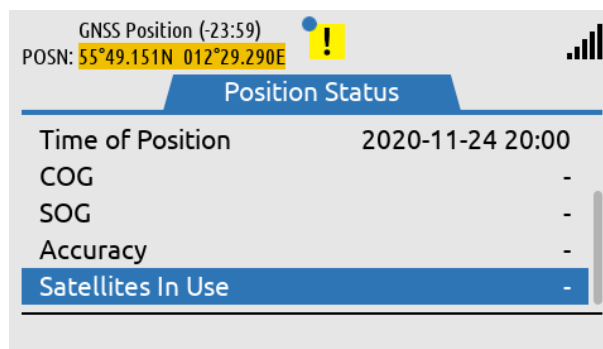

Figure 293: GNSS Receiver Integrity State

GNSS fix completely lost (last known position has age >= 24 hours)

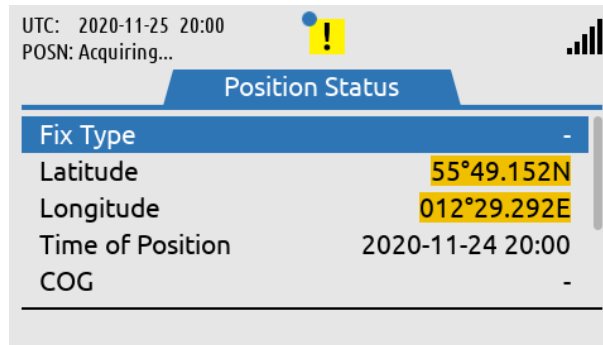

Figure 294: GNSS Receiver Integrity State

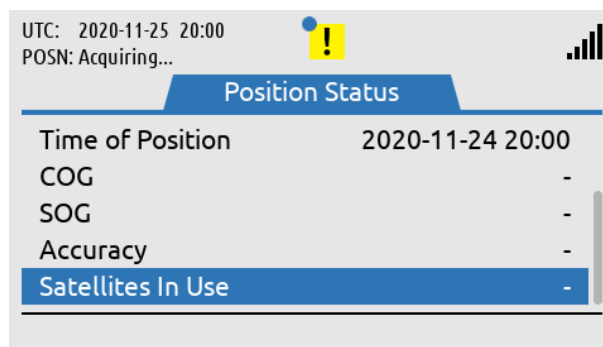

Figure 295: GNSS Receiver Integrity State

**App. H - Specifications*****LT-3100S GMDSS Satellite Communications System***

Certification & standards	Wheelmark Modul B and Module D, RED, FCC, ISED, RoHS 2, Iridium®
Vibration, operational	IEC 60945
Vibration, shock	Half sine 20 g/11 ms
Compass Safe Distance, std.	1.0 m (3.3 ft)
Compass Safe Distance, steer.	0.9 m (3.0 ft)
BAM EUT function types	P

***LT-3110S Control Unit***

Power consumption: operating mode, max	40.8 W
Weight	0.67 kg (1.48 lbs)
Dimensions	224.0 x 120.0 x 70.0 mm (8.82 x 4.72 x 2.76 in)
Temperature, operational	-15°C to +55°C (+5°F to +131°F)
IP rating, dust and water	IP32
Interfaces	Ethernet, auxiliary, DC input, chassis ground Antenna Unit (N conn.), handset, Bluetooth, SIM card
Input power	12-24 VDC (2.2-1.7 A)
BT transmitter, Max RF output power	10 mW
BT transmitter, Frequency bands	TX: 2402-2480MHz, RX:2402-2480MHz

***LT-3120 Handset***

Weight	0.30 kg (0.66 lbs)
Dimensions	52.8 x 208.8 x 38.2 mm (2.08 x 8.22 x 1.50 in)
Temperature, operational	-15°C to +55°C (+5°F to +131°F)
IP rating, dust and water	IP32

***LT-3121 Cradle***

Weight	0.07 kg (0.15 lbs)
Dimensions	106.9 x 57.4 x 29.3 mm (4.21 x 2.26 x 1.15 in)

***LT-3130 Antenna Unit***

Weight (without mount)	0.72 kg (1.59 lbs)
Dimensions	151.1 x Ø 149.5 mm (5.95 x Ø 5.89 in)
Temperature, operational (12 VDC input power)	-30°C to +55°C (-22°F to +131°F)
Temperature, operational (24 VDC input power)	-40°C to +55°C (-40°F to +131°F)
IP rating, dust and water	IP67
Interfaces	Control Unit (N conn.)
Iridium transmitter, Max RF output power	8 W
Iridium transmitter, Frequency bands	TX: 1616-1626,50MHz, RX: 1616-1626,50MHz
Antenna communication cable	Coaxial cable, up to 500 m (1500 ft)

**App. H - Specifications (continued)*****LT-3140S Interface Unit***

Power consumption: operating mode, max	10.0 W
Weight	0.71 kg (1.57 lbs)
Dimensions	227.0 x 186.0 x 40.0 mm (8.94 x 7.32 x 1.57 in)
Temperature, operational	-15°C to +55°C (+5°F to +131°F)
IP rating, dust and water	IP20
Interfaces	4 x Ethernet, 2 x RS-422, 4 x GPIO, 4 x CAN DC input, chassis ground
Input power	12-24 VDC (0.7-0.4 A)

***LT-3150S Alarm Panel***

Weight / Weight (incl. 25m cable)	0.07 kg (0.15 lbs) / 1.29 (2.84 lbs)
Dimensions	52.0 x 82.0 x 26.0 mm (2.05 x 3.23 x 1.02 in)
Temperature, operational	-15°C to +55°C (+5°F to +131°F)
IP rating, dust and water	IP30
Interfaces	1 x CAN

***LT-3160S Printer Adapter***

Weight / Weight (incl. 25m cable)	0.03 kg (0.07 lbs) / 1.25 kg (2.76 lbs)
Dimensions	62.1 x 68.1 x 19.4 mm (2.44 x 2.68 x 0.76 in)
Temperature, operational	-15°C to +55°C (+5°F to +131°F)
IP rating, dust and water	IP40
Interfaces	1 x CAN

Warranty	2 year
Maintenance	None

App. I - Outline Drawing: LT-3110S Control Unit

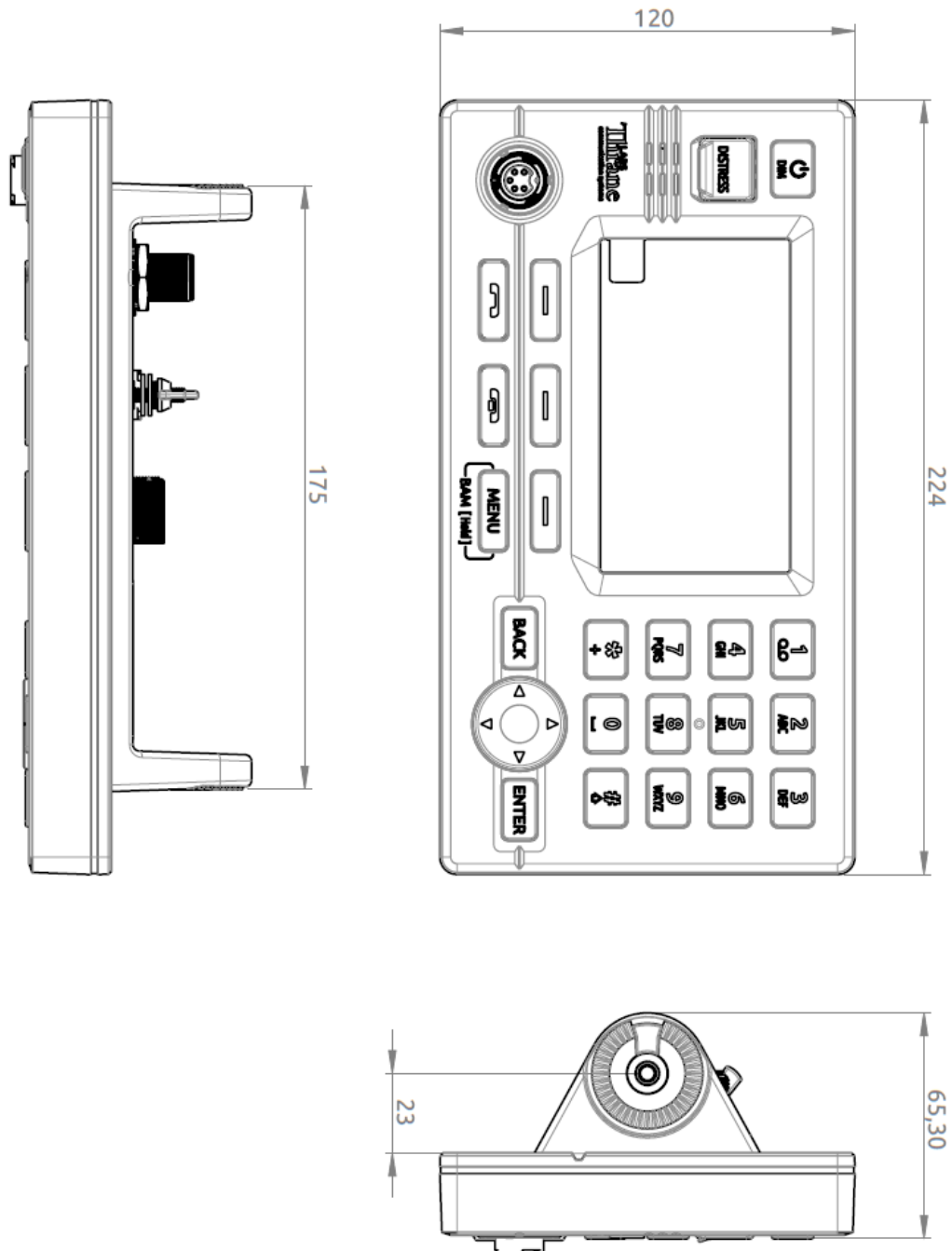
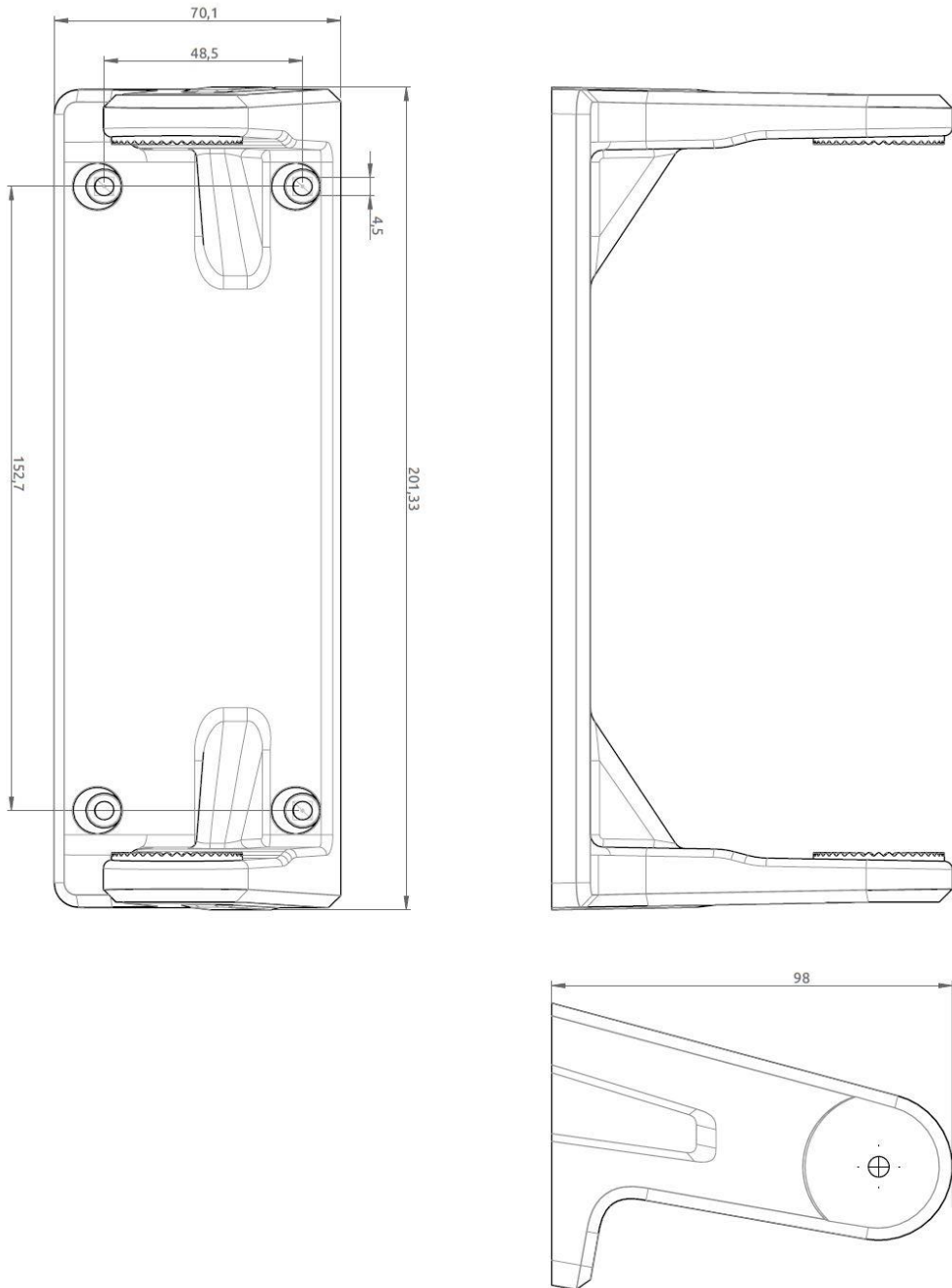

Figure 296: Outline Drawing: LT-3110S Control Unit

**App. J - Outline Drawing: Bracket Mount, Control Unit**



*Figure 297: Outline Drawing: Bracket Mount, Control Unit*

App. K - Outline Drawing: Flush Mount, Control Unit

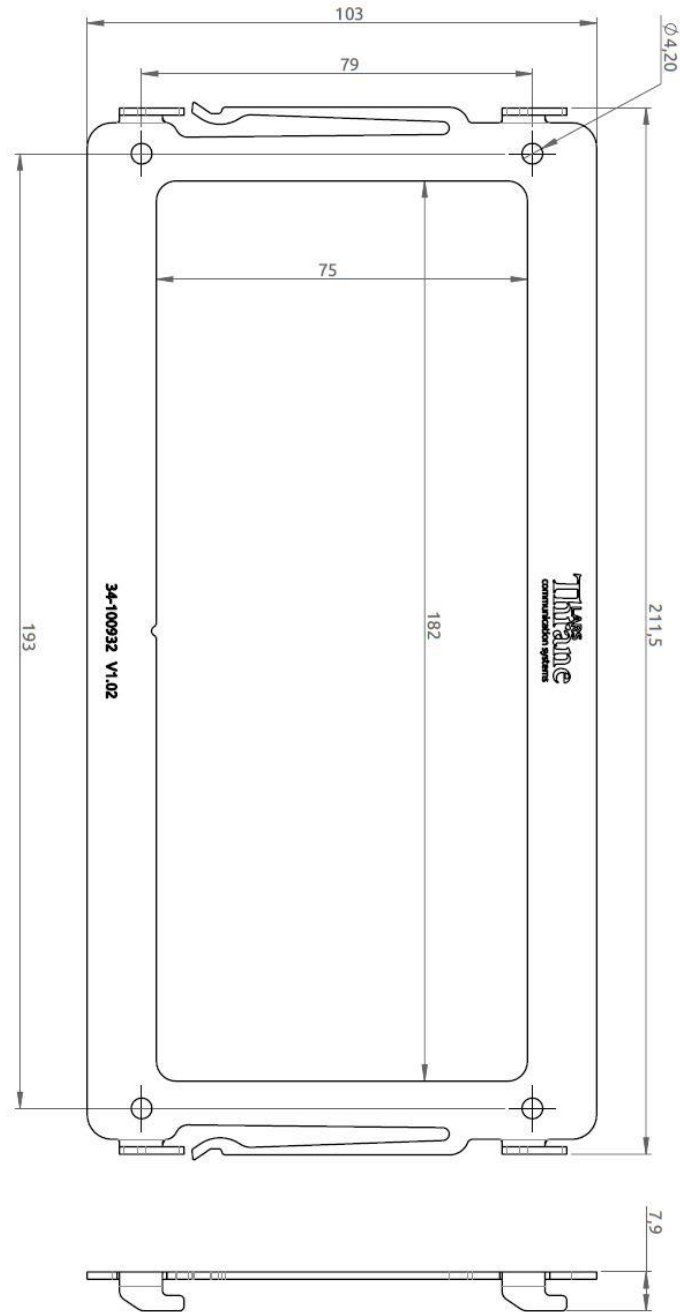

Figure 298: Outline Drawing: Flush Mount, Control Unit

App. L - Outline Drawing: LT-3130 Antenna Unit

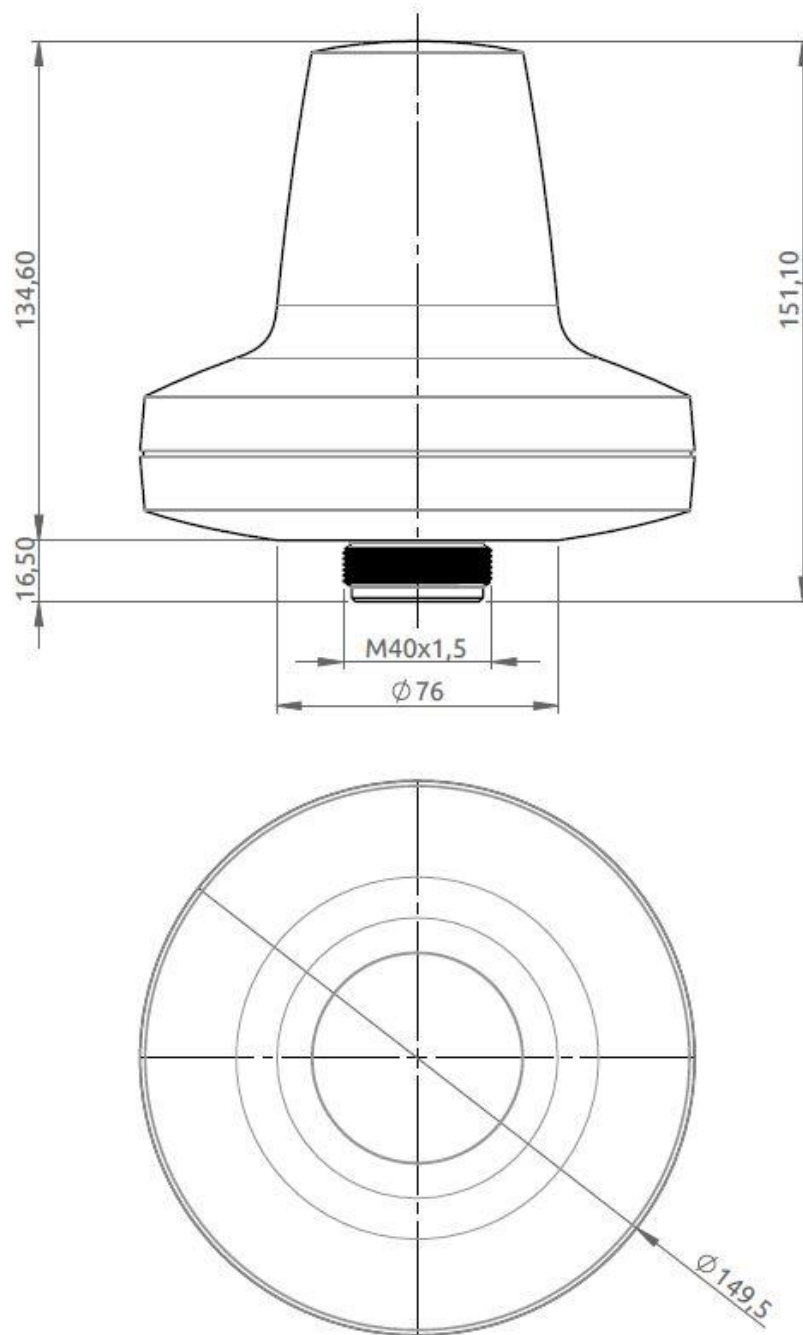

Figure 299: Outline Drawing: LT-3130 Antenna Unit



App. M - Outline Drawing: LT-3140S Interface Unit

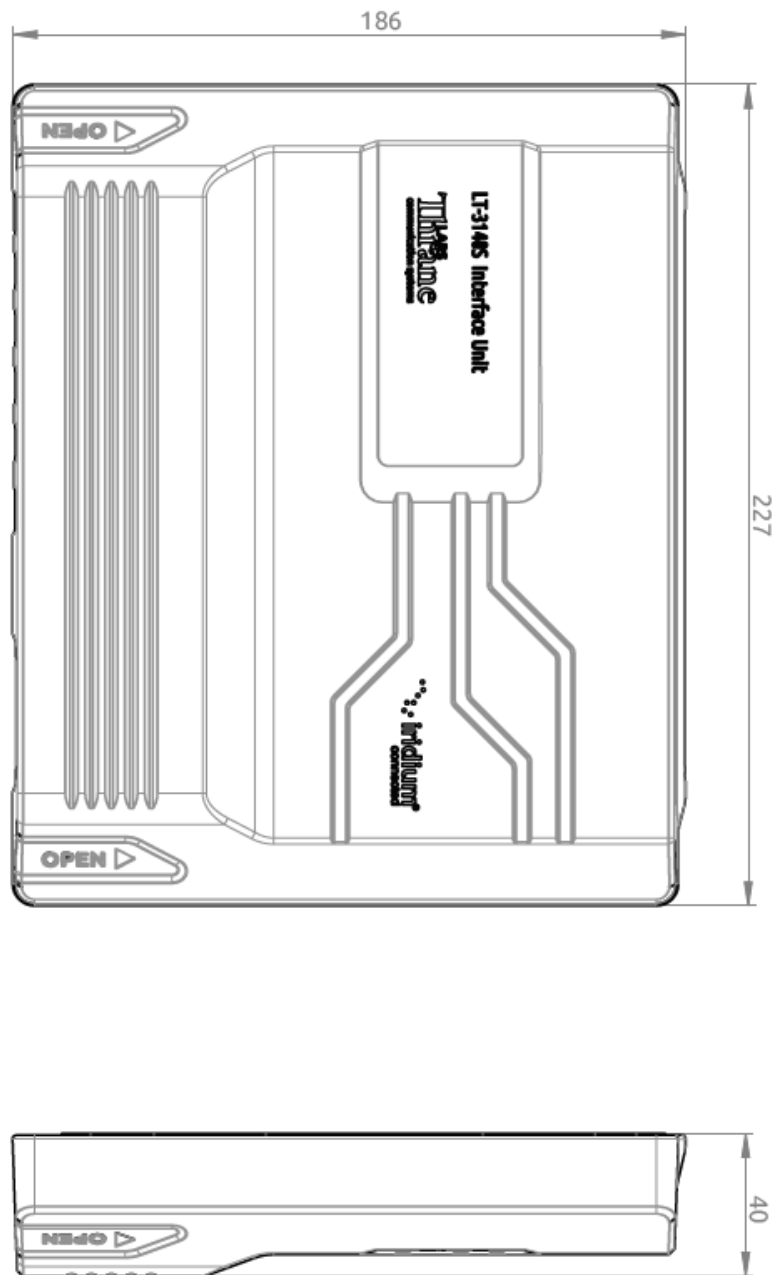
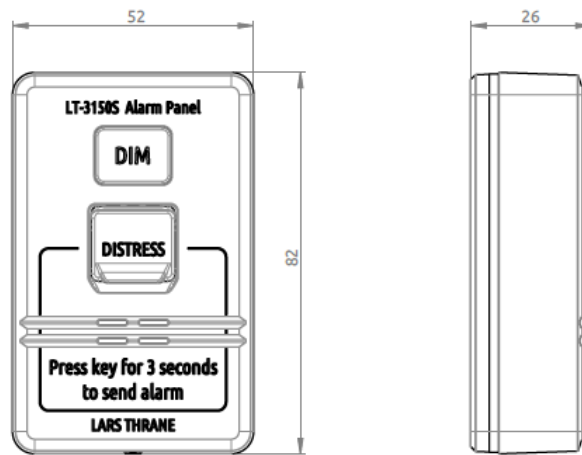

Figure 300: Outline Drawing: LT-3140S Interface Unit

**App. N - Outline Drawing: LT-3150S Alarm Panel**



*Figure 301: Outline Drawing: LT-3150S Alarm Panel*

**App. O - Outline Drawing: LT-3160S Printer Adapter**

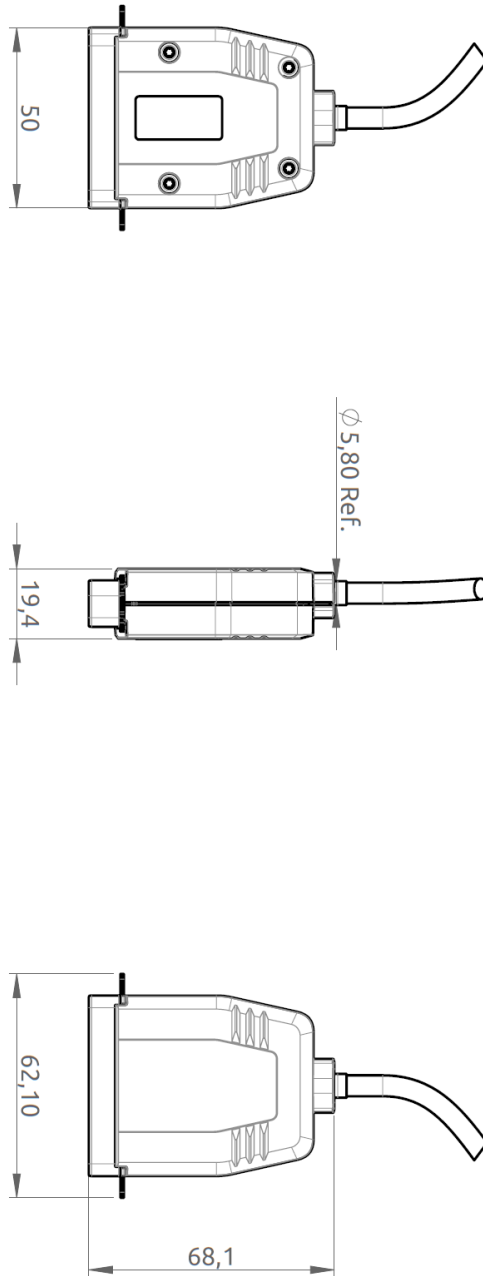

Figure 302: Outline Drawing: LT-3160S Printer Adapter

**App. P - Outline Drawing: Pole Mount, Antenna Unit**

**NOTE:** The Pole Mount (1.5" pipe), Antenna Unit interfaces to a pipe of maximum 1.5" (38.1 mm), measured outer diameter. The total weight of the Pole Mount is 0.18 kg (0.40 lbs).

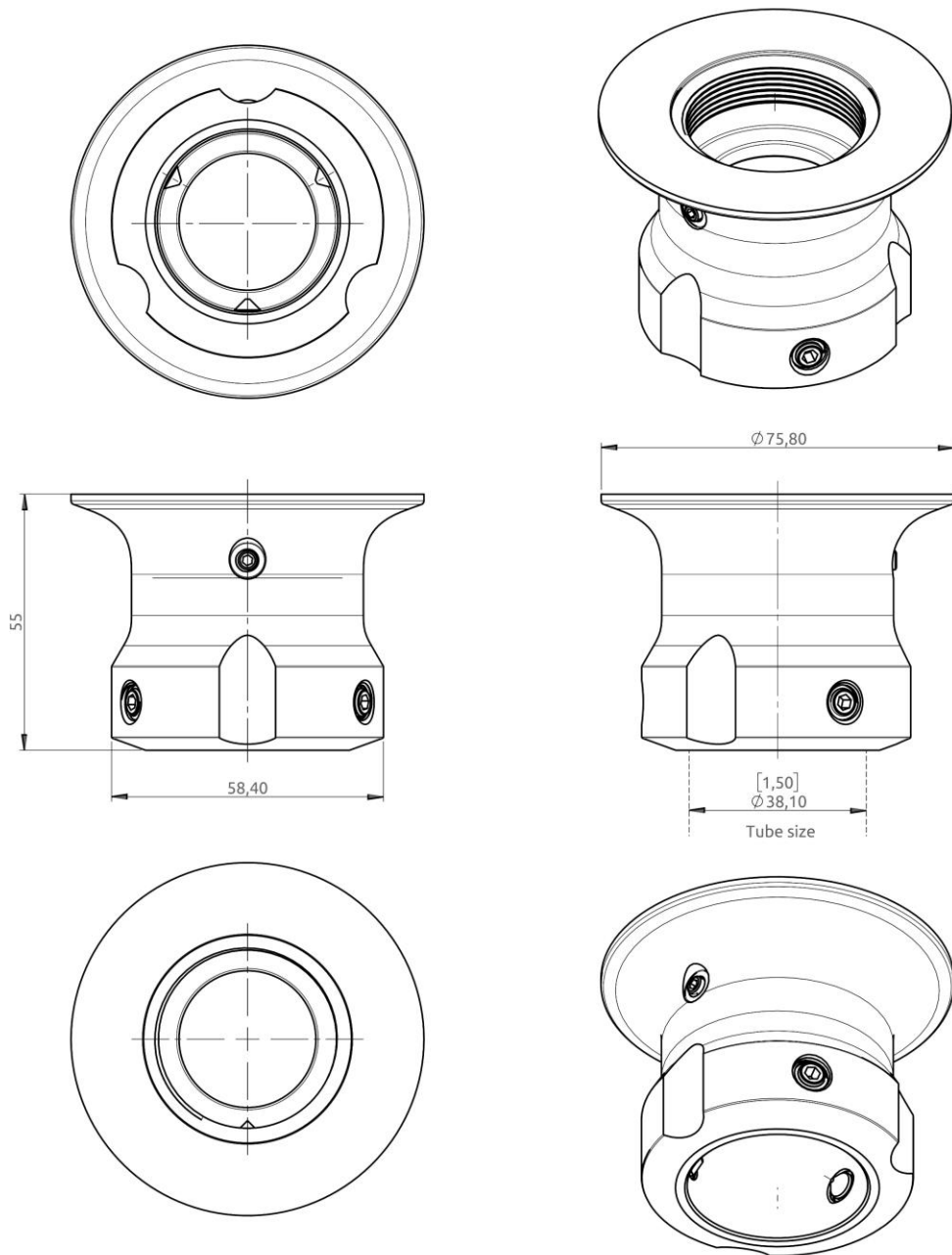

Figure 303: Outline Drawing: Pole Mount (1.5" pipe), Antenna Unit

**App. Q - Outline Drawing: Bracket Mount, Antenna Unit**

**NOTE:** The Bracket Mount (1.5" to 2.5" pipe), Antenna Unit interfaces to a pipe of maximum 2.5" (63.5 mm), measured outer diameter. The total weight of the Bracket Mount is 0.68 kg (1.50 lbs).

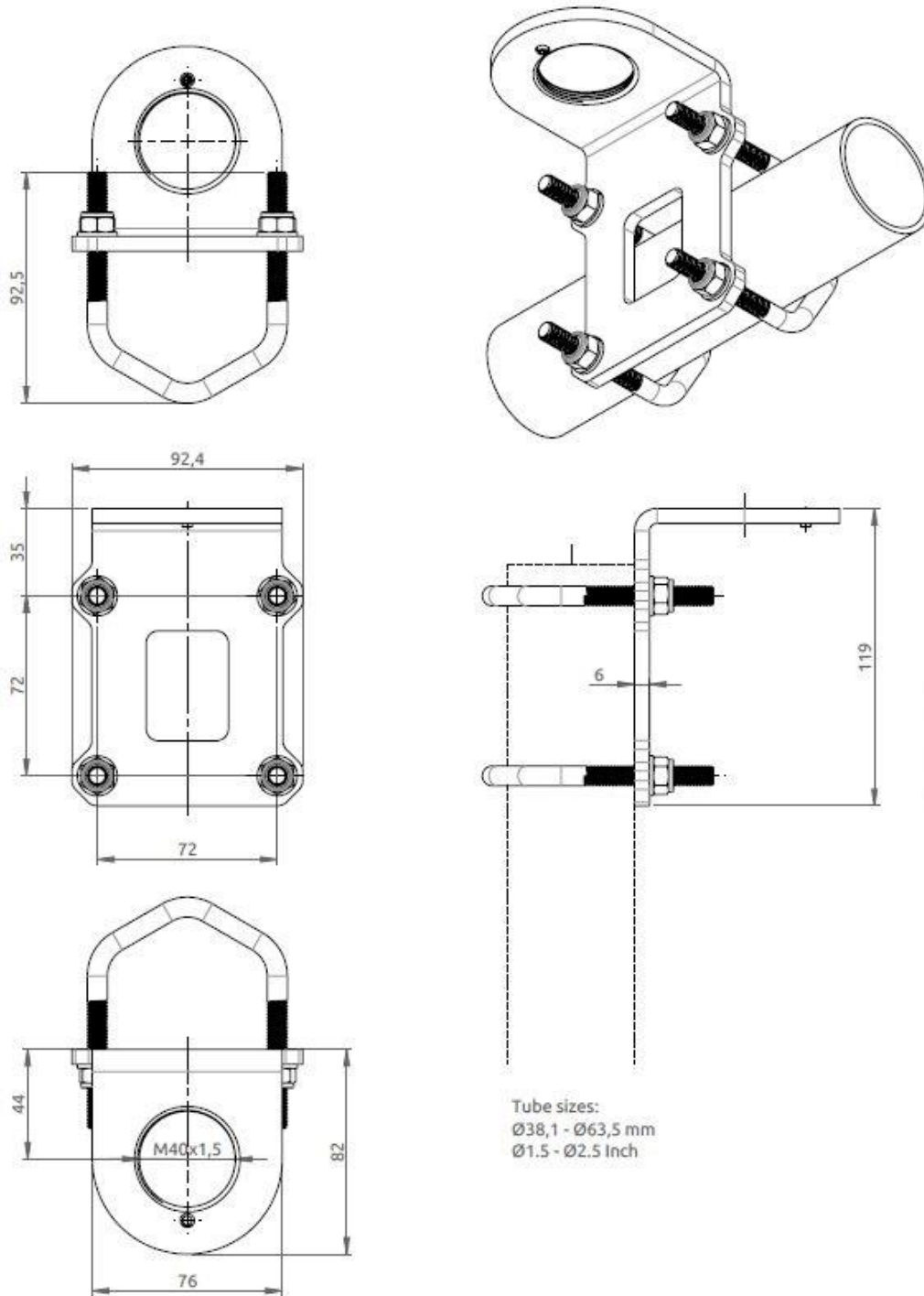
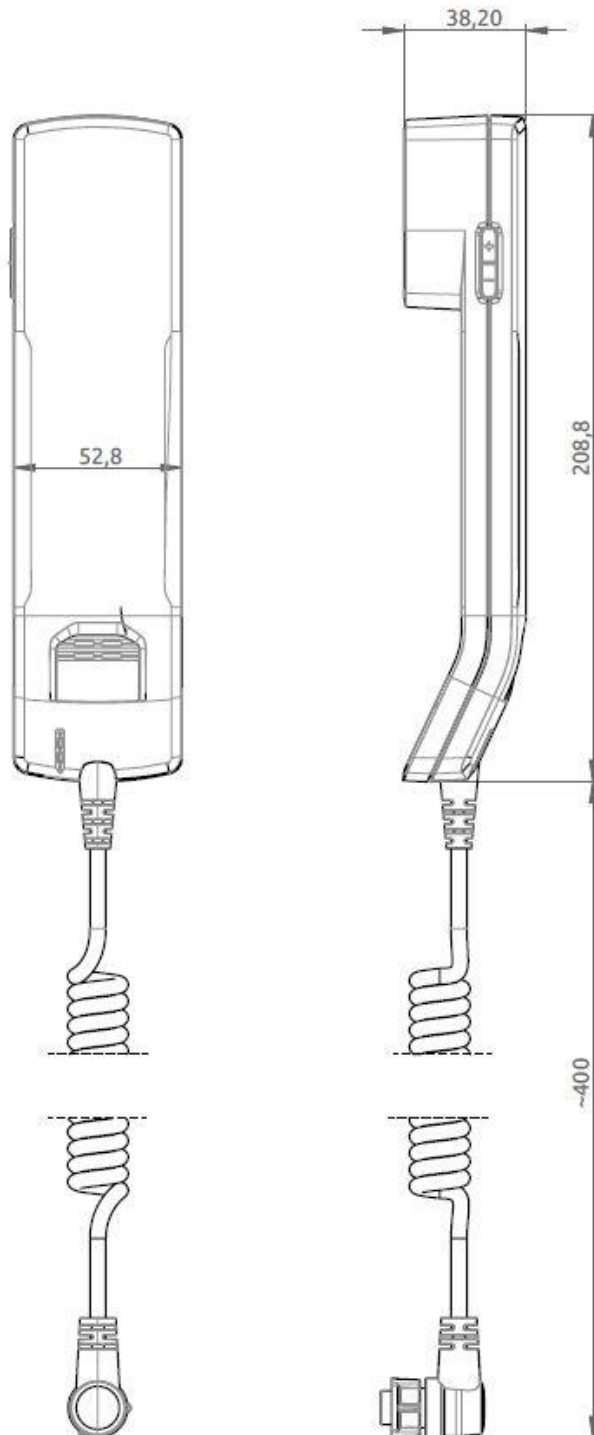

Figure 304: Outline Drawing: Bracket Mount (1.5" to 2.5" pipe), Antenna Unit

**App. R - Outline Drawing: LT-3120 Handset**



*Figure 305: Outline Drawing: LT-3120 Handset*

App. S - Outline Drawing: LT-3121 Cradle

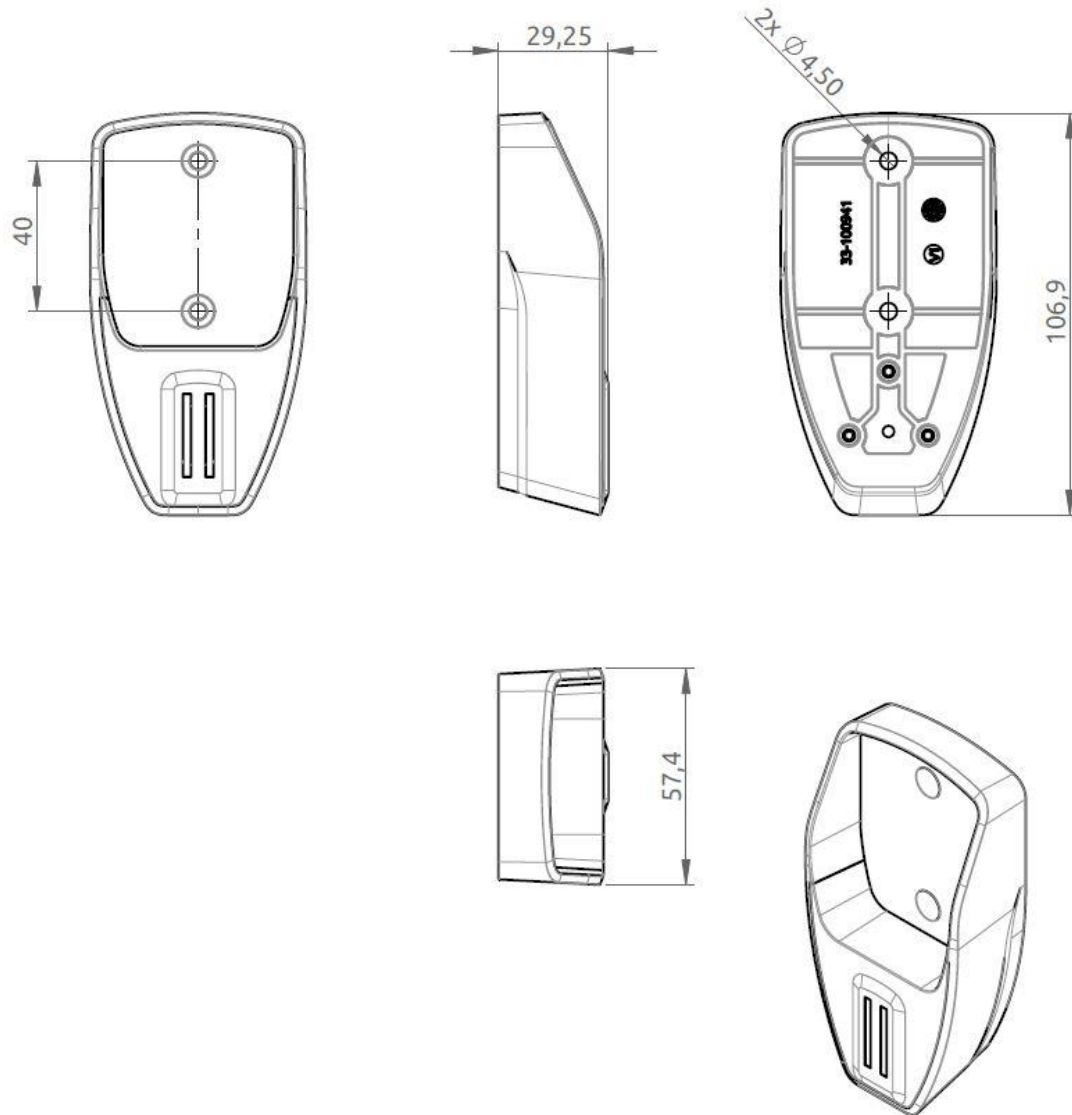

Figure 306: Outline Drawing: LT-3121 Cradle

## **App. T - Conformity**

### Radio Equipment Directive (RED) / CE

The LT-3100S GMDSS system is CE certified as stated in the EU Declaration of Conformity (DoC).

The EU DoC for the LT-3100S GMDSS system can be downloaded from the Lars Thrane A/S website, partner area (password required). Please contact Lars Thrane A/S for an electronic copy of the LT-3100S GMDSS system EU DoC.

The LT-3100S GMDSS system complies with the specifications of:

RED directive 2014/53/EU concerning Radio Equipment

### Wheelmark (MED)

The LT-3100S GMDSS system is Wheelmark certified as started in the MED Declaration of Conformity (DoC).

The MED DoC for the LT-3100S GMDSS system can be downloaded from the Lars Thrane A/S website, partner area (password required). Please contact Lars Thrane A/S for an electronic copy of the LT-3100S GMDSS system MED DoC. A printed hard copy of the MED DoC for the LT-3100S GMDSS system is delivered with the LT-3100S GMDSS system (incl. printed copies of MED Module B and D).

The LT-3100S GMDSS system complies with the specifications of:

MED directive 2014/90/EU concerning Marine Equipment  
Module B (EC Type Examination) and Module D (Approval og Quality System)

### Iridium GMDSS

The LT-3100S GMDSS system has obtained an Iridium GMDSS type approval.





**Lars Thrane A/S**

Skovlytoften 33

2840 Holte

Denmark

[www.thrane.eu](http://www.thrane.eu)